



EGLO
my light | my style



2024/25

TECHNICAL LIGHT SOLUTIONS

TECHNISCHE LICHTLÖSUNGEN
SOLUTIONS D'ÉCLAIRAGE TECHNIQUE



**Dear business partners and
faithful friends of EGLO,**

We are proud to present our comprehensive collection of innovative lighting solutions. With a focus on sleek design and premium performance, our products offer a variety of user-friendly controls and illumination options.

This year, we are revolutionising the way you light up your living spaces with our versatile downlights and LED panels with a wide range of functions. Experience the perfect balance of style and functionality with our lighting products.

**Geschätzte Geschäftspartner*innen,
treue EGLO Freund*innen,**

wir sind stolz darauf, Ihnen unsere umfassende Sammlung innovativer Lichtlösungen präsentieren zu können. Mit einem Fokus auf schlankem Design und überlegener Leistung bieten unsere Produkte eine Vielzahl von benutzerfreundlichen Steuerungsmöglichkeiten und Beleuchtungsoptionen.

In diesem Jahr revolutionieren wir die Art und Weise, wie Sie Ihre Wohnräume mit unseren vielseitigen Downlight-Lösungen und LED-Paneelen mit einer breiten Palette von Funktionen beleuchten. Erleben Sie die perfekte Balance aus Stil und Funktionalität mit unseren Produkten.

**Chers partenaires,
chers amis fidèles d'EGLO,**

Nous sommes fiers de vous présenter notre collection complète de solutions d'éclairage innovantes. Axés sur un design épuré et des performances supérieures, nos produits offrent des options d'éclairage multiples et conviviales.

Cette année, nous révolutionnons la façon dont vous éclairez vos espaces de vie avec nos solutions polyvalentes de Downlight et nos panneaux LED dotés d'un large éventail de fonctions. Découvrez l'équilibre parfait entre style et fonctionnalité.



CONTENT

INHALT
CONTENU

| | |
|--|------------|
| EGLO CONNECT.Z | 4 |
| EGLO CONNECT.Z EGLO CONNECT.Z | |
| EGLO EXPERT | 56 |
| EGLO EXPERT EGLO EXPERT | |
| - TRI-PROOF | 58 |
| - UNDERCABINET LUMINAIRES | 72 |
| - WALL & CEILING LUMINAIRES | 76 |
| - TUBES | 84 |
| KITCHEN & FUNCTIONAL LUMINAIRES | 92 |
| KÜCHEN- & FUNKTIONSLUCHTEN LUMINAIRES FONCTIONNELS & DE CUISINE | |
| TRACK SYSTEM | 98 |
| SCHIENENSYSTEM SYSTÈMES DE RAIL | |
| - EASY TRACK | 100 |
| - TRACK PLUS | 116 |
| LED PANEL LUMINAIRES | 128 |
| LED PANEELLEUCHTEN LUMINAIRES LAMBRIS LED | |
| - WITH FRAME..... | 134 |
| - FRAMELESS..... | 166 |
| - DECORATIVE..... | 176 |
| RECESSED DOWNLIGHTS | 186 |
| EINBAULEUCHTEN LUMINAIRES ENCASTRÉS | |
| - HIGH VOLTAGE..... | 188 |
| - LOW VOLTAGE | 216 |
| - WITH SOCKET | 220 |
| - FUEVA | 238 |
| SURFACE DOWNLIGHTS | 256 |
| AUFBAULEUCHTEN LUMINAIRES DE SURFACE | |
| - FUEVA | 258 |
| - DECORATIVE..... | 276 |
| LED STRIPES | 288 |
| LED-STREIFEN BANDES LED | |
| INDEX & LEGEND | 298 |
| INDEX & ERKLÄRUNG INDEX & LÉGENDE | |

connect.z

 zigbee  Bluetooth®

DISCOVER THE SMART WORLD





OVERVIEW



This product is available in different colors and shapes./ Dieser Artikel ist in unterschiedlichen Farben und Formen verfügbar./
Cet article est disponible en différentes couleurs et formes.

LIGHT UP YOUR WORLD!

Bringen Sie Licht in Ihren Alltag!

Illuminez votre quotidien !

Choose the perfect mood for your home from thousands of colors.
Wählen Sie aus tausenden von Farben die perfekte Stimmung für Ihr zuhause.
Choisissez parmi des milliers de couleurs l'ambiance parfaite pour votre maison.



Tunable White

Individual light from
50,000 white tones.
Individuelles Licht aus
50.000 Weißtönen.
Luminaire individuel à
50 000 tons de blanc.



Tunable White + RGB Colours

Diverse lighting selection from 50,000 white tones and 16 million colours.
Vielseitige Lichtauswahl aus 50.000 Weißtönen und 16 Mio. Farben.
Sélection étendue de luminaires à 50 000 tons de blanc et 16 millions de couleurs.



START QUICKLY AND EASILY WITH A REMOTE CONTROL CONNECTION

Starten Sie schnell und einfach mit einer Fernbedienungsverbindung
Démarez rapidement et facilement avec votre télécommande

You want to start with a remote control? No problem, of course all our smart lights can also be controlled without an app.

Sie wollen vorerst nur eine Fernbedienung verwenden? Kein Problem, natürlich sind all unsere smarten Leuchten auch ohne App steuerbar.

Vous ne voulez utiliser qu'une seule télécommande pour le moment ? Pas de problème, tous nos luminaires intelligents peuvent bien sûr être contrôlés sans application.



connect.z **remote**



connect.z **switch**



With the **connect.z remote**, our smart lights can be connected directly without an app or hub. **Create up to 3 groups** with the group buttons and connect **up to 50 luminaires with one remote control**.

Mit der **connect.z remote** lassen sich unsere smarten Leuchten direkt und ohne App oder Hub verbinden. **Erstellen Sie bis zu 3 Gruppen** mit den Gruppentasten und verbinden Sie **bis zu 50 Leuchten mit einer Fernbedienung**.

La télécommande **connect.z remote** permet de connecter directement nos luminaires intelligents, sans application ni hub. **Créez jusqu'à 3 groupes** avec les boutons de groupe et connectez **jusqu'à 50 luminaires avec une seule télécommande**.

With its **three buttons**, it not only enables luminaires to be switched **on and off**, but also **dimming** and changing the **light colour**. A **favourite setting** can also be saved on the switch.

Mit seinen **drei Tasten** ermöglicht er nicht nur das **Ein- und Ausschalten** von Leuchten, sondern auch das **Dimmen** und Ändern der **Lichtfarbe**. Zusätzlich ist am Switch eine **Favoriten-Einstellung** speicherbar.

Avec ses **trois touches**, il permet non seulement **d'allumer et d'éteindre** les luminaires, mais aussi de faire varier l'intensité **et la couleur** de la lumière. De plus, il est possible de **mémoriser un réglage favori** sur le commutateur.

WORKS WITH BLUETOOTH APP CONNECTION

Funktioniert mit Bluetooth-App Verbindung
L'application fonctionne avec une connexion Bluetooth

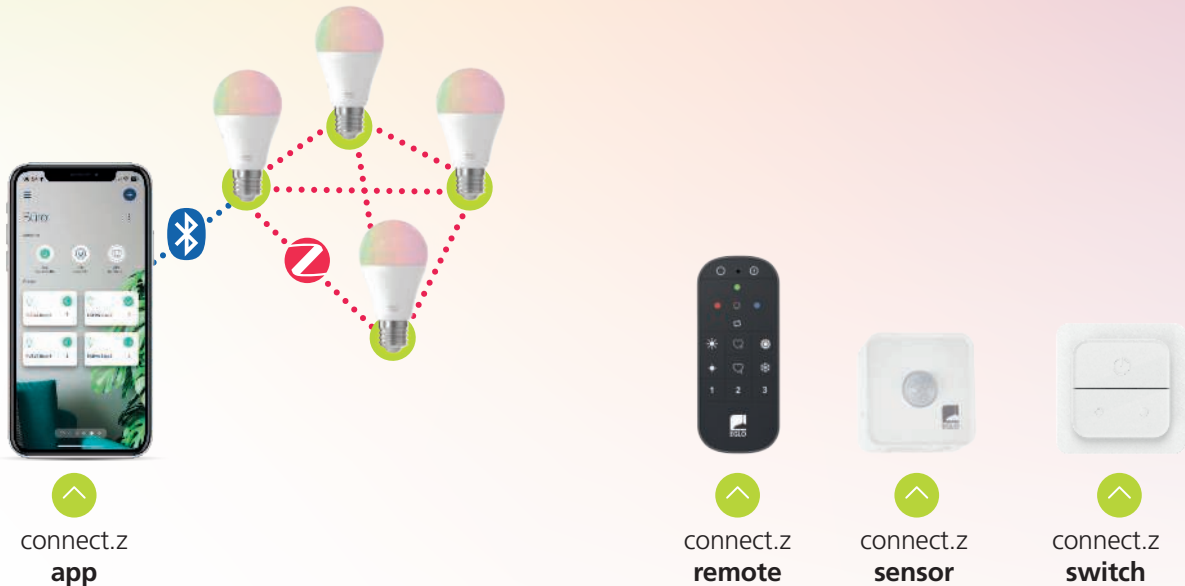

Connect our luminaires **directly with Bluetooth and our app - no hub is required.** The luminaires build a stable Zigbee network with each other, so up to 50 luminaires can be controlled using just a smartphone.

Verbinden Sie unsere Leuchten **direkt mit Bluetooth und unserer App - es ist kein Hub notwendig.** Die Leuchten bauen untereinander ein stabiles Zigbee Netzwerk auf, so können auch bis zu 50 Leuchten nur über das Smartphone gesteuert werden.

Connectez nos luminaires **directement avec Bluetooth et notre application - aucun hub n'est nécessaire.** Les luminaires établissent entre eux un réseau Zigbee stable, ce qui permet de contrôler jusqu'à 50 luminaires uniquement via le smartphone.

Also add **our smart accessories** (remote, sensor and switch) to the app for even more flexible control of your luminaires.

Fügen Sie auch **unsere smarten Accessories** (Remote, Sensor und Switch) in der APP hinzu, um eine noch flexiblere Steuerung Ihrer Leuchten zu ermöglichen.

Ajoute **également nos accessoires intelligents** (Remote, Sensor et Switch) dans l'APP pour un contrôle encore plus flexible de tes luminaires.



You already own connect-c luminaires from the previous system? What now? No problem! The previous connect-c products can be controlled together with the connect.z products via our app.

Sie besitzen bereits connect-c Leuchten des Vorgängersystems? Was nun? Kein Problem! Die bisherigen connect-c Produkte können zusammen mit den connect.z Produkten über unsere App gesteuert werden.

Vous possédez déjà des luminaires connect-c de l'ancien système ? Et maintenant ? Pas de problème ! Les produits connect-c précédents peuvent être contrôlés avec les produits connect.z via notre application.

MAKE MORE OF YOUR LIGHT: DISCOVER OUR APP

Machen Sie mehr aus Ihrem Licht: Entdecken Sie unsere App
Tirez le meilleur parti de votre lumière : découvrez notre application

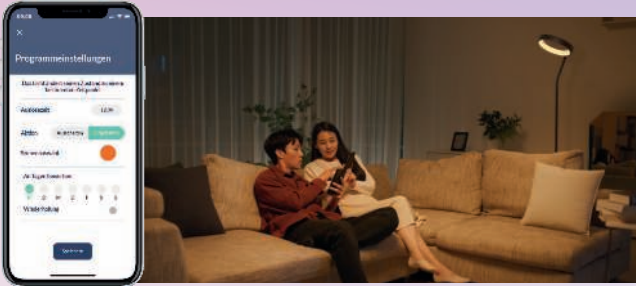

TIMERS AND CALENDARS TIMER UND KALENDER MINUTERIE ET CALENDRIER

Make your daily life easier with timers and calendars. Develop your own lighting routines and make your life easier.

Unterstützen Sie Ihren Alltag mit Timern und Kalendern. Entwickeln Sie eigene Lichtroutinen und machen Sie Ihr Leben leichter.

Facilitez-vous la vie à l'aide de la fonction minuterie et calendrier. Développez vos propres routines d'éclairage et facilitez votre vie.

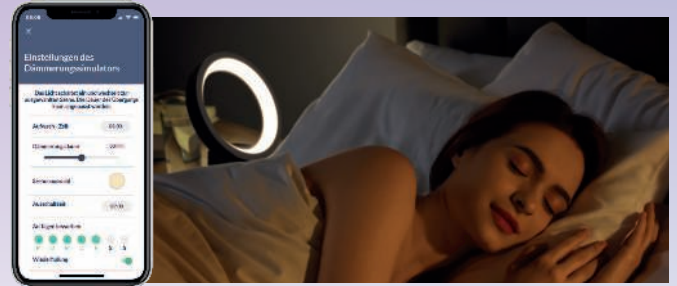

LIGHT ALARM CLOCK LICHTWECKER REVEIL LUMINEUX

You'd rather not start your day in a bad mood? Wake up relaxed with the simulated sunrise.

Keine Lust mit schlechter Laune in den Tag zu starten? Entspannt aufwachen mit dem simulierten Sonnenaufgang.

Pas envie de commencer la journée de mauvaise humeur ? Réveillez-vous en douceur grâce au simulateur de lever de soleil.



DISCO FUNCTION/MODE DISCOFUNKTION/MODUS FONCTION/MODE DISCO

For the perfect party mood, the disco function synchronises the light to the beat of your favourite songs.

Für die perfekte Partystimmung schaltet die Discofunktion das Licht passend zum Beat Ihres Lieblingssongs.

Pour une ambiance festive parfaite, la fonction disco enclenche le luminaire au rythme de votre chanson préférée.



PRESENCE SIMULATOR ANWESENHEITSSIMULATION SIMULATEUR DE PRESENCE

Protect your home with the convenient presence simulator. Variable time intervals allow the system to turn the luminaires on and off to simulate your presence at home and deter unwanted guests.

Schützen Sie Ihr Zuhause mit der komfortablen Anwesenheitssimulation. Dank variabler Zeitintervalle simuliert das System durch Ein- und Ausschalten der Beleuchtung die Anwesenheit im Haus und schreckt so ungebetene Gäste ab.

Protégez votre domicile à l'aide du très pratique simulateur de présence. Le système simule votre présence en allumant et en éteignant les lumières à intervalles variables et décourage ainsi les invités indésirables.

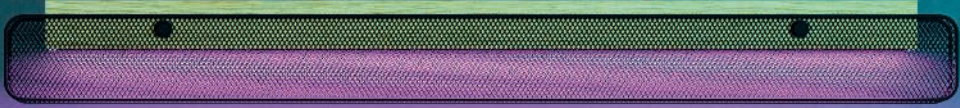
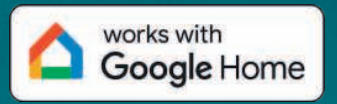

WORKS WITH GOOGLE HOME

Funktioniert mit Google Home
Funtionne avec Google Home

You can connect up to 6 of our connect.z luminaires directly to your Google Home smart speaker via Bluetooth.
Sie können bis zu 6 unserer connect.z Leuchten direkt mit Bluetooth mit Ihrem Google Home Smart Speaker verbinden.
Tu peux connecter jusqu'à 6 de nos luminaires connect.z directement par Bluetooth à ton Google Home Smart Speaker.





WORKS WITH ALEXA

Funktioniert mit Alexa
Fonctionne avec Alexa

Enjoy the comfort of creating your ideal living room lighting ambience with just one voice command.
Genießen Sie den Komfort, Ihr ideales Beleuchtungsambiente im Wohnzimmer mit nur einem Sprachbefehl zu gestalten.
Profitez du confort de créer votre ambiance d'éclairage idéale dans le salon avec une seule commande vocale.

with **integrated** Zigbee Hub
mit **integriertem** Zigbee Hub
avec Hub Zigbee **intégré**



Your Alexa has an **integrated Zigbee hub**? Perfect! You can connect our luminaires directly to Alexa.

Ihre Alexa hat einen **integrierten Zigbee Hub**? Optimal! Sie können unsere Leuchten direkt mit Alexa verbinden.

Votre Alexa a **un Hub Zigbee intégré**? C'est optimal! Vous pouvez connecter nos luminaires directement à Alexa.

 **zigbee**

with **separate** Zigbee Hub
mit **separatem** Zigbee Hub
avec Hub Zigbee **séparé**



Your Alexa **doesn't have an integrated Zigbee hub**? Don't worry! You can simply link an external Zigbee hub from another brand to your Alexa and then connect our luminaires to it.

Ihre Alexa **hat keinen integrierter Zigbee Hub**? Keine Sorge! Sie können einfach einen externen Zigbee Hub eines anderen Herstellers mit Ihrer Alexa verknüpfen und dann unsere Leuchten damit verbinden.

Votre Alexa **n'a pas de Hub Zigbee intégré**? Ne vous inquiétez pas! Vous pouvez simplement relier un hub Zigbee externe d'un autre fabricant à votre Alexa et y connecter ensuite nos luminaires.

Amazon Alexa and all related marks are trademarks of Amazon.com, Inc. or its affiliates.

 **zigbee**

WORKS WITH ZIGBEE

Funktioniert mit Zigbee

Fonctionne avec Zigbee



SMART HOME INTEGRATION EINBINDUNG SMART HOME INTÉGRATION DE LA MAISON INTELLIGENTE

You already have an existing Zigbee hub or a smart home system based on Zigbee? Perfect! Our luminaires can be integrated into any open Zigbee 3.0 system.

Sie haben bereits einen bestehenden Zigbee Hub bzw. ein Smarthome System welches auf Zigbee aufbaut? Optimal! Unsere Leuchten können in jedes offene Zigbee 3.0 System integriert werden.

Vous avez déjà un Hub Zigbee ou un système smarthome basé sur Zigbee ? C'est optimal ! Nos luminaires peuvent être intégrés dans n'importe quel système Zigbee 3.0 ouvert.

TALKS WITH HOMEY KOMMUNIZIERT MIT HOMEY COMMUNICATES WITH HOMEY

Do you want more than just control your lighting? Do you want to fully automate your home and have your EGLO luminaires interact in a network with a large number of intelligent devices from a wide range of manufacturers and different wireless standards? With Homey, this becomes a reality.

Sie streben nach mehr als der Kontrolle über Ihre Beleuchtung? Sie haben den Wunsch, Ihr Zuhause vollständig zu automatisieren und Ihre EGLO Leuchten in einem Netzwerk mit einer Vielzahl von intelligenten Geräten unterschiedlichster Hersteller und verschiedensten Funkstandards interagieren zu lassen? Mit Homey wird genau das zur Realität.

Tu aspiras à plus que le contrôle de ton éclairage ? Tu as envie d'automatiser entièrement ta maison et de faire interagir tes luminaires EGLO dans un réseau avec une multitude d'appareils intelligents de différents fabricants et avec les normes radio les plus diverses ? Avec Homey, c'est exactement ce qui devient réalité.



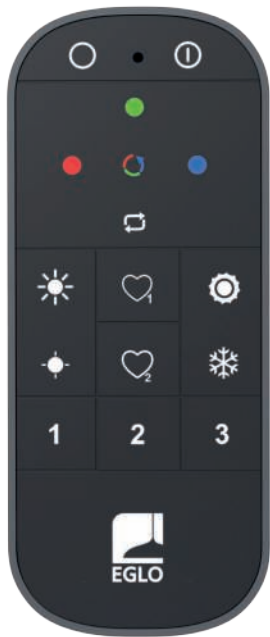

99099

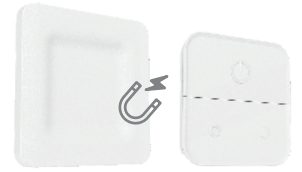

900116

The wall mount can be screwed or glued to smooth surfaces. The switch can be removed from its magnetic holder. The three buttons can be used to access various functions (on-off, dimming, CCT and RGB change).

Die Wandhalterung kann geschraubt oder an glatte Oberflächen geklebt werden. Der Schalter kann aus seiner magnetischen Halterung herausgenommen werden. Mit den drei Tasten können verschiedene Funktionen (Ein-Aus, Dimmen, CCT und RGB Wechsel) abgerufen werden.

Le support mural peut être vissé ou collé sur des surfaces lisses. L'interrupteur peut être retiré de son support magnétique. Les trois touches permettent d'accéder à différentes fonctions (marche/arrêt, variation, changement CCT et RGB).

99106



Mounting bracket incl.
Montagehalterung inkl.
Support de montage incl.

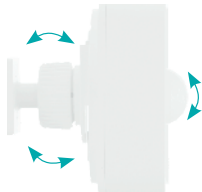

99106

120°, 12 m
20 sec. - 10 min.



IP44



900116

99099 CONNECT Z

remote control; plastic, grey
Fernbedienung; Kunststoff, grau
Télécommande; plastique, gris

L 122, B 54, H 18



AAA,
R03P



2 x 1,5V



9 002759 990992



B 54

99106 CONNECT-Z SENSOR

accessory; plastic, white
Zubehör; Kunststoff, weiss
Accessoires; plastique, blanc

L 75, H 75, A 70



AA,
LR6 HP



2900mAh,
1,5V



IP44



9 002759 991067

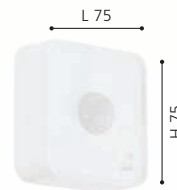

A 70

900116 CONNECT-Z SWITCH

accessory; plastic, white
Zubehör; Kunststoff, weiss
Accessoires; plastique, blanc

L 80, B 80, H 20



CR2032



9 008606 285761

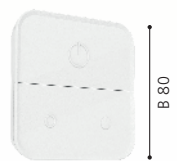

L 80



900764
LED



900766
LED



900764
LED

900766 CAROSSO-Z

recessed light; aluminium, white / plastic, white
Einbauleuchte; Alu, weiss / Kunststoff, weiss
luminaire encastrable; aluminium, blanc / plastique, blanc

H 28, Ø 93

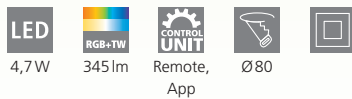

900764 CAROSSO-Z

recessed light; aluminium, black / plastic, white
Einbauleuchte; Alu, schwarz / Kunststoff, weiss
luminaire encastrable; aluminium, noir / plastique, blanc

H 28, Ø 93

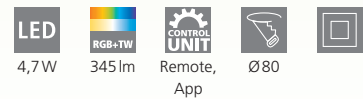



900765



900763



900765 CAROSSO-Z

recessed light; aluminium, white / plastic, white
 Einbauleuchte; Alu, weiss / Kunststoff, weiss
 luminaire encastrable; aluminium, blanc / plastique, blanc

L 93, B 93, H 25



900763 CAROSSO-Z

recessed light; aluminium, black / plastic, white
 Einbauleuchte; Alu, schwarz / Kunststoff, weiss
 luminaire encastrable; aluminium, noir / plastique, blanc

L 93, B 93, H 25

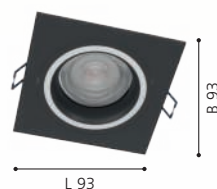
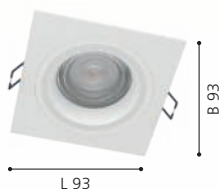
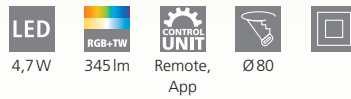



901169

LED



901168

LED

901169 CAROSSO-Z

surface-mounted light; aluminium, white / plastic, white
 Aufbauleuchte; Alu, weiss / Kunststoff, weiss
 luminaire en saillie; aluminium, blanc / plastique, blanc

H 95, Ø 80

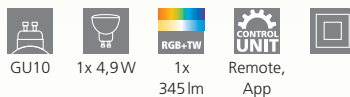

901168 CAROSSO-Z

surface-mounted light; aluminium, black / plastic, white
 Aufbauleuchte; Alu, schwarz / Kunststoff, weiss
 luminaire en saillie; aluminium, noir / plastique, blanc

H 95, Ø 80

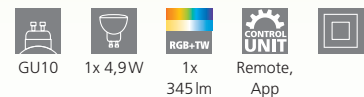



901168

LED





99671

LED





99669

LED



99672

LED



99671

LED



99669 SALICETO-Z

recessed light; aluminium, black
 Einbauleuchte; Alu, schwarz
 luminaire encastrable; aluminium, noir

H 46, Ø 88, ET 50



9 002759 996697



Ø 88

99671 SALICETO-Z

recessed light; aluminium, white
 Einbauleuchte; Alu, weiss
 luminaire encastrable; aluminium, blanc

H 46, Ø 88, ET 50

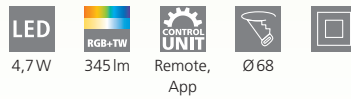

9 002759 996710



Ø 88

99672 SALICETO-Z

recessed light; aluminium, satin nickel
 Einbauleuchte; Alu, nickel-matt
 luminaire encastrable; aluminium, nickel mat

H 46, Ø 88, ET 50

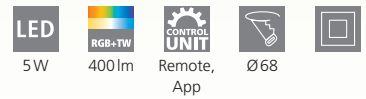

9 002759 996727



Ø 88



900481



900482



900483



900481 PADROGIANO-Z

ceiling light; steel, white / plastic, white
Deckenleuchte; Stahl, weiss / Kunststoff, weiss
plafonnier; acier, blanc / plastique, blanc

L 450, B 450, H 50



26,2W 3800lm Remote, App

900482 PADROGIANO-Z

ceiling light; steel, white / plastic, white
Deckenleuchte; Stahl, weiss / Kunststoff, weiss
plafonnier; acier, blanc / plastique, blanc

L 1200, B 300, H 50



42,5W 6000lm Remote, App

900483 PADROGIANO-Z

ceiling light; steel, white / plastic, white
Deckenleuchte; Stahl, weiss / Kunststoff, weiss
plafonnier; acier, blanc / plastique, blanc

L 450, B 450, H 50



27,9W 3600lm Remote, App



9 008606 244164



L 450

B 450



9 008606 244171



L 1200

B 300



9 008606 244188



L 450

B 450



900484

LED

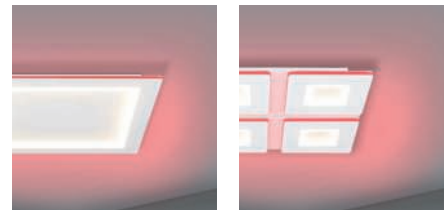

PADROGIANO-Z

The frame of these luminaires can switch between the RGB colors, the inner part can reproduce different white tones between 2700K and 6500K. By controlling via app or remote control, individual lighting effects can be set.

Der Rahmen dieser Leuchten kann zwischen den RGB Farbtönen wechseln, der Innenteil kann verschiedene Weißtöne zwischen 2700K und 6500K wiedergeben. Durch Steuerung per App oder Fernbedienung können so individuelle Lichtspiele eingestellt werden.

Le cadre de cette luminaires peut basculer entre es couleurs RVB, la partie intérieure peut reproduire différents tons blancs entre 2700K et 6500K. En contrôlant via l'application ou la télécommande, des effets d'éclairage individuels peuvent être définis.



900485

LED

900484 PADROGIANO-Z

ceiling light; steel, white / plastic, white
Deckenleuchte; Stahl, weiss / Kunststoff, weiss
plafonnier; acier, blanc / plastique, blanc

L 595, B 595, H 50



900485 PADROGIANO-Z

ceiling light; steel, white / plastic, white
Deckenleuchte; Stahl, weiss / Kunststoff, weiss
plafonnier; acier, blanc / plastique, blanc

L 1200, B 300, H 50

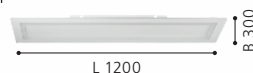



900486



PADROGIANO-Z

These lights have individually controllable light settings on the inside and outside of the frame.

Diese Leuchten verfügen über individuell steuerbare Lichteinstellungen der Rahmen innen und außen.

Ces lumières ont des paramètres d'éclairage contrôlables individuellement du cadre.



900487



900486 PADROGIANO-Z

ceiling light; steel, white / plastic, white
Deckenleuchte; Stahl, weiss / Kunststoff, weiss
plafonnier; acier, blanc / plastique, blanc

H 50, Ø 450



26,5W 3300lm Remote, App

900487 PADROGIANO-Z

ceiling light; steel, white / plastic, white
Deckenleuchte; Stahl, weiss / Kunststoff, weiss
plafonnier; acier, blanc / plastique, blanc

H 50, Ø 595



35W 4600lm Remote, App



9 008606 244218



9 008606 244225





900487

LED



900054

LED



900055

LED



900056

LED

900054 TURCONA-Z

ceiling light; steel, aluminium, white / plastic, white
Deckenleuchte; Stahl, Alu, weiss / Kunststoff, weiss
plafonnier; acier, aluminium, blanc / plastique, blanc

H 60, Ø 300

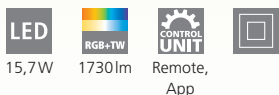

LED 15,7W RGB+TW 1730lm CONTROL UNIT Remote, App

900055 TURCONA-Z

ceiling light; steel, aluminium, white / plastic, white
Deckenleuchte; Stahl, Alu, weiss / Kunststoff, weiss
plafonnier; acier, aluminium, blanc / plastique, blanc

H 75, Ø 450



LED 22,4W RGB+TW 2490lm CONTROL UNIT Remote, App

900056 TURCONA-Z

ceiling light; steel, aluminium, white / plastic, white
Deckenleuchte; Stahl, Alu, weiss / Kunststoff, weiss
plafonnier; acier, aluminium, blanc / plastique, blanc

H 75, Ø 600



LED 34,2W RGB+TW 3980lm CONTROL UNIT Remote, App



9 008606 221905



9 008606 221912



9 008606 221929

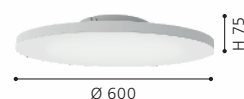



900055

LED

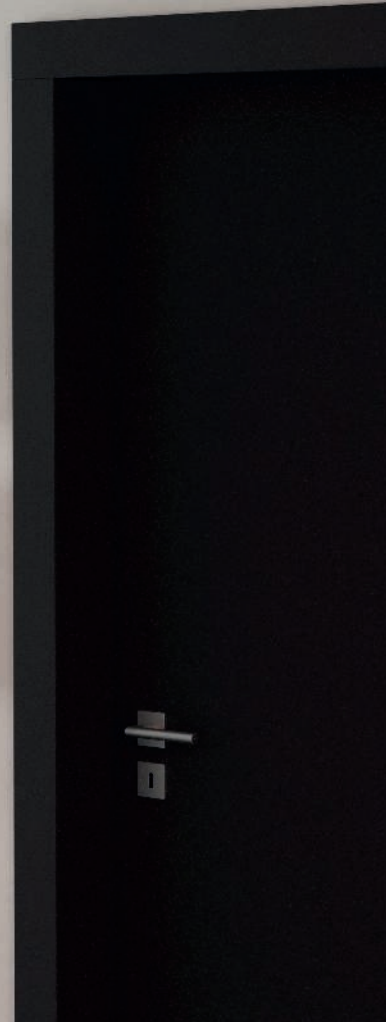



900758

LED



900759

LED

900758 SARSINA-Z

ceiling light; aluminium, steel, white / plastic, white
Deckenleuchte; Alu, Stahl, weiss / Kunststoff, weiss
plafonnier; aluminium, acier, blanc / plastique, blanc

H 52, Ø 450

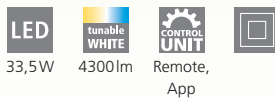

LED

33,5W



tunable
WHITE

4300lm



CONTROL
UNIT

Remote,
App



9 008606 264049



900759 SARSINA-Z

ceiling light; aluminium, steel, white / plastic, white
Deckenleuchte; Alu, Stahl, weiss / Kunststoff, weiss
plafonnier; aluminium, acier, blanc / plastique, blanc

H 52, Ø 600

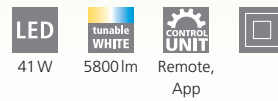

LED

41 W



tunable
WHITE

5800lm



CONTROL
UNIT

Remote,
App



9 008606 264056





900761

LED



900762

LED

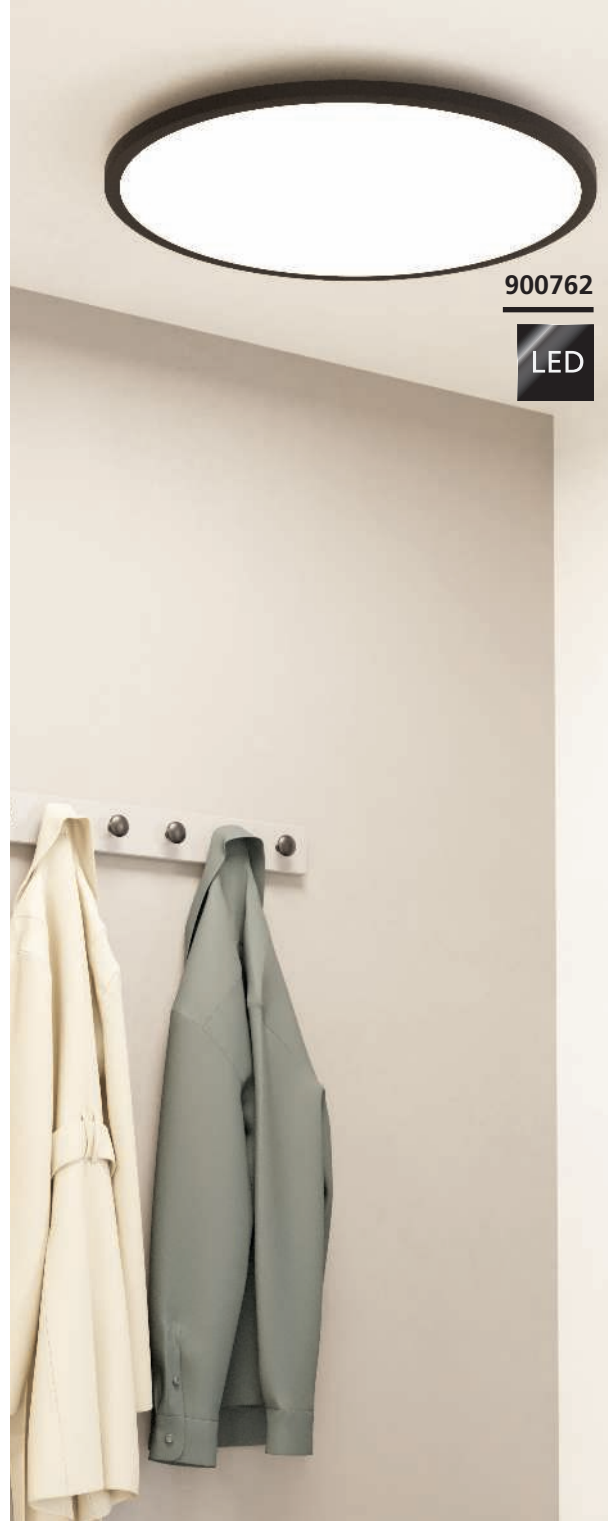

900762

LED

900761 SARSINA-Z

ceiling light; aluminium, steel, black / plastic, white
Deckenleuchte; Alu, Stahl, schwarz / Kunststoff, weiss
plafonnier; aluminium, acier, noir / plastique, blanc

H 52, Ø 450



33,5 W



4300 lm



Remote,
App



9 008606 264063



900762 SARSINA-Z

ceiling light; aluminium, steel, black / plastic, white
Deckenleuchte; Alu, Stahl, schwarz / Kunststoff, weiss
plafonnier; aluminium, acier, noir / plastique, blanc

H 52, Ø 600



41 W



5800 lm



Remote,
App



9 008606 264070





99639

LED



99548

LED



99549

LED

99639 HERRORA-Z

ceiling light; aluminium, white / plastic, white
Deckenleuchte; Alu, weiss / Kunststoff, weiss
plafonnier; aluminium, blanc / plastique, blanc

L 450, B 450, H 40



22W 2900lm Remote, App

99548 HERRORA-Z

ceiling light; aluminium, white / plastic, white
Deckenleuchte; Alu, weiss / Kunststoff, weiss
plafonnier; aluminium, blanc / plastique, blanc

L 595, B 595, H 40

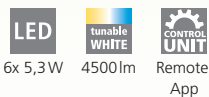

6x 5,3W 4500lm Remote, App

99549 HERRORA-Z

ceiling light; aluminium, white / plastic, white
Deckenleuchte; Alu, weiss / Kunststoff, weiss
plafonnier; aluminium, blanc / plastique, blanc

L 1200, B 300, H 40

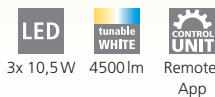

3x 10,5W 4500lm Remote, App



9 002759 996390

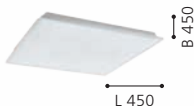

9 002759 995485

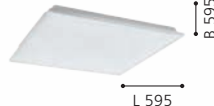

9 002759 995492





99639

LED





TURCONA-Z

Frameless luminaires.

Rahmenlose Leuchten.

Luminaires sans cadre.

900057 TURCONA-Z

ceiling light; steel, aluminium, white / plastic, white
Deckenleuchte; Stahl, Alu, weiss / Kunststoff, weiss
plafonnier; acier, aluminium, blanc / plastique, blanc

L 300, B 300, H 50

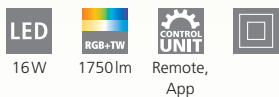

16W 1750lm Remote, App

900058 TURCONA-Z

ceiling light; steel, aluminium, white / plastic, white
Deckenleuchte; Stahl, Alu, weiss / Kunststoff, weiss
plafonnier; acier, aluminium, blanc / plastique, blanc

L 450, B 450, H 70



6x 3,8W 2400lm Remote, App

900059 TURCONA-Z

ceiling light; steel, aluminium, white / plastic, white
Deckenleuchte; Stahl, Alu, weiss / Kunststoff, weiss
plafonnier; acier, aluminium, blanc / plastique, blanc

L 600, B 600, H 75



6x 5,4W 4000lm Remote, App



9 008606 221936

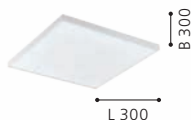

9 008606 221943

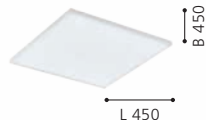

9 008606 221950

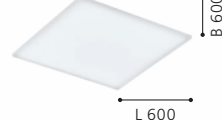



900062



900061



900062 TURCONA-Z

ceiling light; steel, aluminium, white / plastic, white
Deckenleuchte; Stahl, Alu, weiss / Kunststoff, weiss
plafonnier; acier, aluminium, blanc / plastique, blanc

L 1200, B 100, H 75

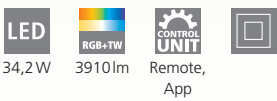

900061 TURCONA-Z

ceiling light; steel, aluminium, white / plastic, white
Deckenleuchte; Stahl, Alu, weiss / Kunststoff, weiss
plafonnier; acier, aluminium, blanc / plastique, blanc

L 1200, B 300, H 75

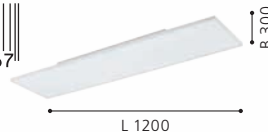
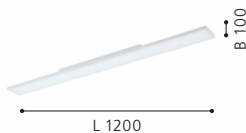
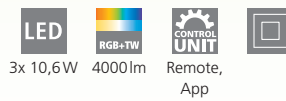



900044



900045



900046



900044 SALOBRENA-Z

ceiling light; aluminium, white / plastic, white
Deckenleuchte; Alu, weiss / Kunststoff, weiss
plafonnier; aluminium, blanc / plastique, blanc

L 300, B 300, H 50

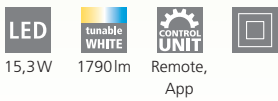

15,3W 1790lm Remote, App

900045 SALOBRENA-Z

ceiling light; aluminium, white / plastic, white
Deckenleuchte; Alu, weiss / Kunststoff, weiss
plafonnier; aluminium, blanc / plastique, blanc

L 450, B 450, H 50

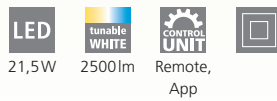

21,5W 2500lm Remote, App

900046 SALOBRENA-Z

ceiling light; aluminium, white / plastic, white
Deckenleuchte; Alu, weiss / Kunststoff, weiss
plafonnier; aluminium, blanc / plastique, blanc

L 595, B 595, H 50



33W 4100lm Remote, App



9 008606 221813

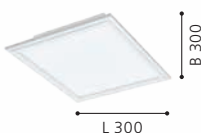

9 008606 221820

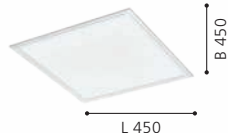

9 008606 221837

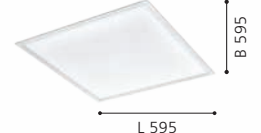



900047



900048



900047 SALOBRENA-Z

ceiling light; aluminium, white / plastic, white
Deckenleuchte; Alu, weiss / Kunststoff, weiss
plafonnier; aluminium, blanc / plastique, blanc

L 1200, B 300, H 50



900048 SALOBRENA-Z

ceiling light; aluminium, white / plastic, white
Deckenleuchte; Alu, weiss / Kunststoff, weiss
plafonnier; aluminium, blanc / plastique, blanc

L 1200, B 100, H 45

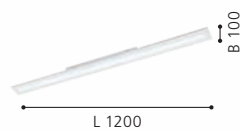
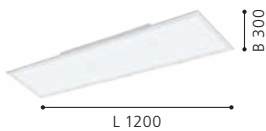
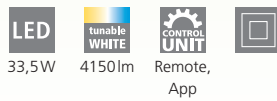

Zubehör inkludiert
Accessoires inclus



900049



900051



900052



900049 SALOBRENA-Z

ceiling light; aluminium, black / plastic, white
Deckenleuchte; Alu, schwarz / Kunststoff, weiss
plafonnier; aluminium, noir / plastique, blanc

L 300, B 300, H 50

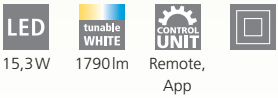

15,3W 1790lm Remote, App



9 008606 221868

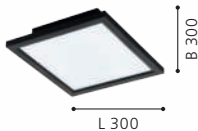

900051 SALOBRENA-Z

ceiling light; aluminium, black / plastic, white
Deckenleuchte; Alu, schwarz / Kunststoff, weiss
plafonnier; aluminium, noir / plastique, blanc

L 450, B 450, H 50



21,5W 2500lm Remote, App



9 008606 221875



900052 SALOBRENA-Z

ceiling light; aluminium, black / plastic, white
Deckenleuchte; Alu, schwarz / Kunststoff, weiss
plafonnier; aluminium, noir / plastique, blanc

L 595, B 595, H 50



33W 4100lm Remote, App



9 008606 221882





900053



900095



900053 SALOBRENA-Z

ceiling light; aluminium, black / plastic, white
 Deckenleuchte; Alu, schwarz / Kunststoff, weiss
 plafonnier; aluminium, noir / plastique, blanc

L 1200, B 300, H 50



900095 SALOBRENA-Z

ceiling light; aluminium, steel, black / plastic, white
 Deckenleuchte; Alu, Stahl, schwarz / Kunststoff, weiss
 plafonnier; aluminium, acier, noir / plastique, blanc

L 1200, B 100, H 45

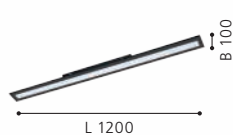

Zubehör inkludiert
 Accessoires inclus

900099, 900111, 900105

3 spots with one driver.

3 Spots mit einem Treiber.

3 spots avec une alimentation.

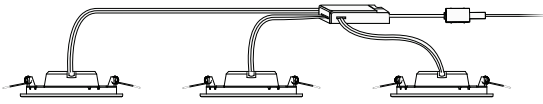

FUEVA-Z

H 26, Ø 85

recessed light
Einbauleuchte
luminaire encastrable

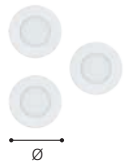

| Material / Colour | Size | Cutout | Quantity | Watt | Lumen | IP class | Item no. | EAN code |
|--|------------|--------|----------|----------|--------------|----------|---------------|-----------------|
| steel, white / plastic, white Stahl, weiss / Kunststoff, weiss acier, blanc / plastique, blanc | H 26, Ø 85 | Ø 75 | 3 | 3 x 2,8W | 3x 390lm | IP20/44 | 900099 | 9 008606 225569 |
| steel, satin nickel / plastic, white Stahl, nickel-matt / Kunststoff, weiss acier, nickel mat / plastique, blanc | H 26, Ø 85 | Ø 75 | 3 | 3 x 2,8W | 3x 390lm | IP20/44 | 900111 | 9 008606 225668 |
| steel, black / plastic, white Stahl, schwarz / Kunststoff, weiss acier, noir / plastique, blanc | H 26, Ø 85 | Ø 75 | 3 | 3 x 2,8W | 3x 390lm | IP20/44 | 900105 | 9 008606 225613 |



FUEVA-Z

H 26, Ø 120

recessed light
Einbauleuchte
luminaire encastrable



| Material / Colour | Size | Cutout | Watt | Lumen | IP class | Item no. | EAN code |
|--|-------------|--------|------|-----------|----------|---------------|-----------------|
| steel, white / plastic, white Stahl, weiss / Kunststoff, weiss acier, blanc / plastique, blanc | H 26, Ø 120 | Ø 105 | 5,4W | 700lm | IP20/44 | 900101 | 9 008606 225576 |
| steel, satin nickel / plastic, white Stahl, nickel-matt / Kunststoff, weiss acier, nickel mat / plastique, blanc | H 26, Ø 120 | Ø 105 | 5,4W | 700lm | IP20/44 | 900112 | 9 008606 225675 |
| steel, black / plastic, white Stahl, schwarz / Kunststoff, weiss acier, noir / plastique, blanc | H 26, Ø 120 | Ø 105 | 5,4W | 700lm | IP20/44 | 900106 | 9 008606 225620 |



IP44



FUEVA-Z

Water-splash protected luminaires are labelled with an IP value.

Spritzwassergeschützte Leuchten sind mittels IP-Wert gekennzeichnet.

Les luminaires protégés contre les projections d'eau sont identifiés au moyen de la valeur IP.

| | 0 | 1 | 2 | 3 |
|----|---|---|---|---|
| EU | X | X | ✓ | ✓ |
| FR | X | X | X | ✓ |



DIMMABLE
VIA REMOTE
AND APP

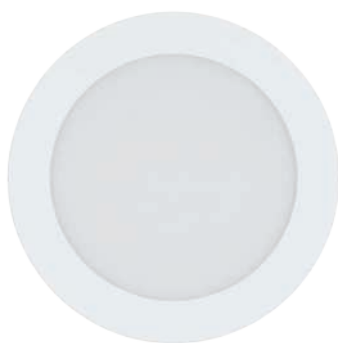









FUEVA-Z

H 26, Ø 165

recessed light
Einbauleuchte
luminaire encastrable



| Material / Colour | Size | Cutout | Watt | Lumen | IP class | Item no. | EAN code |
|--|-------------|--------|-------|--|----------|---------------|-----------------|
|  steel, white / plastic, white Stahl, weiss / Kunststoff, weiss acier, blanc / plastique, blanc | H 26, Ø 165 | Ø 155 | 10,5W |  1520lm  Remote, App | IP20/44 | 900102 | 9 008606 225583 |
|  steel, satin nickel / plastic, white Stahl, nickel-matt / Kunststoff, weiss acier, nickel mat / plastique, blanc | H 26, Ø 165 | Ø 155 | 10,5W |  1520lm  Remote, App | IP20/44 | 900113 | 9 008606 225682 |
|  steel, black / plastic, white Stahl, schwarz / Kunststoff, weiss acier, noir / plastique, blanc | H 26, Ø 165 | Ø 155 | 10,5W |  1520lm  Remote, App | IP20/44 | 900107 | 9 008606 225637 |











FUEVA-Z

Ø 216, ET 26

recessed light
Einbauleuchte
luminaire encastrable



| Material / Colour | Size | Cutout | Watt | Lumen | IP class | Item no. | EAN code |
|--|--------------|--------|-------|--|----------|--------------|-----------------|
|  aluminium, white / plastic, white Alu, weiss / Kunststoff, weiss aluminium, blanc / plastique, blanc | Ø 216, ET 26 | Ø 205 | 16,5W |  2100lm  Remote, App | IP20/44 | 98842 | 9 002759 988425 |
|  aluminium, satin nickel / plastic, white Alu, nickel-matt / Kunststoff, weiss aluminium, nickel mat / plastique, blanc | Ø 216, ET 26 | Ø 205 | 16,5W |  2100lm  Remote, App | IP20/44 | 98844 | 9 002759 988449 |
|  aluminium, black / plastic, white Alu, schwarz / Kunststoff, weiss aluminium, noir / plastique, blanc | Ø 216, ET 26 | Ø 205 | 16,5W |  2100lm  Remote, App | IP20/44 | 98846 | 9 002759 988463 |

DIMMABLE
VIA REMOTE
AND APP



FUEVA-Z

H 28, Ø 210

surface-mounted light
Aufbauleuchte
luminaire en saillie

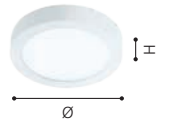

| Material / Colour | Size | Watt | Lumen | IP class | Item no. | EAN code |
|--|-------------|--------|--------|---------------------|---------------|-----------------|
| steel, white / plastic, white Stahl, weiss / Kunststoff, weiss acier, blanc / plastique, blanc | H 28, Ø 210 | 16,5 W | 2250lm | Remote, App IP44 | 900103 | 9 008606 225590 |
| steel, satin nickel / plastic, white Stahl, nickel-matt / Kunststoff, weiss acier, nickel mat / plastique, blanc | H 28, Ø 210 | 16,5 W | 2250lm | Remote, App IP44 | 900114 | 9 008606 225699 |
| steel, black / plastic, white Stahl, schwarz / Kunststoff, weiss acier, noir / plastique, blanc | H 28, Ø 210 | 16,5 W | 2250lm | Remote, App IP44 | 900108 | 9 008606 225644 |



FUEVA-Z

H 28, Ø 285

surface-mounted light
Aufbauleuchte
luminaire en saillie

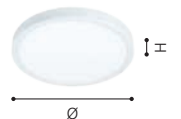

| Material / Colour | Size | Watt | Lumen | IP class | Item no. | EAN code |
|--|-------------|--------|--------|---------------------|--------------|-----------------|
| aluminium, white / plastic, white Alu, weiss / Kunststoff, weiss aluminium, blanc / plastique, blanc | H 28, Ø 285 | 19,5 W | 2500lm | Remote, App IP44 | 98843 | 9 002759 988432 |
| aluminium, satin nickel / plastic, white Alu, nickel-matt / Kunststoff, weiss aluminium, nickel mat / plastique, blanc | H 28, Ø 285 | 19,5 W | 2500lm | Remote, App IP44 | 98845 | 9 002759 988456 |
| aluminium, black / plastic, white Alu, schwarz / Kunststoff, weiss aluminium, noir / plastique, blanc | H 28, Ø 285 | 19,5 W | 2500lm | Remote, App IP44 | 98847 | 9 002759 988470 |





DIMMABLE
VIA REMOTE
AND APP



FUEVA-Z

L 210, B 210, H 28

surface-mounted light
Aufbauleuchte
luminaire en saillie

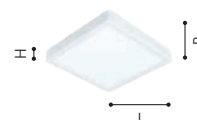

| Material / Colour | Size | Watt | Lumen | IP class | Item no. | EAN code |
|--|--------------------|-------|--------|---------------------|---------------|-----------------|
| steel, white / plastic, white Stahl, weiss / Kunststoff, weiss acier, blanc / plastique, blanc | L 210, B 210, H 28 | 16,5W | 2250lm | Remote, App IP44 | 900104 | 9 008606 225606 |
| steel, satin nickel / plastic, white Stahl, nickel-matt / Kunststoff, weiss acier, nickel mat / plastique, blanc | L 210, B 210, H 28 | 16,5W | 2250lm | Remote, App IP44 | 900115 | 9 008606 225705 |
| steel, black / plastic, white Stahl, schwarz / Kunststoff, weiss acier, noir / plastique, blanc | L 210, B 210, H 28 | 16,5W | 2250lm | Remote, App IP44 | 900109 | 9 008606 225651 |

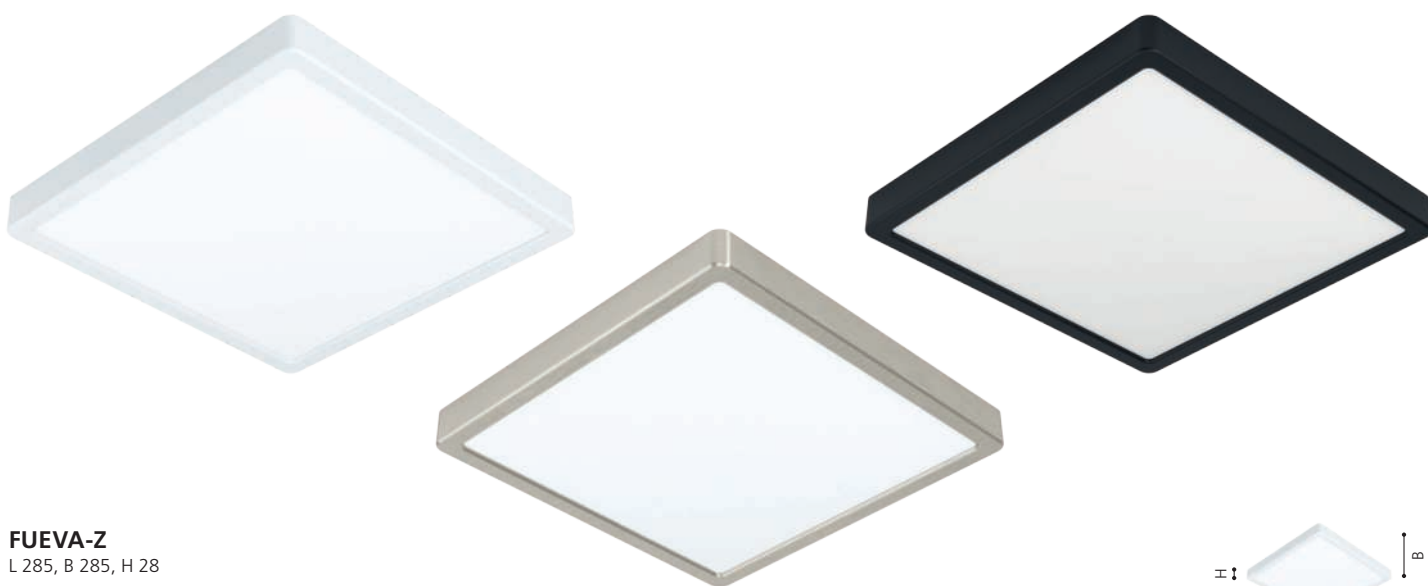

FUEVA-Z

L 285, B 285, H 28

surface-mounted light
Aufbauleuchte
luminaire en saillie

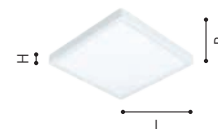

| Material / Colour | Size | Watt | Lumen | IP class | Item no. | EAN code |
|--|--------------------|-------|--------|---------------------|--------------|-----------------|
| aluminium, white / plastic, white Alu, weiss / Kunststoff, weiss aluminium, blanc / plastique, blanc | L 285, B 285, H 28 | 19,5W | 2500lm | Remote, App IP44 | 98849 | 9 002759 988494 |
| aluminium, satin nickel / plastic, white Alu, nickel-matt / Kunststoff, weiss aluminium, nickel mat / plastique, blanc | L 285, B 285, H 28 | 19,5W | 2500lm | Remote, App IP44 | 98852 | 9 002759 988524 |
| aluminium, black / plastic, white Alu, schwarz / Kunststoff, weiss aluminium, noir / plastique, blanc | L 285, B 285, H 28 | 19,5W | 2500lm | Remote, App IP44 | 98854 | 9 002759 988548 |



901463



IP44



901464



IP44



901465



IP44

901463 ROVITO-Z

ceiling light; plastic, black / plastic, white
Deckenleuchte; Kunststoff, schwarz / Kunststoff, weiss
plafonnier; plastique, noir / plastique, blanc

H 30, Ø 300

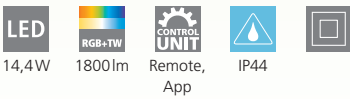

LED 14,4W
RGB+TW 1800lm
CONTROL UNIT Remote, App
IP44



9 008606 329700

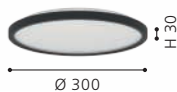

901464 ROVITO-Z

ceiling light; plastic, black / plastic, white
Deckenleuchte; Kunststoff, schwarz / Kunststoff, weiss
plafonnier; plastique, noir / plastique, blanc

H 30, Ø 390

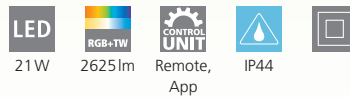

LED 21W
RGB+TW 2625lm
CONTROL UNIT Remote, App
IP44



9 008606 329717



901465 ROVITO-Z

ceiling light; plastic, black / plastic, white
Deckenleuchte; Kunststoff, schwarz / Kunststoff, weiss
plafonnier; plastique, noir / plastique, blanc

H 32, Ø 500

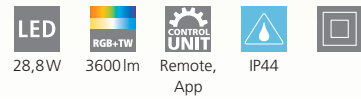

LED 28,8W
RGB+TW 3600lm
CONTROL UNIT Remote, App
IP44



9 008606 329724





901466



IP44

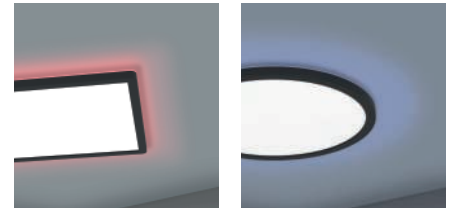

ROVITO-Z

These lights have individually controllable light settings on the inside and outside of the frame.

Diese Leuchten verfügen über individuell steuerbare Lichteinstellungen der Rahmen innen und außen.

Ces lumières ont des paramètres d'éclairage contrôlables individuellement du cadre.

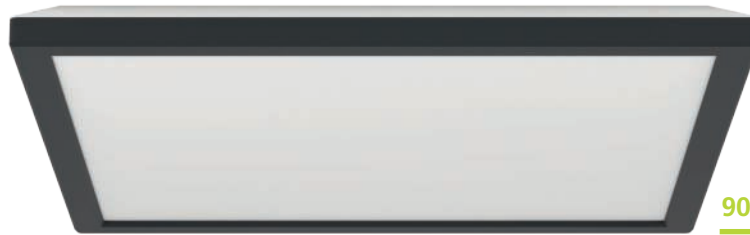

901467



IP44

901466 ROVITO-Z

ceiling light; plastic, black / plastic, white
Deckenleuchte; Kunststoff, schwarz / Kunststoff, weiss
plafonnier; plastique, noir / plastique, blanc

L 290, B 290, H 30



14,4 W



2000 lm



Remote,
App



IP44

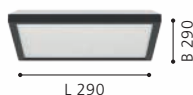

901467 ROVITO-Z

ceiling light; plastic, black / plastic, white
Deckenleuchte; Kunststoff, schwarz / Kunststoff, weiss
plafonnier; plastique, noir / plastique, blanc

L 390, B 390, H 30



21 W



3000 lm



Remote,
App



IP44



9 008606 329748

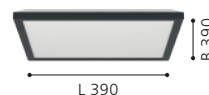

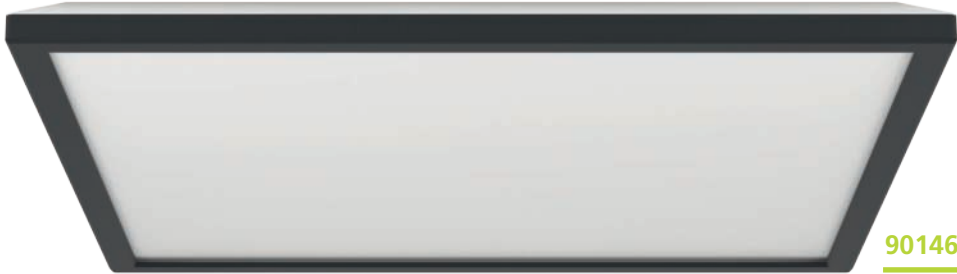

901468



IP44



901469



IP44

901468 ROVITO-Z

ceiling light; plastic, black / plastic, white
 Deckenleuchte; Kunststoff, schwarz / Kunststoff, weiss
 plafonnier; plastique, noir / plastique, blanc

L 500, B 500, H 32



28,8W 4200lm Remote, App



9 008606 329755

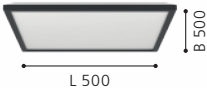

901469 ROVITO-Z

ceiling light; plastic, black / plastic, white
 Deckenleuchte; Kunststoff, schwarz / Kunststoff, weiss
 plafonnier; plastique, noir / plastique, blanc

L 570, B 300, H 30



21W 3000lm Remote, App



9 008606 329762





ROVITO-Z

These lights have individually controllable light settings on the inside and outside of the frame.

Diese Leuchten verfügen über individuell steuerbare Lichteinstellungen der Rahmen innen und außen.

Ces lumières ont des paramètres d'éclairage contrôlables individuellement du cadre.

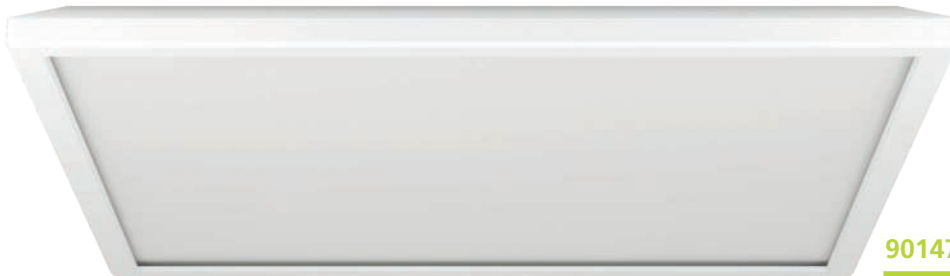

901476



IP44



901477



IP44

901476 ROVITO-Z

ceiling light; plastic, white / plastic, white
Deckenleuchte; Kunststoff, weiss / Kunststoff, weiss
plafonnier; plastique, blanc / plastique, blanc

L 500, B 500, H 32



28,8 W



4200 lm



Remote,
App



IP44



901477 ROVITO-Z

ceiling light; plastic, white / plastic, white
Deckenleuchte; Kunststoff, weiss / Kunststoff, weiss
plafonnier; plastique, blanc / plastique, blanc

L 570, B 300, H 30



21 W



3000 lm



Remote,
App



IP44



9 008606 329830





901471



IP44



901472



IP44



901473



IP44

901471 ROVITO-Z

ceiling light; plastic, white / plastic, white
Deckenleuchte; Kunststoff, weiss / Kunststoff, weiss
plafonnier; plastique, blanc / plastique, blanc

H 30, Ø 300

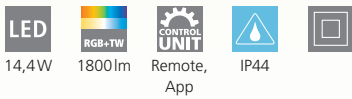

14,4W 1800lm Remote, App



9 008606 329779



901472 ROVITO-Z

ceiling light; plastic, white / plastic, white
Deckenleuchte; Kunststoff, weiss / Kunststoff, weiss
plafonnier; plastique, blanc / plastique, blanc

H 30, Ø 390

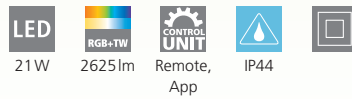

21W 2625lm Remote, App



9 008606 329786



901473 ROVITO-Z

ceiling light; plastic, white / plastic, white
Deckenleuchte; Kunststoff, weiss / Kunststoff, weiss
plafonnier; plastique, blanc / plastique, blanc

H 32, Ø 500

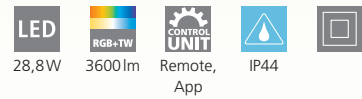

28,8W 3600lm Remote, App



9 008606 329793





901474



IP44

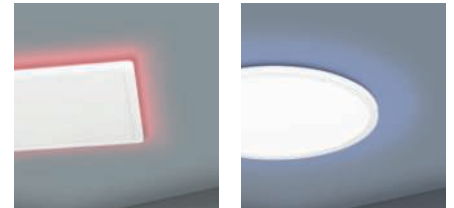

ROVITO-Z

These lights have individually controllable light settings on the inside and outside of the frame.

Diese Leuchten verfügen über individuell steuerbare Lichteinstellungen der Rahmen innen und außen.

Ces lumières ont des paramètres d'éclairage contrôlables individuellement du cadre.



901475



IP44

901474 ROVITO-Z

ceiling light; plastic, white / plastic, white
Deckenleuchte; Kunststoff, weiss / Kunststoff, weiss
plafonnier; plastique, blanc / plastique, blanc

L 290, B 290, H 30



14,4 W



2000 lm



Remote,
App



IP44



901475 ROVITO-Z

ceiling light; plastic, white / plastic, white
Deckenleuchte; Kunststoff, weiss / Kunststoff, weiss
plafonnier; plastique, blanc / plastique, blanc

L 390, B 390, H 30



21 W



3000 lm



Remote,
App



IP44



9 008606 329809



L 290



9 008606 329816



L 290



901108



NEON-STRIPE-Z

Fixing clips are included in the scope of delivery.

Befestigungsclips im Lieferumfang enthalten.

Les clips de fixation sont inclus dans la livraison.



901109



901108 NEON-STRIPE-Z

bar/strip light; plastic, white
 Leuchtband/-stab; Kunststoff, weiss
 bande lumineuse / bâton l; plastique, blanc

L 3000, B 18, H 8



901109 NEON-STRIPE-Z

bar/strip light; plastic, white
 Leuchtband/-stab; Kunststoff, weiss
 bande lumineuse / bâton l; plastique, blanc

L 5000, B 18, H 8



9 008606 295265



L 3000



9 008606 295272



L 5000



901109

LED



99684, 99685

These LED strips are very flexible and are perfect for shaping.

Diese LED-Streifen sind sehr flexibel und eignen sich perfekt zum Formen.

Ces bandes LED sont très flexibles et conviennent parfaitement à la mise en forme.



99684

Driver included.
Treiber inkludiert.
Chauffeur inclus.

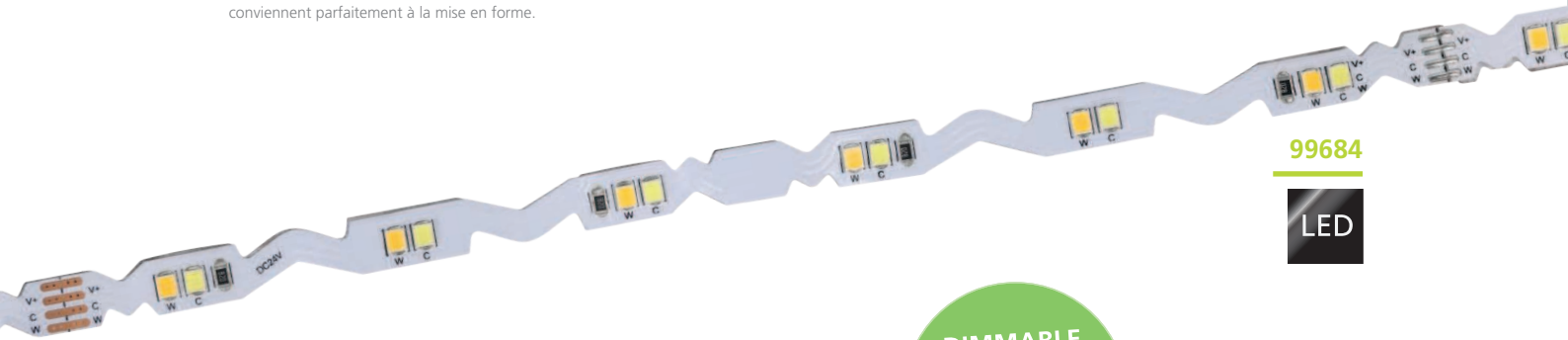
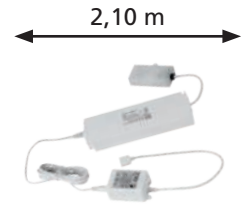

99684



99685

Extension for starter set 99684 without driver.

Erweiterung für Starterset 99684 ohne Treiber.

Rallonge pour kit de démarrage 99684 sans pilote.



99685



99684 LED STRIPE-Z

bar/strip light; plastic, white
Leuchtband/-stab; Kunststoff, weiss
bande lumineuse / bâton l; plastique, blanc

L 3000, B 8



13,5W 1450lm Remote, App



9 002759 996840



L 3000

99685 LED STRIPE-Z

bar/strip light; plastic, white
Leuchtband/-stab; Kunststoff, weiss
bande lumineuse / bâton l; plastique, blanc

L 2000, B 8

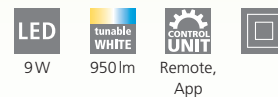

9W 950lm Remote, App



9 002759 996857



L 2000

1,50 m



99686

Driver included.
Treiber inkludiert.
Chauffeur inclus.



99686



3,40 m



99687

Driver included.
Treiber inkludiert.
Chauffeur inclus.



99687



99687



99686 LED STRIPE-Z

bar/strip light; plastic, white
Leuchtband/-stab; Kunststoff, weiss
bande lumineuse / bâton l; plastique, blanc

L 5000, B 12

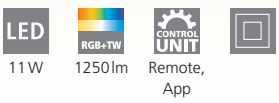

11W 1250lm Remote, App



9 002759 996864



L 5000

99687 LED STRIPE-Z

bar/strip light; plastic, white
Leuchtband/-stab; Kunststoff, weiss
bande lumineuse / bâton l; plastique, blanc

L 8000, B 12

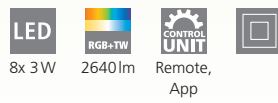

8x 3W 2640lm Remote, App



9 002759 996871



L 8000





EGLO EXPERT

ADVANTAGES

- > HIGH-QUALITY MOISTURE-PROOF, WALL, CEILING AND UNDER-CABINET LUMINAIRES FOR KITCHENS, GARAGES AND WAREHOUSES
 - > THE RANGE IS INNOVATIVE AND PERFECTED DOWN TO THE LAST DETAIL
 - > LARGE SELECTION OF LED TUBE BULBS
 - > PREMIUM MODELS IN EEI CLASS C OFFER HIGH PERFORMANCE WITH LOW ENERGY CONSUMPTION
-

VORTEILE

- > HOCHWERTIGE FEUCHTRAUM-, WAND-, DECKEN- UND UNTERBAULEUCHTEN FÜR KÜCHEN, GARAGEN UND LAGERHALLEN
 - > INNOVATIVES UND PERFEKTIONIERTES SORTIMENT BIS INS DETAIL
 - > GROSSE AUSWAHL AN LED TUBE LEUCHTMITTELN
 - > PREMIUMMODELLE IN EEI KLASSE C BIETEN HOHE LEISTUNG BEI NIEDRIGEM ENERGIEVERBRAUCH
-

AVANTAGES

- > DES LUMINAIRES DE HAUTE QUALITÉ POUR LOCAUX HUMIDES, DES APPLIQUES MURALES, DES PLAFONNIERS ET DES LUMINAIRES ENCASTRÉS POUR LES CUISINES, LES GARAGES ET LES ENTREPÔTS.
- > L'ASSORTIMENT EST INNOVANT ET PERFECTIONNÉ JUSQUE DANS LES MOINDRES DÉTAILS
- > GRAND CHOIX D'AMPOULES À TUBE LED
- > LES MODÈLES HAUT DE GAMME DE CLASSE EEI C OFFRENT DES PERFORMANCES ÉLEVÉES POUR UNE FAIBLE CONSOMMATION D'ÉNERGIE





EGLO EXPERT

TRI-PROOF

ADVANTAGES

- > **NEWLY DEVELOPED DAMP-PROOF LUMINAIRES** - for use in damp or wet environments such as bathrooms, kitchens, garages, cellars or outdoor areas
- > **WATERPROOF AND MOISTURE-RESISTANT** - special seals and gaskets protect against moisture and water, making them ideal for environments where conventional luminaires could be damaged, all damp-proof luminaires are certified to at least IP65 class, the Ammonia series to IP69K class
- > **DURABILITY** - robust and resistant materials guarantee safety against moisture, shocks and vibrations, long service life even under demanding conditions
- > **VERSATILITY** - available in different sizes, shapes and light intensities, can be used both indoors and outdoors, suitable for different applications and environments
- > **ENERGY EFFICIENCY** - most of our models are EEI class C, consuming less energy and reducing operating costs with high lumen output
- > **EASY INSTALLATION AND MAINTENANCE** - simple installation with minimal maintenance, quick and easy maintenance and cleaning
- > **CIRCUIT BOARDS AND REPLACEABLE LIGHT SOURCES** - Basic series is supplied with replaceable LED tubes, all other series have an integrated LED circuit board

VORTEILE

- > **NEU ENTWICKELTE FEUCHTRAUMLEUCHTEN** - Einsatz in feuchten oder nassen Umgebungen wie Badezimmern, Küchen, Garagen, Kellern oder Außenbereichen
- > **WASSERDICHT UND FEUCHTIGKEITSBESTÄNDIG** - spezielle Dichtungen und Abdichtungen schützen vor Feuchtigkeit und Wasser, dadurch ideal für Umgebungen, in denen herkömmliche Leuchten beschädigt werden können, alle Feuchtraumleuchten sind min. in IP65-Klasse, die Ammoniak Serie in IP69K-Klasse zertifiziert
- > **LANGLEBIGKEIT** - robuste und widerstandsfähige Materialien garantieren sowohl Sicherheit gegenüber Feuchtigkeit, Stößen und Vibrationen, als auch eine lange Lebensdauer unter anspruchsvollen Bedingungen
- > **VIELSEITIGKEIT** - in verschiedenen Größen, Formen und Lichtstärken erhältlich, können sowohl im Innen- als auch im Außenbereich eingesetzt werden, eignen sich für verschiedene Anwendungen und Umgebungen
- > **ENERGIEEFFIZIENZ** - unsere Modelle sind zum größten Teil in EEI-Klasse C erhältlich, verbrauchen weniger Energie und senken die Betriebskosten bei hohem Lumenoutput
- > **EINFACHE INSTALLATION UND WARTUNG** - einfache Installation, schnelle und unkomplizierte Wartung und Reinigung
- > **PLATINEN UND WECHSELBARE LEUCHTMITTEL** - Basic Serie wird inklusive wechselbarer LED Tubes geliefert, alle anderen Serien haben eine integrierte LED Platine verbaut

AVANTAGES

- > **LUMINAIRES POUR LOCAUX HUMIDES NOUVELLEMENT DÉVELOPPÉS** - utilisation dans des environnements humides ou mouillés comme les salles de bains, les cuisines, les garages, les caves ou les espaces extérieurs
- > **ÉTANCHÉITÉ ET RÉSISTANCE À L'HUMIDITÉ** - des joints et des garnitures spéciaux protègent contre l'humidité et l'eau, ce qui est idéal pour les environnements où les luminaires traditionnels pourraient être endommagés, tous les luminaires pour locaux humides sont certifiés au minimum en classe IP65, la série Ammoniak en classe IP69K
- > **DURABILITÉ** - des matériaux robustes et résistants garantissent la sécurité contre l'humidité, les chocs et les vibrations, longue durée de vie même dans des conditions exigeantes
- > **POLYVALENCE** - disponibles en différentes tailles, formes et intensités lumineuses, peuvent être utilisés à l'intérieur comme à l'extérieur, conviennent à différentes applications et environnements
- > **EFFICACITÉ ÉNERGÉTIQUE** - nos modèles sont pour la plupart de classe EEI C, consomment moins d'énergie et réduisent les coûts d'exploitation tout en produisant beaucoup de lumens
- > **FACILITÉ D'INSTALLATION ET D'ENTRETIEN** - installation simple avec un minimum d'entretien, entretien et nettoyage rapides et faciles
- > **PLATINES ET LAMPES INTERCHANGEABLES** - la série Basic est livrée avec des tubes LED interchangeables, toutes les autres séries sont équipées d'une platine LED intégrée

OVERVIEW

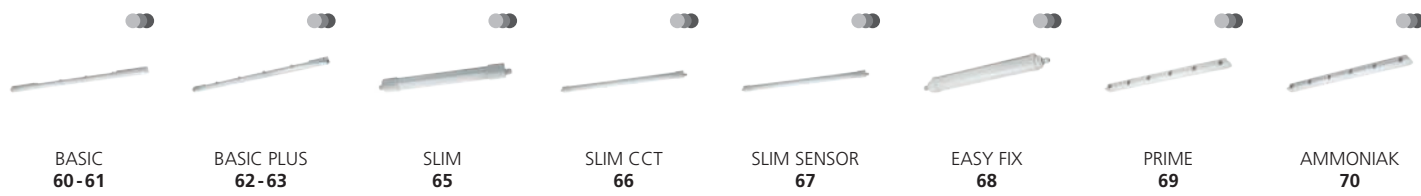

This product is available in different colors and shapes./ Dieser Artikel ist in unterschiedlichen Farben und Formen verfügbar./
Cet article est disponible en différentes couleurs et formes.



901541



901542



901543



901541 BASIC

tri proof lamp; plastic, grey / plastic, transparent
Feuchtraumleuchte; Kunststoff, grau / Kunststoff, transparent
Réglette étanche; plastique, gris / plastique, transparent

L 1260, B 73, H 56



901542 BASIC

tri proof lamp; plastic, grey / plastic, transparent
Feuchtraumleuchte; Kunststoff, grau / Kunststoff, transparent
Réglette étanche; plastique, gris / plastique, transparent

L 1260, B 99, H 56



901543 BASIC

tri proof lamp; plastic, grey / plastic, transparent
Feuchtraumleuchte; Kunststoff, grau / Kunststoff, transparent
Réglette étanche; plastique, gris / plastique, transparent

L 1560, B 73, H 56

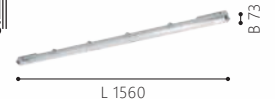
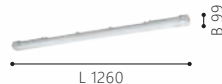
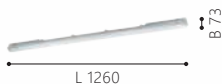



901544

LED



901544 BASIC

tri proof lamp; plastic, grey / plastic, transparent
 Feuchtraumleuchte; Kunststoff, grau / Kunststoff, transparent
 Réglette étanche; plastique, gris / plastique, transparent

L 1560, B 99, H 56



G13



2x 23 W



neutral
 WHITE
 2x
 2600lm



IP65





901545



901546



MECHANICAL PROTECTION
STOSSFESTIGKEIT
RÉSISTANCE AUX CHOCS

IK06



901547



901545 BASIC PLUS

tri proof lamp; plastic, grey / plastic, transparent
Feuchtraumleuchte; Kunststoff, grau / Kunststoff, transparent
Réglette étanche; plastique, gris / plastique, transparent

L 650, B 73, H 56



901546 BASIC PLUS

tri proof lamp; plastic, grey / plastic, transparent
Feuchtraumleuchte; Kunststoff, grau / Kunststoff, transparent
Réglette étanche; plastique, gris / plastique, transparent

L 1260, B 73, H 56



901547 BASIC PLUS

tri proof lamp; plastic, grey / plastic, transparent
Feuchtraumleuchte; Kunststoff, grau / Kunststoff, transparent
Réglette étanche; plastique, gris / plastique, transparent

L 1260, B 99, H 56

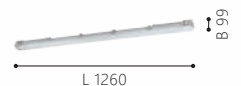
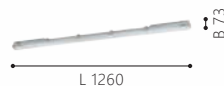
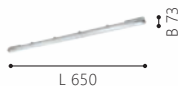
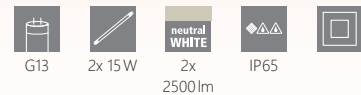



BASIC PLUS

- › INOX Clips
- › Metal reflector
- › High lumen tubes EEI C

- › INOX-Clips
- › Metallreflektor
- › Hochlumenröhren EEI C

- › INOX Clips
- › Réflecteur métallique
- › Tubes à haute luminosité EEI C



901548



901549



901548 BASIC PLUS

tri proof lamp; plastic, grey / plastic, transparent
 Feuchtraumleuchte; Kunststoff, grau / Kunststoff, transparent
 Réglette étanche; plastique, gris / plastique, transparent

L 1560, B 73, H 56



901549 BASIC PLUS

tri proof lamp; plastic, grey / plastic, transparent
 Feuchtraumleuchte; Kunststoff, grau / Kunststoff, transparent
 Réglette étanche; plastique, gris / plastique, transparent

L 1560, B 99, H 56



9 008606 313358

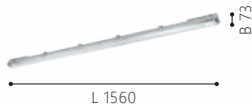

9 008606 313365







901551 SLIM

tri proof lamp; plastic, white / plastic, white
 Feuchtraumleuchte; Kunststoff, weiss / Kunststoff, weiss
 Réglette étanche; plastique, blanc / plastique, blanc

L 595, B 56, H 53



901552 SLIM

tri proof lamp; plastic, white / plastic, white
 Feuchtraumleuchte; Kunststoff, weiss / Kunststoff, weiss
 Réglette étanche; plastique, blanc / plastique, blanc

L 1105, B 56, H 53



901553 SLIM

tri proof lamp; plastic, white / plastic, white
 Feuchtraumleuchte; Kunststoff, weiss / Kunststoff, weiss
 Réglette étanche; plastique, blanc / plastique, blanc

L 1495, B 56, H 53

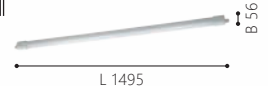
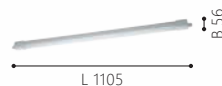



901554



901555



901554 SLIM CCT

tri proof lamp; plastic, white / plastic, white
 Feuchtraumleuchte; Kunststoff, weiss / Kunststoff, weiss
 Réglette étanche; plastique, blanc / plastique, blanc

L 1105, B 56, H 53



32W

5600lm

IP65



9 008606 313402



901555 SLIM CCT

tri proof lamp; plastic, white / plastic, white
 Feuchtraumleuchte; Kunststoff, weiss / Kunststoff, weiss
 Réglette étanche; plastique, blanc / plastique, blanc

L 1495, B 56, H 53



48W

7700lm

IP65



9 008606 313419





901556



IP65



901557



IP65

901556 SLIM SENSOR

tri proof lamp; plastic, white / plastic, white
 Feuchtraumleuchte; Kunststoff, weiss / Kunststoff, weiss
 Réglette étanche; plastique, blanc / plastique, blanc

L 1105, B 56, H 53



32 W



5600 lm



IP65



9 008606 313426



901557 SLIM SENSOR

tri proof lamp; plastic, white / plastic, white
 Feuchtraumleuchte; Kunststoff, weiss / Kunststoff, weiss
 Réglette étanche; plastique, blanc / plastique, blanc

L 1495, B 56, H 53



48 W



8500 lm



IP65



9 008606 313433

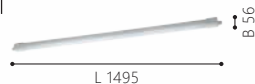



901558



EASY FIX

- > tool free installation
- > 3 pole connector
- > mounting in series
- > IK10 - ultra robust
- > werkzeuglose Montage
- > 3-poliger Steckverbinder
- > Montage in Reihe
- > IK10 - extrem robust
- > Installation sans outil
- > Connecteur 3 pôles
- > Montage en série
- > IK10 - ultra robuste



901559



901561



901558 EASY FIX

tri proof lamp; plastic, grey / plastic, white
 Feuchtraumleuchte; Kunststoff, grau / Kunststoff, weiss
 Réglette étanche; plastique, gris / plastique, blanc

L 600, B 67, H 72



901559 EASY FIX

tri proof lamp; plastic, grey / plastic, white
 Feuchtraumleuchte; Kunststoff, grau / Kunststoff, weiss
 Réglette étanche; plastique, gris / plastique, blanc

L 1090, B 67, H 72



901561 EASY FIX

tri proof lamp; plastic, grey / plastic, white
 Feuchtraumleuchte; Kunststoff, grau / Kunststoff, weiss
 Réglette étanche; plastique, gris / plastique, blanc

L 1490, B 67, H 72



9 008606 313440



9 008606 313457

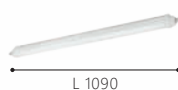

9 008606 313464





PRIME

- > tool free installation
- > wired through 5 pole in line and series mountable
- > additional central feeder
- > werkzeuglose Montage
- > 5-polig verdrahtet in Reihe und Serie montierbar
- > zusätzliche Zentraleinspeisung
- > installation sans outil
- > câblage par 5 pôles en ligne et montage en série
- > alimentation centrale supplémentaire



901562



IP65



901563



IP65



901562 PRIME

tri proof lamp; plastic, grey / plastic, white
 Feuchtraumleuchte; Kunststoff, grau / Kunststoff, weiss
 Réglette étanche; plastique, gris / plastique, blanc

L 1190, B 85, H 80



27W



4400lm



IP65

901563 PRIME

tri proof lamp; plastic, grey / plastic, white
 Feuchtraumleuchte; Kunststoff, grau / Kunststoff, weiss
 Réglette étanche; plastique, gris / plastique, blanc

L 1490, B 85, H 80



42W



6750lm



IP65



9 008606 313471



L 1190



9 008606 313488



L 1490



901564



901565



901537

AMMONIAK

- › ammoniak resistant materials
- › suitable for high pressure water jets and hot water
- › ideal for animal farming and car washes
- › wired through 5 pole in line and series mountable
- › ammoniakresistente Materialien
- › geeignet für Hochdruck- und Heißwasserstrahlen
- › ideal für Tierhaltung und Autowäsche
- › 5-polig verdrahtet in Reihe und Serie montierbar
- › matériaux résistants à l'ammoniac
- › convient aux jets d'eau à haute pression et à l'eau chaude
- › idéal pour l'élevage et le lavage de voitures
- › câblage par 5 pôles en ligne et montage en série

901564 AMMONIAK

tri proof lamp; plastic, grey / plastic, white
 Feuchtraumleuchte; Kunststoff, grau / Kunststoff, weiss
 Réglette étanche; plastique, gris / plastique, blanc

L 1190, B 85, H 80



9 008606 313495



901565 AMMONIAK

tri proof lamp; plastic, grey / plastic, white
 Feuchtraumleuchte; Kunststoff, grau / Kunststoff, weiss
 Réglette étanche; plastique, gris / plastique, blanc

L 1490, B 85, H 80



9 008606 313501



901537 SUSPENSION

accessory; steel, silver
 Zubehör; Stahl, silber
 Accessoires; acier, argent

H 1500



9 008606 313259

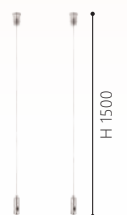





EGLO EXPERT

UNDERCABINET LUMINAIRES

ADVANTAGES

- > **POPULAR LIGHTING OPTION** - for wardrobes, cupboards, kitchens, bedrooms (reading area), caravans etc.
- > **DIRECT LIGHTING OF WORK SURFACES** - a well-lit environment makes working in the kitchen easier and improves visibility by installing under wall units and direct lighting on work surfaces
- > **IMPROVED VISIBILITY** - more precise performance of cooking activities and prevention of accidents thanks to better visibility of food, cooking utensils and tools with the help of targeted lighting of work areas
- > **AMBIENCE AND MOOD LIGHTING** - various lighting options, including dimmable LEDs and colour-changing options, create a pleasant atmosphere in rooms and adapt the lighting to the mood as required
- > **SPACE** - saving design - by mounting directly under the wall units, no additional space is taken up, ensuring a clean and tidy aesthetic in the kitchen

VORTEILE

- > **BELIEBTE BELEUCHTUNGSOPTION** - für Garderoben, Schränke, Küchen, Schlafzimmer (Lesebereich), Wohnwägen etc.
- > **DIREKTE BELEUCHTUNG VON ARBEITSFLÄCHEN** - gut beleuchtete Umgebung erleichtert das Arbeiten in der Küche und verbessert die Sicht durch die Installation unter Hängeschränken und direkter Beleuchtung auf Arbeitsflächen
- > **VERBESSERTE SICHTBARKEIT** - präzisere Durchführung von Kochaktivitäten und Vermeidung von Unfällen durch bessere Sicht auf Lebensmittel, Kochutensilien und Arbeitsgeräten mithilfe gezielter Beleuchtung von Arbeitsbereichen
- > **AMBIENTE UND STIMMUNGSBELEUCHTUNG** - verschiedene Beleuchtungsoptionen, einschließlich dimmbarer LEDs und Farbwechsellmöglichkeiten, schaffen eine angenehme Atmosphäre in Räumlichkeiten und passen das Beleuchten der Stimmung nach Bedarf an
- > **PLATZSPARENDES DESIGN** - durch Montage direkt unter den Hängeschränken wird kein zusätzlicher Platz in beansprucht, sorgt für saubere und ordentliche Ästhetik in der Küche

AVANTAGES

- > **OPTION D'ÉCLAIRAGE POPULAIRE** - pour les penderies, les armoires, les cuisines, les chambres (zone de lecture), les caravanes, etc.
- > **ÉCLAIRAGE DIRECT DES PLANS DE TRAVAIL** - un environnement bien éclairé facilite le travail dans la cuisine et améliore la visibilité grâce à l'installation sous les armoires suspendues et à l'éclairage direct des plans de travail
- > **AMÉLIORATION DE LA VISIBILITÉ** - les activités culinaires sont plus précises et les accidents sont évités grâce à une meilleure visibilité des aliments, des ustensiles de cuisine et des outils de travail grâce à un éclairage ciblé des zones de travail
- > **AMBIANCE ET ÉCLAIRAGE D'AMBIANCE** - différentes options d'éclairage, y compris des LED à intensité variable et des possibilités de changement de couleur, créent une atmosphère agréable dans les locaux et adaptent l'éclairage à l'ambiance selon les besoins
- > **DESIGN PEU ENCOMBRANT** - le montage directement sous les armoires suspendues n'occupe pas d'espace supplémentaire et garantit une esthétique propre et ordonnée dans la cuisine

OVERVIEW



This product is available in different colors and shapes./ Dieser Artikel ist in unterschiedlichen Farben und Formen verfügbar./
Cet article est disponible en différentes couleurs et formes.



901566



901567



901568



901566 MATTANZA

wall/ceiling light; plastic, white / plastic, white
Wand- / Deckenleuchte; Kunststoff, weiss / Kunststoff, weiss
Applique/Plafonnier; plastique, blanc / plastique, blanc

L 580, B 30, H 40



9W 1050lm



9 008606 313518

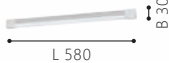

901567 MATTANZA

wall/ceiling light; plastic, white / plastic, white
Wand- / Deckenleuchte; Kunststoff, weiss / Kunststoff, weiss
Applique/Plafonnier; plastique, blanc / plastique, blanc

L 1180, B 30, H 40



24W 2100lm



9 008606 313525



901568 MATTANZA

wall/ceiling light; plastic, white / plastic, white
Wand- / Deckenleuchte; Kunststoff, weiss / Kunststoff, weiss
Applique/Plafonnier; plastique, blanc / plastique, blanc

L 1480, B 30, H 40



36W 2800lm



9 008606 313532





901569



901571



901569 SICCIAROTTA

wall/ceiling light; plastic, white / plastic, white
 Wand- / Deckenleuchte; Kunststoff, weiss / Kunststoff, weiss
 Applique/Plafonnier; plastique, blanc / plastique, blanc

L 600, B 75, H 25



18W 1800lm

901571 SICCIAROTTA

wall/ceiling light; plastic, white / plastic, white
 Wand- / Deckenleuchte; Kunststoff, weiss / Kunststoff, weiss
 Applique/Plafonnier; plastique, blanc / plastique, blanc

L 1245, B 75, H 25



36W 3600lm



9 008606 313549



9 008606 313556





EGLO EXPERT

WALL & CEILING LUMINAIRES

ADVANTAGES

- > **SUITABLE CHOICE FOR VARIOUS ENVIRONMENTS** - IP54 protection rating makes it particularly suitable for outdoor areas or damp rooms (e.g. raw concrete use)
- > **PROTECTION AGAINST DUST** - the first digit in the IP protection class stands for protection against foreign bodies such as dust, IP54 wall lights offer sufficient protection against the ingress of dust particles, increasing their durability and reliability
- > **PROTECTION AGAINST SPLASHING WATER** - second digit in the IP protection class indicates the degree of protection against water, IP54 wall lights offer protection against splashing water from all directions, ideal for use in humid environments such as bathrooms, kitchens or outdoor areas where they may be exposed to rain
- > **ROBUST DESIGN** - IP54 EGLO Expert wall luminaires are robustly built and can withstand the rigours of the environment, housing made from weather resistant materials resists corrosion and wear and tear
- > **VERSATILE APPLICATIONS** - UV-resistant, dust and splash water protection makes them suitable for a wide range of applications, both indoors and outdoors, e.g. corridors, stairwells, gardens, terraces, balconies and garages

VORTEILE

- > **GEEIGNETE WAHL FÜR VERSCHIEDENE UMGEBUNGEN** - durch Schutzgrad IP54 besonders für Außenbereiche oder Feuchträume (z.B. Rohbetoneinsatz) geeignet
- > **SCHUTZ VOR STAUB** - erste Ziffer in der IP-Schutzklasse steht für den Schutz vor Fremdkörpern wie Staub, IP54 Wandleuchten bieten ausreichenden Schutz vor Eindringen von Staubpartikeln, erhöht ihre Haltbarkeit und Zuverlässigkeit
- > **SCHUTZ VOR SPRITZWASSER** - zweite Ziffer in der IP-Schutzklasse gibt den Schutzgrad gegen Wasser an, IP54 Wandleuchten bieten Schutz gegen Spritzwasser aus allen Richtungen, ideal für den Einsatz in feuchten Umgebungen wie Badezimmern, Küchen oder Außenbereichen, wo sie Regen ausgesetzt sein können
- > **ROBUSTES DESIGN** - IP54 EGLO Expert Wandleuchten sind robust gebaut und können den Belastungen der Umgebung standhalten, Gehäuse aus wetterbeständigen Materialien widersteht Korrosion und Verschleiß
- > **VIELSEITIGE ANWENDUNGSMÖGLICHKEITEN** - UV-beständig, durch Schutz gegen Staub und Spritzwasser geeignet für eine Vielzahl von Anwendungen, sowohl im Innen- als auch im Außenbereich, z. B. Flure, Treppenhäuser, Gärten, Terrassen, Balkone und Garagen

AVANTAGES

- > **CHOIX ADAPTÉ À DIFFÉRENTS ENVIRONNEMENTS** - grâce à l'indice de protection IP54, elles sont particulièrement adaptées aux espaces extérieurs ou humides (par ex. utilisation de béton brut).
- > **PROTECTION CONTRE LA POUSSIÈRE** - le premier chiffre de la classe de protection IP indique la protection contre les corps étrangers comme la poussière, les appliques murales IP54 offrent une protection suffisante contre la pénétration de particules de poussière, ce qui augmente leur durabilité et leur fiabilité.
- > **PROTECTION CONTRE LES PROJECTIONS D'EAU** - le deuxième chiffre de la classe IP indique le degré de protection contre l'eau, les appliques murales IP54 offrent une protection contre les projections d'eau de toutes les directions, idéales pour une utilisation dans des environnements humides comme les salles de bains, les cuisines ou les espaces extérieurs où elles peuvent être exposées à la pluie.
- > **DESIGN ROBUSTE** - les appliques EGLO Expert IP54 sont de construction robuste et peuvent résister aux contraintes de l'environnement, le boîtier en matériaux résistants aux intempéries résiste à la corrosion et à l'usure
- > **APPLICATIONS MULTIPLES** - résistantes aux UV, adaptées à une multitude d'applications intérieures et extérieures grâce à une protection contre la poussière et les projections d'eau, par ex. couloirs, cages d'escalier, jardins, terrasses, balcons et garages

OVERVIEW



This product is available in different colors and shapes./ Dieser Artikel ist in unterschiedlichen Farben und Formen verfügbar./
Cet article est disponible en différentes couleurs et formes.



901524



IP54



901525



IP54



901527



360°, 5-10 m
5 sec.-3 min.



IP54

901524 APPRODO

wall/ceiling light; steel, white / plastic, white
Wand- / Deckenleuchte; Stahl, weiss / Kunststoff, weiss
Applique/Plafonnier; acier, blanc / plastique, blanc

H 55, Ø 260



12 W



1750 lm



IP54



9 008606 313143



Ø 260

901525 APPRODO

wall/ceiling light; steel, white / plastic, white
Wand- / Deckenleuchte; Stahl, weiss / Kunststoff, weiss
Applique/Plafonnier; acier, blanc / plastique, blanc

H 55, Ø 310



18 W



2250 lm



IP54



9 008606 313150



Ø 310

901527 APPRODO

wall/ceiling light; steel, white / plastic, white
Wand- / Deckenleuchte; Stahl, weiss / Kunststoff, weiss
Applique/Plafonnier; acier, blanc / plastique, blanc

H 55, Ø 310



18 W



2250 lm



IP54



9 008606 313174



Ø 310



901526



901529



901528



901526 APPRODO

wall/ceiling light; steel, white / plastic, white
Wand- / Deckenleuchte; Stahl, weiss / Kunststoff, weiss
Applique/Plafonnier; acier, blanc / plastique, blanc

H 70, Ø 430



36W



4600lm



IP54

901529 MARGIDORE

wall/ceiling light; steel, white / plastic, white, black
Wand- / Deckenleuchte; Stahl, weiss / Kunststoff, weiss, schwarz
Applique/Plafonnier; acier, blanc / plastique, blanc, noir

H 65, Ø 340



18W



2250lm



IP54

901528 MARGIDORE

wall/ceiling light; steel, white / plastic, white, satin nickel
Wand- / Deckenleuchte; Stahl, weiss / Kunststoff, weiss, nickel-
matt
Applique/Plafonnier; acier, blanc / plastique, blanc, nickel mat

H 65, Ø 340



18W



2250lm



IP54



9 008606 313167

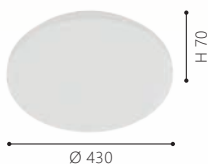

9 008606 313198



9 008606 313181

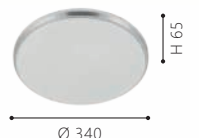



901577



IP54



901576



IP54

901576 MINERARIO

ceiling light; plastic, white / plastic, white
 Deckenleuchte; Kunststoff, weiss / Kunststoff, weiss
 plafonnier; plastique, blanc / plastique, blanc

H 30, Ø 300



14,4W



1800lm



IP54



9 008606 313600





901572



901577



901573



901572 MINERARIO

ceiling light; plastic, black / plastic, white
Deckenleuchte; Kunststoff, schwarz / Kunststoff, weiss
plafonnier; plastique, noir / plastique, blanc

H 30, Ø 300



901577 MINERARIO

ceiling light; plastic, white / plastic, white
Deckenleuchte; Kunststoff, weiss / Kunststoff, weiss
plafonnier; plastique, blanc / plastique, blanc

H 30, Ø 390



901573 MINERARIO

ceiling light; plastic, black / plastic, white
Deckenleuchte; Kunststoff, schwarz / Kunststoff, weiss
plafonnier; plastique, noir / plastique, blanc

H 30, Ø 390



9 008606 313563



9 008606 313617



9 008606 313570





901574



901578



901574



901578 MINERARIO

ceiling light; plastic, white / plastic, white
 Deckenleuchte; Kunststoff, weiss / Kunststoff, weiss
 plafonnier; plastique, blanc / plastique, blanc

L 290, B 290, H 30



14,4W



2000lm



IP54



901574 MINERARIO

ceiling light; plastic, black / plastic, white
 Deckenleuchte; Kunststoff, schwarz / Kunststoff, weiss
 plafonnier; plastique, noir / plastique, blanc

L 290, B 290, H 30



14,4W



2000lm



IP54



9 008606 313624

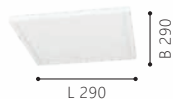

9 008606 313587





901579



901575



901579 MINERARIO

ceiling light; plastic, white / plastic, white
 Deckenleuchte; Kunststoff, weiss / Kunststoff, weiss
 plafonnier; plastique, blanc / plastique, blanc

L 390, B 390, H 30



901575 MINERARIO

ceiling light; plastic, black / plastic, white
 Deckenleuchte; Kunststoff, schwarz / Kunststoff, weiss
 plafonnier; plastique, noir / plastique, blanc

L 390, B 390, H 30



9 008606 313631



9 008606 313594

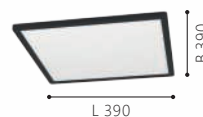



EGLO EXPERT TUBES

ADVANTAGES

- > **RANGE OF ADVANTAGES** - compared to conventional fluorescent tubes
- > **ENERGY EFFICIENCY** - consume up to 50-60% less electricity than conventional fluorescent tubes, resulting in significant savings in energy costs
- > **LONGER LIFE** - much longer life compared to fluorescent tubes, reducing the need for frequent replacements and reducing maintenance costs
- > **LOWER HEAT GENERATION** - lower heat generation than fluorescent tubes increases efficiency and reduces susceptibility to overheating
- > **NO FLICKERING** - instant and constant illumination without flickering, unlike fluorescent tubes which can flicker and require a warm-up time to reach brightness
- > **NO QUECKSILVER** - LED tubes contain no mercury - unlike old fluorescent tubes, making disposal easier
- > **FLEXIBILITY OF USE** - due to the different sizes, color temperatures and light intensities, it is suitable for a variety of luminaires, can be easily installed in existing fluorescent tube sockets using the included LED Starter, enable simple and cost-effective conversion, an energy-efficient, long-lasting, environmentally friendly and versatile lighting solution
- > **ONLY FOR KVG LUMINAIRES** - only to be used with conventional ballasts

VORTEILE

- > **REIHE VON VORTEILEN** - gegenüber herkömmlichen Leuchtstoffröhren
- > **ENERGIEEFFIZIENZ** - verbrauchen bis zu 50-60% weniger Strom als konventionelle Leuchtstoffröhren, führt zu erheblichen Einsparungen bei den Energiekosten
- > **LÄNGERE LEBENSDAUER** - viel längere Lebensdauer im Vergleich zu Leuchtstoffröhren, reduziert die Notwendigkeit häufiger Austausche und verringert Wartungskosten
- > **GERINGERE WÄRMEENTWICKLUNG** - geringere Wärmeentwicklung als bei Leuchtstoffröhren steigert die Effizienz und mindert die Anfälligkeit für Überhitzung
- > **KEIN FLACKERN** - sofortige und konstante Beleuchtung ohne Flackern, anders als Leuchtstoffröhren, die flackern können und eine Aufwärmzeit benötigen um ihre Helligkeit zu erreichen
- > **KEIN QUECKSILBER** - LED Röhren enthalten kein Quecksilber - anders als alte Leuchtstoffröhren, erleichtert die Entsorgung
- > **FLEXIBILITÄT IN DER ANWENDUNG** - aufgrund der verschiedenen Größen, Farbtemperaturen und Lichtstärken für eine Vielzahl an Leuchten geeignet, können mithilfe des beigegepackten LED Starters problemlos in bestehende Leuchtstoffröhren-Fassungen installiert werden, ermöglichen einfache und kostengünstige Umstellung, eine energieeffiziente, langlebige, umweltfreundliche und vielseitige Beleuchtungslösung
- > **NUR FÜR KVG LEUCHTEN** - nur für konventionelle Vorschaltgeräte zu verwenden

AVANTAGES

- > **UNE SÉRIE D'AVANTAGES** - par rapport aux tubes fluorescents conventionnels
- > **EFFICACITÉ ÉNERGÉTIQUE** - consomment jusqu'à 50-60% d'électricité en moins que les tubes fluorescents conventionnels, ce qui permet de réaliser des économies d'énergie substantielles.
- > **DURÉE DE VIE PLUS LONGUE** - durée de vie beaucoup plus longue que celle des tubes fluorescents, réduit la nécessité de remplacements fréquents et diminue les coûts de maintenance.
- > **MOINS DE CHALEUR** - la chaleur générée est inférieure à celle des tubes fluorescents, ce qui augmente l'efficacité et réduit le risque de surchauffe
- > **PAS DE SCINTILLEMENT** - éclairage instantané et constant sans scintillement, contrairement aux tubes fluorescents qui peuvent scintiller et nécessitent un temps de préchauffage pour atteindre leur luminosité.
- > **PAS DE MERCURE** - Les tubes LED ne contiennent pas de mercure, contrairement aux anciens tubes fluorescents, ce qui facilite leur élimination
- > **FLEXIBILITÉ D'APPLICATION** - convient à une grande variété de luminaires grâce aux différentes tailles, températures de couleur et intensités lumineuses, s'installe facilement dans les douilles de tubes fluorescents existantes à l'aide du starter LED fourni, permet une conversion simple et économique, une solution d'éclairage efficace en énergie, durable, écologique et polyvalente
- > **UNIQUEMENT POUR LES LUMINAIRES À BALLAST ÉLECTRONIQUE** - à utiliser uniquement avec des ballasts conventionnels

OVERVIEW



LM_LED_G13
86-91



This product is available in different colors and shapes./ Dieser Artikel ist in unterschiedlichen Farben und Formen verfügbar./
Cet article est disponible en différentes couleurs et formes.

110339 G13-LED-T8-TUBE



1650 lm

neutral
WHITE

4000 K



L 590, Ø 28



not dimmable



10 W



10



220-240V, 50/60Hz



G13



9 008606 313068

110341 G13-LED-T8-TUBE



2500 lm

neutral
WHITE

4000 K



L 1214, Ø 28



not dimmable



15 W



10



220-240V, 50/60Hz



G13



9 008606 313075

110342 G13-LED-T8-TUBE



3700 lm

neutral
WHITE

4000 K



L 1514, Ø 28



not dimmable



23 W



10



220-240V, 50/60Hz



G13



9 008606 313082

110347 G13-LED-T8-TUBE



| | | | |
|----------------|----------------------|---------------|----------|
| 2400 lm | neutral WHITE | 4000 K | A |
| L 1214, Ø 28 | not dimmable | 10 | |
| 15 W | 220-240V, 50/60Hz | Motion Sensor | |
| G13 | | | |



110348 G13-LED-T8-TUBE



| | | | |
|----------------|----------------------|---------------|----------|
| 3700 lm | neutral WHITE | 4000 K | A |
| L 1514, Ø 28 | not dimmable | 10 | |
| 23 W | 220-240V, 50/60Hz | Motion Sensor | |
| G13 | | | |



G13-LED-T8-TUBE

Shatterproof – These articles are encased in a plastic cover and therefore break-resistant.









Bruchhemmend – Diese Artikel sind mit einer Kunststoffhülle umgeben und dadurch bruchhemmend.

Résistants à la rupture - Ces articles sont enveloppés d'une housse en plastique et sont donc résistants à la casse.



110337 G13-LED-T8-TUBE











| | | |
|---|---|---|
|  1700 lm | warm WHITE 3000 K |  |
|  L 1214, Ø 28 |  not dimmable | |
|  15 W |  10 | |
|  220-240V, 50/60Hz | | |
|  G13 | | |



110338 G13-LED-T8-TUBE



| | | |
|---|---|---|
|  2600 lm | warm WHITE 3000 K |  |
|  L 1514, Ø 28 |  not dimmable | |
|  23 W |  10 | |
|  220-240V, 50/60Hz | | |
|  G13 | | |



110349 G13-LED-T8-TUBE



1100 lm

neutral
WHITE

4000 K



L 590, Ø 28



not dimmable



10 W



220-240V, 50/60Hz



G13



9 008606 325894

110343 G13-LED-T8-TUBE



1700 lm

neutral
WHITE

4000 K



L 1214, Ø 28



not dimmable



15 W



10



220-240V, 50/60Hz



G13



9 008606 313006

110344 G13-LED-T8-TUBE



2600 lm

neutral
WHITE

4000 K



L 1514, Ø 28



not dimmable



23 W



10



220-240V, 50/60Hz











G13



9 008606 313013

110345 G13-LED-T8-TUBE











| | | |
|---|---|---|
|  1700 lm | cold WHITE 6500 K |  |
|  L 1214, Ø 28 |  not dimmable | |
|  15 W |  10 | |
|  220-240V, 50/60Hz | | |
|  G13 | | |



110346 G13-LED-T8-TUBE



| | | |
|---|---|---|
|  2600 lm | cold WHITE 6500 K |  |
|  L 1514, Ø 28 |  not dimmable | |
|  23 W |  10 | |
|  220-240V, 50/60Hz | | |
|  G13 | | |





KITCHEN & FUNCTIONAL LUMINAIRES

ADVANTAGES

- > PERFECT ADDITION TO THE KITCHEN AREA AND OPTIMUM LIGHTING OPTION
 - > CREATE IDEAL LIGHTING CONDITIONS FOR VARIOUS KITCHEN ACTIVITIES
 - > ENSURE OPTIMUM ILLUMINATION OF WORK SURFACES AND THUS BECOME AN EVERYDAY AID
 - > UNDER-CABINET LUMINAIRES CREATE A PLEASANT ATMOSPHERE IN THE LIVING AREA
-

VORTEILE

- > PERFEKTE ERGÄNZUNG FÜR DEN KÜCHENBEREICH UND OPTIMALE BELEUCHTUNGSMÖGLICHKEIT
 - > SCHAFFEN IDEALE LICHTVERHÄLTNISSE FÜR VERSCHIEDENE KÜCHENAKTIVITÄTEN
 - > SORGEN FÜR OPTIMALE AUSLEUCHTUNG VON ARBEITSFLÄCHEN UND WERDEN DADURCH ZUR ALLTAGSHILFE
 - > UNTERBAULEUCHTEN SORGEN FÜR EINE ANGENEHME ATMOSPHÄRE IM WOHNRAUM
-

AVANTAGES

- > COMPLÉMENT PARFAIT POUR L'ESPACE CUISINE ET POSSIBILITÉ D'ÉCLAIRAGE OPTIMALE
- > CRÉENT DES CONDITIONS D'ÉCLAIRAGE IDÉALES POUR DIFFÉRENTES ACTIVITÉS EN CUISINE
- > ASSURENT UN ÉCLAIRAGE OPTIMAL DES PLANS DE TRAVAIL ET DEVIENNENT AINSI UNE AIDE AU QUOTIDIEN
- > LES LUMINAIRES SOUS PLAN CRÉENT UNE ATMOSPHÈRE AGRÉABLE DANS LA PIÈCE À VIVRE

OVERVIEW



This product is available in different colors and shapes./ Dieser Artikel ist in unterschiedlichen Farben und Formen verfügbar./
Cet article est disponible en différentes couleurs et formes.

DESIGN
HIGHLIGHT
DETAIL



97572

LED



97573

LED



97574

LED

97572 DUNDRY

wall/ceiling light; plastic, white / plastic, white
Wand- / Deckenleuchte; Kunststoff, weiss / Kunststoff, weiss
Applique/Plafonnier; plastique, blanc / plastique, blanc

L 570, B 25, H 35



6,6W 850lm



9 002759 975722



97573 DUNDRY

wall/ceiling light; plastic, white / plastic, white
Wand- / Deckenleuchte; Kunststoff, weiss / Kunststoff, weiss
Applique/Plafonnier; plastique, blanc / plastique, blanc

L 870, B 25, H 35



9,3W 1250lm



9 002759 975739



97574 DUNDRY

wall/ceiling light; plastic, white / plastic, white
Wand- / Deckenleuchte; Kunststoff, weiss / Kunststoff, weiss
Applique/Plafonnier; plastique, blanc / plastique, blanc

L 1170, B 25, H 35



12,8W 1700lm



9 002759 975746





97571

LED



97571

LED

97571 DUNDRY

wall/ceiling light; plastic, white / plastic, white
 Wand- / Deckenleuchte; Kunststoff, weiss / Kunststoff, weiss
 Applique/Plafonnier; plastique, blanc / plastique, blanc

L 310, B 25, H 35

LED

3,7W

neutral
WHITE

450lm



9 002759 975715





96081

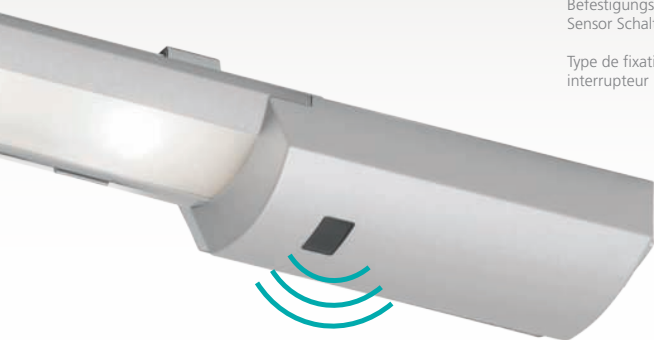

96081

Mounting type: incl. mounting clips, Switch type: sensor switch (on/off).

Befestigungsart: inkl. Montageclips, Schalterart: Sensor Schalter (ein/aus).

Type de fixation : clips de montage inclus, Type de interrupteur : interrupteur capteur (on/off).



96081



0,15m



93707



93706



96081 TEYA

under cabinet light; aluminium, silver / plastic, white
 Unterbauleuchte; Alu, silber / Kunststoff, weiss
 éclairage de meuble; aluminium, argent / plastique, blanc

L 600, B 55, H 25



10W



950lm



93707 KOB LED

under cabinet light; steel, satin nickel
 Unterbauleuchte; Stahl, nickel-matt
 éclairage de meuble; acier, nickel mat

L 600, B 70, H 25



3x 2,3W



840lm



93706 KOB LED

under cabinet light; steel, white
 Unterbauleuchte; Stahl, weiss
 éclairage de meuble; acier, blanc

L 600, B 70, H 25



3x 2,3W



840lm



9 002759 960810



L 600



9 002759 937072



L 600



9 002759 937065



L 600



TRACK SYSTEM

ADVANTAGES

- > **EASY TRACK** - DESIGNED TO ENHANCE ANY SPACE'S AMBIANCE AND FUNCTIONALITY, THIS NEW HIGH VOLTAGE TRACK SYSTEM OFFERS ACCESSIBLE AND PRACTICAL SOLUTION FOR YOUR HOME. A SIMPLE OFFER, UNLIMITED POSSIBILITIES, ATTRACTIVE PRICE AND ACCESSORIES FULLY INTEGRATED INTO THE METAL TRACK BRING NOVELTY TO THE TRACK MARKET.
 - > **TRACK PLUS** - THIS EXTRA-FLAT TRACK TAKES THE TRACK SYSTEM TO ANOTHER LEVEL. PERFECT FOR WALL AND CEILING MOUNTING, THIS TRACK CAN BE INTEGRATED ANYWHERE. SET THE CCT AND BRIGHTNESS LEVEL OF YOUR ACCESSORIES AS YOU LIKE WITH THE INCLUDED REMOTE CONTROL AND MANAGE YOUR PRODUCTS IN 2 DIFFERENT GROUPS FOR GREATER FLEXIBILITY.
-

VORTEILE

- > **EASY TRACK** - ENTWICKELT, UM DAS AMBIENTE UND DIE FUNKTIONALITÄT EINES JEDEN RAUMES ZU VERBESSERN, BIETET DIESES NEUE HOCHSPANNUNGSSCHIENENSYSTEM EINE ZUGÄNGLICHE UND PRAKTISCHE LÖSUNG FÜR IHR ZUHAUSE. EIN EINFACHES ANGEBOT, UNBEGRENZTE MÖGLICHKEITEN, EIN ATTRAKTIVER PREIS UND VOLLSTÄNDIG IN DIE METALLSCHIENE INTEGRIERTES ZUBEHÖR BRINGEN EINE NEUHEIT AUF DEN SCHIENENMARKT.
 - > **TRACK PLUS** - DIESE EXTRAFLACHE SCHIENE HEBT DAS SCHIENENSYSTEM AUF EINE NEUE EBENE. PERFEKT FÜR DIE WAND- UND DECKENMONTAGE, KANN DIESE SCHIENE ÜBERALL INTEGRIERT WERDEN. MIT DER MITGELIEFERTEN FERNBEDIENUNG KÖNNEN SIE DIE FARBTEMPERATUR UND DIE HELLIGKEIT IHRES ZUBEHÖRS NACH BELIEBEN EINSTELLEN UND IHRE PRODUKTE IN 2 VERSCHIEDENEN GRUPPEN VERWALTEN, UM MEHR FLEXIBILITÄT ZU ERREICHEN.
-

AVANTAGES

- > **EASY TRACK** - CONÇU POUR AMÉLIORER L'AMBIANCE ET LA FONCTIONNALITÉ DE TOUT ESPACE, CE NOUVEAU SYSTÈME DE RAIL HAUTE TENSION OFFRE UNE SOLUTION ACCESSIBLE ET PRATIQUE POUR VOTRE MAISON. UNE OFFRE SIMPLE, DES POSSIBILITÉS ILLIMITÉES, UN PRIX ATTRACTIF ET DES ACCESSOIRES ENTIÈREMENT INTÉGRÉS DANS LE RAIL MÉTALLIQUE APPORTENT DE LA NOUVEAUTÉ SUR LE MARCHÉ DES RAILS.
- > **TRACK PLUS** - CE RAIL EXTRA-PLAT FAIT PASSER LE SYSTÈME DE RAIL À UN AUTRE NIVEAU. PARFAIT POUR UN MONTAGE MURAL OU AU PLAFOND, CE RAIL PEUT ÊTRE INTÉGRÉ PARTOUT. RÉGLEZ LE CCT ET LE NIVEAU DE LUMINOSITÉ DE VOS ACCESSOIRES COMME VOUS LE SOUHAITEZ À L'AIDE DE LA TÉLÉCOMMANDE FOURNIE ET GÉREZ VOS PRODUITS DANS 2 GROUPES DIFFÉRENTS POUR UNE PLUS GRANDE FLEXIBILITÉ.





TRACK SYSTEM

EASY TRACK

ADVANTAGES

- > EASY CEILING AND PENDANT MOUNTING
- > FLEXIBLE USAGE WITH GU10
- > SEAMLESS DESIGN
- > ENTRY-LEVEL PRICE
- > SIMPLIFIED OFFER, EASY TO UNDERSTAND FOR END CONSUMER
- > EASY INSTALLATION
- > QUICK ASSEMBLY AND DISASSEMBLY OF ACCESSORIES FOR EASY MAINTENANCE AND CUSTOMIZATION

VORTEILE

- > EINFACHE DECKEN- UND PENDELMONTAGE
- > FLEXIBLER EINSATZ MIT GU10
- > NAHTLOSES DESIGN
- > EINSTIEGSPREIS
- > VEREINFACHTES, FÜR DEN ENDVERBRAUCHER LEICHT VERSTÄNDLICHES ANGEBOT
- > EINFACHE INSTALLATION
- > SCHNELLE MONTAGE UND DEMONTAGE DES ZUBEHÖRS FÜR EINFACHE WARTUNG UND ANPASSUNG

AVANTAGES

- > MONTAGE FACILE AU PLAFOND ET EN SUSPENSION
- > UTILISATION FLEXIBLE AVEC GU10
- > DESIGN HOMOGENÈME
- > PRIX D'ENTRÉE DE GAMME
- > OFFRE SIMPLIFIÉE, FACILE À COMPRENDRE POUR LE CONSOMMATEUR FINAL
- > INSTALLATION FACILE
- > MONTAGE ET DÉMONTAGE RAPIDES DES ACCESSOIRES POUR UNE MAINTENANCE ET UNE PERSONNALISATION AISÉES

OVERVIEW



EASYT SET 4
SPOTS
104, 110



EASYT SET 3
SPOTS
104, 110



EASYT TRACK
105, 111

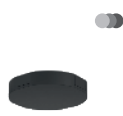

EASYT FEEDER
105, 111



EASYT SPOT TUBE
106, 112



EASYT SPOT RING
106, 112



EASYT PENDANT
106, 112



EASYT E27 ADAPTER
108, 114



EASYT CORNER
109, 115



EASYT CONNECTOR
109, 115



This product is available in different colors and shapes./ Dieser Artikel ist in unterschiedlichen Farben und Formen verfügbar./
Cet article est disponible en différentes couleurs et formes.

SEAMLESS INTEGRATION /
NAHTLOSE INTEGRATION /
INTÉGRATION TRANSPARENTE



Experience seamless design with integrated track spots. / Erleben Sie nahtloses Design mit in die Schiene integrierten Spots. / Découvrez une conception sans faille avec des spots de piste intégrés.



Customize your lighting experience by fitting your preferred GU10 bulb into our versatile models. With three light sources to choose from, you can create the perfect ambiance for your home. Rotate the spots to adjust the direction of light as desired. Use the E27 Adapter to extend your track with your preferred shade.

Passen Sie Ihr Lichtelebnis an, indem Sie Ihre bevorzugte GU10-Lampe in unsere vielseitigen Modelle einsetzen. Mit den drei zur Auswahl stehenden Lichtquellen können Sie das perfekte Ambiente für Ihr Zuhause schaffen. Drehen Sie die Spots, um die Lichtrichtung nach Wunsch einzustellen. Verwenden Sie den E27-Adapter, um Ihre Schiene mit Ihrem bevorzugten Lampenschirm zu erweitern.

Personnalisez votre expérience d'éclairage en installant l'ampoule GU10 de votre choix dans nos modèles polyvalents. Avec trois sources de lumière au choix, vous pouvez créer l'ambiance parfaite pour votre maison. Faites pivoter les spots pour ajuster la direction de la lumière comme vous le souhaitez. Utilisez l'adaptateur E27 pour prolonger votre rail avec l'abat-jour de votre choix.

FEW CONNECTORS, INFINITE POSSIBILITIES / WENIGE STECKVERBINDER, UNENDLICHE MÖGLICHKEITEN / PEU DE CONNECTEURS, DES POSSIBILITÉS INFINIES

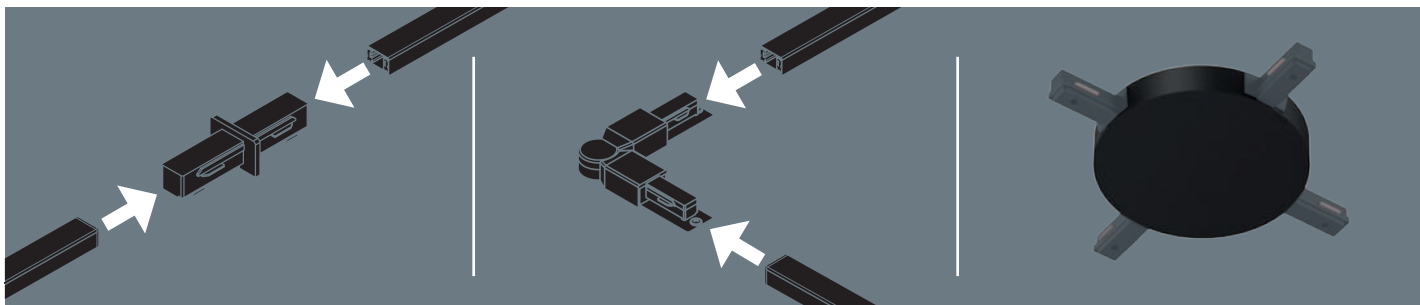

Utilize the basic straight connector to expand your track system.

Nutzen Sie den einfachen, geraden Verbinder, um Ihr Schienensystem zu erweitern.

Utilisez le connecteur droit de base pour étendre votre système de rails.

The corner connector not only creates an L-shaped connection but also accommodates angles ranging from 30 to 180 degrees.

Der Eckverbinder schafft nicht nur eine L-förmige Verbindung, sondern ermöglicht auch Winkel von 30 bis 180 Grad.

Le connecteur angulaire permet non seulement de créer une connexion en forme de L, mais aussi d'accommoder des angles allant de 30 à 180 degrés.

The versatile All-in-one Feeder functions as both a middle or side feeder and serves as a connector to create L, T or X connections.

Der vielseitige All-in-one Feeder fungiert sowohl als mittlerer oder seitlicher Einspeiser als auch als Verbinder, um L-, T- oder X-Verbindungen herzustellen.

L'alimentateur polyvalent Tout-en-un sert à la fois d'alimentateur central ou latéral et de connecteur pour créer des connexions en L, T ou en X.

MODULAR SOLUTION / MODULARE LÖSUNG / SOLUTION MODULAIRE



With our innovative track system, which can be extended as required, you can place the power outlet inconspicuously exactly where it is needed. This gives you a perfectly positioned lamp above the dining table. A cover is included for a seamless design.

Mit unserem innovativen, je nach Wunsch erweiterbaren Schienensystem bringst du den Stromauslass unauffällig genau dorthin, wo er gebraucht wird. So erhältst du eine perfekt platzierte Lampe über dem Esstisch. Eine mitgelieferte Abdeckung sorgt für ein nahtloses Design.

Grâce à notre système de rails innovant et extensible à souhait, tu peux placer la sortie de courant là où tu en as besoin, sans te faire remarquer. Tu obtiens ainsi une lampe parfaitement placée au-dessus de la table à manger. Un couvercle fourni assure un design sans faille.



901652



EASYT SET 4 SPOTS

Individually customizable.

Individuell anpassbar.

Personnalisable individuellement.



901653

901652 EASYT SET 4 SPOTS

system; aluminium, plastic, black / plastic, black
System; Alu, Kunststoff, schwarz / Kunststoff, schwarz
système; aluminium, plastique, noir / plastique, noir

L 1925, B 55, H 140



GU10



4x 35W



9 008606 323371

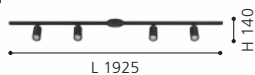

L 1925

H 140

901653 EASYT SET 3 SPOTS

system; aluminium, plastic, black / plastic, black
System; Alu, Kunststoff, schwarz / Kunststoff, schwarz
système; aluminium, plastique, noir / plastique, noir

L 1020, B 55, H 140



GU10



3x 35W



9 008606 323388

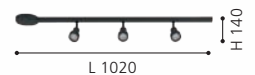

L 1020

H 140

EASYT TRACK

Connector to EASYT FEEDER included.

Verbinder an EASYT FEEDER inklusive.

Connecteur pour EASYT FEEDER inclus.



EASYT FEEDER

This adapter can be used with up to 4 outputs.

Dieser Adapter kann mit bis zu 4 Ausgängen verwendet werden.

Cet adaptateur peut être utilisé avec jusqu'à 4 sorties.



901638 EASYT TRACK

accessory; aluminium, black
Zubehör; Alu, schwarz
Accessoires; aluminium, noir

L 900, B 30, H 18

901639 EASYT FEEDER

accessory; plastic, black
Zubehör; Kunststoff, schwarz
Accessoires; plastique, noir

H 20, Ø 120

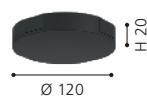
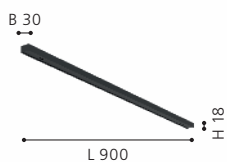



901647



901648



901651

EASYT PENDANT

You can easily shorten the cable of the EASYT PENDANT yourself.

Das Kabel der EASYT PENDANT Hängeleuchte kann einfach selbst gekürzt werden.

Le câble de la suspension EASYT PENDANT peut être facilement raccourci par l'utilisateur.

901647 EASYT SPOT TUBE

spot; plastic, black
Spot; Kunststoff, schwarz
spot; plastique, noir

L 120, H 140, Ø 55



GU10 1x 35W



9 008606 323401



901648 EASYT SPOT RING

spot; plastic, black
Spot; Kunststoff, schwarz
spot; plastique, noir

L 120, H 140, Ø 55



GU10 1x 35W



9 008606 323418



901651 EASYT PENDANT

pendant light; plastic, black
Hängeleuchte; Kunststoff, schwarz
luminaire en suspension; plastique, noir

L 120, H 1100, Ø 60



GU10 1x 35W



9 008606 323432





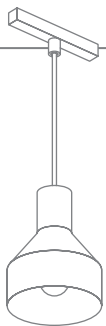

EASYT E27 ADAPTER

Use your own lights! With the EASYT E27 ADAPTER, almost any lampshade can be installed in the track system.

Verwenden Sie Ihre eigenen Leuchten! Mit dem EASYT E27 ADAPTER kann nahezu jeder Lampenschirm im Schienensystem verbaut werden.

Utilisez vos propres luminaires ! Avec EASYT E27 ADAPTER, il est possible d'installer pratiquement n'importe quel abat-jour dans le système de rails.



901644

901644 EASYT E27 ADAPTER

pendant light; plastic, black
Hängeleuchte; Kunststoff, schwarz
luminaire en suspension; plastique, noir

L 120, H 1000, Ø 58



E27



1x 40W



EASYT CORNER

With the EASYT Corner, rails can be connected at an angle of 45° - 180°.

Mit dem EASYT Corner können Schienen im Winkel von 45° - 180° verbunden werden.

L'EASYT Corner permet de relier des rails à un angle de 45° à 180°.

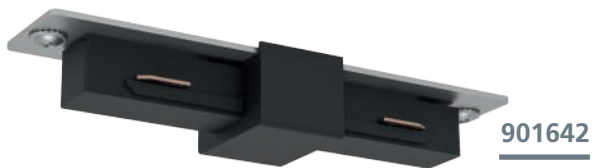

901641 EASYT CORNER

accessory; plastic, black
Zubehör; Kunststoff, schwarz
Accessoires; plastique, noir

L 187, B 30, H 18

901642 EASYT CONNECTOR

accessory; plastic, black
Zubehör; Kunststoff, schwarz
Accessoires; plastique, noir

L 74, B 30, H 18





901667



EASYT SET 4 SPOTS

Individually customizable.

Individuell anpassbar.

Personnalisable individuellement.



901668

901667 EASYT SET 4 SPOTS

system; aluminium, plastic, white / plastic, white
System; Alu, Kunststoff, weiss / Kunststoff, weiss
système; aluminium, plastique, blanc / plastique, blanc

L 1925, B 55, H 140



GU10



4x 35W



9 008606 323517

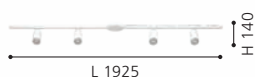

L 1925

901668 EASYT SET 3 SPOTS

system; aluminium, plastic, white / plastic, white
System; Alu, Kunststoff, weiss / Kunststoff, weiss
système; aluminium, plastique, blanc / plastique, blanc

L 1020, B 55, H 140



GU10



3x 35W



9 008606 323524

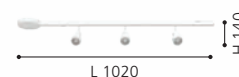

L 1020

EASYT TRACK

Connector to EASYT FEEDER included.

Verbinder an EASYT FEEDER inklusive.

Connecteur pour EASYT FEEDER inclus.



EASYT FEEDER

This adapter can be used with up to 4 outputs.

Dieser Adapter kann mit bis zu 4 Ausgängen verwendet werden.

Cet adaptateur peut être utilisé avec jusqu'à 4 sorties.



901654 EASYT TRACK

accessory; aluminium, white
Zubehör; Alu, weiss
Accessoires; aluminium, blanc

L 900, B 30, H 18

901655 EASYT FEEDER

accessory; plastic, white
Zubehör; Kunststoff, weiss
Accessoires; plastique, blanc

H 20, Ø 120

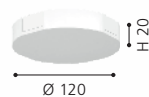
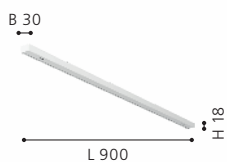



901663



901664



EASYT PENDANT

You can easily shorten the cable of the EASYT PENDANT yourself.

Das Kabel der EASYT PENDANT Hängeleuchte kann einfach selbst gekürzt werden.

Le câble de la suspension EASYT PENDANT peut être facilement raccourci par l'utilisateur.

901663 EASYT SPOT TUBE

spot; plastic, white
Spot; Kunststoff, weiss
spot; plastique, blanc

L 120, H 140, Ø 55



GU10 1x 35W



9 008606 323548



901664 EASYT SPOT RING

spot; plastic, white
Spot; Kunststoff, weiss
spot; plastique, blanc

L 120, H 140, Ø 55



GU10 1x 35W



9 008606 323555



901666 EASYT PENDANT

pendant light; plastic, white
Hängeleuchte; Kunststoff, weiss
luminaire en suspension; plastique, blanc

L 120, H 1100, Ø 60



GU10 1x 35W



9 008606 323579





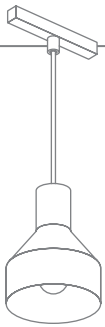

EASYT E27 ADAPTER

Use your own lights! With the EASYT E27 ADAPTER, almost any lampshade can be installed in the track system.

Verwenden Sie Ihre eigenen Leuchten! Mit dem EASYT E27 ADAPTER kann nahezu jeder Lampenschirm im Schienensystem verbaut werden.

Utilisez vos propres luminaires ! Avec EASYT E27 ADAPTER, il est possible d'installer pratiquement n'importe quel abat-jour dans le système de rails.



901659

901659 EASYT E27 ADAPTER

pendant light; plastic, white
Hängeleuchte; Kunststoff, weiss
luminaire en suspension; plastique, blanc

L 120, H 1000, Ø 58



E27



1x 40W



9 008606 323623



EASYT CORNER

With the EASYT Corner, rails can be connected at an angle of 45° - 180°.

Mit dem EASYT Corner können Schienen im Winkel von 45° - 180° verbunden werden.

L'EASYT Corner permet de relier des rails à un angle de 45° à 180°.

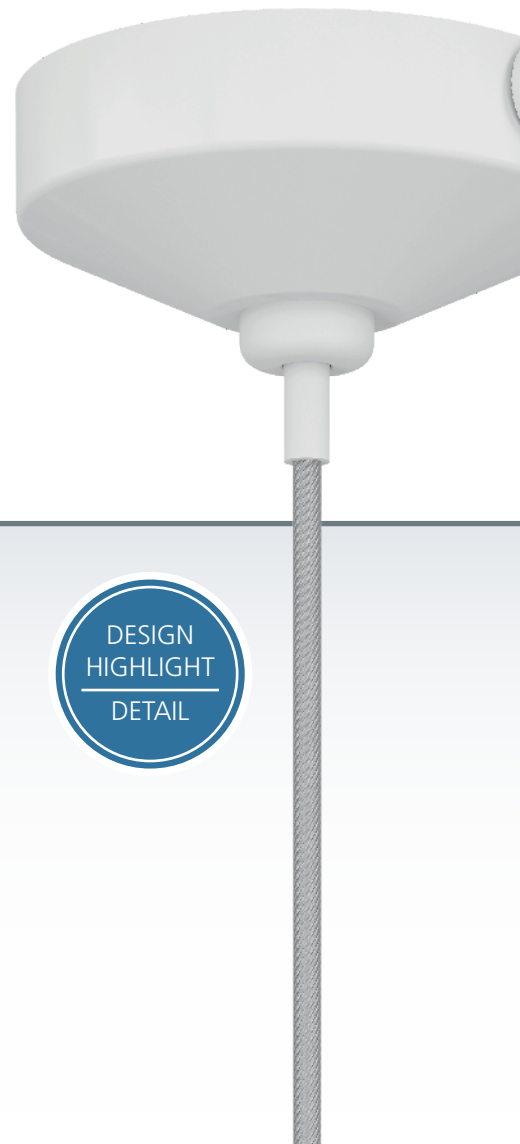

901656 EASYT CORNER

accessory; plastic, white
Zubehör; Kunststoff, weiss
Accessoires; plastique, blanc

L 187, B 30, H 18

901657 EASYT CONNECTOR

accessory; plastic, white
Zubehör; Kunststoff, weiss
Accessoires; plastique, blanc

L 74, B 30, H 18

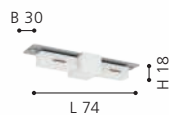
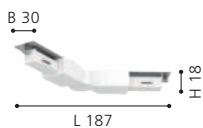



TRACK SYSTEM

TRACK PLUS

ADVANTAGES

- > EXTRA FLAT TRACK (6MM)
 - > WALL AND CEILING MOUNTING
 - > DIMMING AND CCT BY REMOTE
 - > CONTROLLABLE BY GROUP
 - > HIGH LUMEN OUTPUT
 - > MODERN AND INNOVATIVE LIGHTING SOLUTIONS
 - > ABILITY TO CONTROL BRIGHTNESS AND LIGHT COLOR FOR INDIVIDUAL ATMOSPHERES
-

VORTEILE

- > EXTRA FLACHE SCHIENE (6MM)
 - > WAND- UND DECKENMONTAGE
 - > DIMMEN UND STEUERUNG PER FERNBEDIENUNG
 - > GRUPPENWEISE STEUERBAR
 - > HOHER LUMENAUSSSTOSS
 - > MODERNE UND INNOVATIVE LICHTLÖSUNGEN
 - > STEUERUNG VON HELLIGKEIT UND LICHTFARBE FÜR INDIVIDUELLE ATMOSPHÄREN
-

AVANTAGES

- > RAIL EXTRA PLAT (6MM)
- > MONTAGE AU MUR ET AU PLAFOND
- > GRADATION ET CONTRÔLE PAR TÉLÉCOMMANDE
- > CONTRÔLABLE PAR GROUPE
- > RENDEMENT LUMINEUX ÉLEVÉ
- > SOLUTIONS D'ÉCLAIRAGE MODERNES ET INNOVANTES
- > POSSIBILITÉ DE CONTRÔLER LA LUMINOSITÉ ET LA COULEUR DE LA LUMIÈRE POUR DES AMBIANCES PERSONNALISÉES

OVERVIEW



This product is available in different colors and shapes./ Dieser Artikel ist in unterschiedlichen Farben und Formen verfügbar./
Cet article est disponible en différentes couleurs et formes.

MAXIMUM FLEXIBILITY / MAXIMALE FLEXIBILITÄT / FLEXIBILITÉ MAXIMALE



With the TRACK PLUS solution you are able to fulfil multiple use cases:

- › Wall and ceiling installation
- › Use the power supply in deported or directly connected to the track
- › Create L, T and X shapes with the included connectors

Mit der TRACK PLUS-Lösung sind Sie in der Lage, mehrere Anwendungsfälle zu erfüllen:

- › Wand- und Deckenmontage
- › Verwenden Sie die Stromzufuhr versetzt oder direkt an der Schiene angeschlossen
- › Erstellen Sie L-, T- und X-Formen mit den mitgelieferten Verbindern

La solution TRACK PLUS permet de répondre à de multiples cas d'utilisation :

- › Installation au mur et au plafond
- › Utiliser l'alimentation électrique en déporté ou directement connectée au rail
- › Créez des formes en L, T et X avec les connecteurs inclus.

REMOTE CONTROLLABLE / FERNSTEUERBAR / CONTRÔLABLE À DISTANCE

- › Choose a timer (15/30/45 minutes)
- › Dimmable & Lightcolor change
- › Group selection (Group: A, B, A+B)
- › Select two favorites

- › Wählen Sie einen Timer (15/30/45 Minuten)
- › Dimmen & Lichtfarbenwechsel
- › Gruppenauswahl (Gruppe: A, B, A+B)
- › Zwei Favoriten auswählen

- › Choix d'une minuterie (15/30/45 minutes)
- › Dimmable et changement de couleur de lumière
- › Sélection de groupe (groupe : A, B, A+B)
- › Sélection de deux favoris



YOUR TRACK PLUS SYSTEM IN 3 STEPS / IHR TRACK PLUS SYSTEM IN 3 SCHRITTEN / VOTRE SYSTÈME TRACK PLUS EN 3 ÉTAPES

1 STARTER SET / STARTER-SET / KIT DE DÉMARRAGE



2 EXTENSION SET / VERLÄNGERUNGS-SET / KIT DE RALLONGE



Connectors to create lines, wall to ceiling connection, L, T and X connections are included in the kits. / Verbindungsstücke zum Erstellen von Geraden, Wand-Decken-Verbindungen, L-, T- und X-Verbindungen sind in den Kits enthalten. / Des connecteurs pour créer des lignes, des connexions mur-plafond, des connexions L, T et X sont inclus dans les kits.

3 LIGHTING / BELEUCHTUNG / ECLAIRAGE



Choose among the 5 lighting modules to create your own atmosphere. Each CCT light can bring high lumen output, around 900 lumen.

Wählen Sie zwischen den 5 Beleuchtungsmodulen, um Ihre eigene Atmosphäre zu schaffen. Jedes CCT-Licht hat eine hohe Lichtausbeute von etwa 900 lm. Jedes CCT-Licht kann einen hohen Lumen-Output von etwa 900 Lumen liefern.

Choisissez parmi les 5 modules d'éclairage pour créer votre propre atmosphère. Chaque lumière CCT peut fournir un rendement lumineux élevé, d'environ 900 lumens.

1 TPLUS STARTER SET

The starter set contains:

- > 1x remote control
- > 1x track 0.95m
- > 1x driver (48W) + connector for deposed setup
- > 1x ceiling to wall connector
- > 2x covers
- > 2x end cap

Das Starter-Set enthält:

- > 1x Fernbedienung
- > 1x Schiene 0,95m
- > 1x Treiber (48W) + Verbinder für versetztes Netzteil
- > 1x Wand-Decken-Verbinder (Kreuz)
- > 2x Abdeckungen
- > 2x Endkappe

Le kit de démarrage comprend :

- > 1x télécommande
- > 1x rail de 0,95m
- > 1x driver (48W) + connecteur pour installation déportée
- > 1x connecteur plafond-mur
- > 2x caches
- > 2x embout

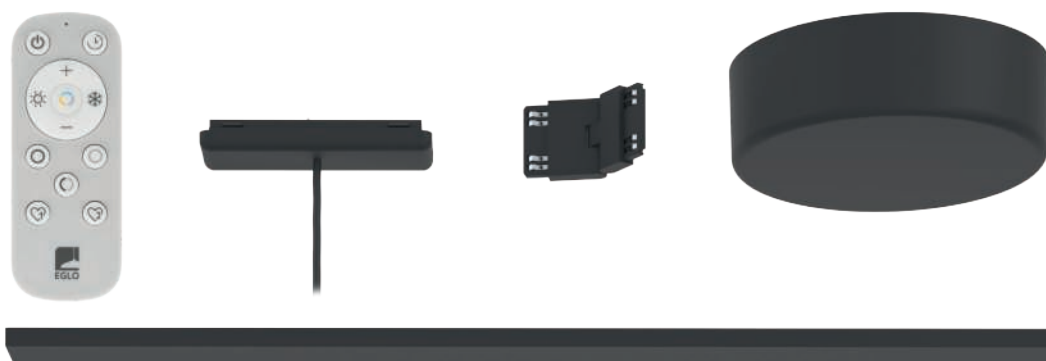

901753

2 TPLUS EXTENSION

The Extension set contains:

- > 1x rail 0.95m
- > 2x connectors (straight)
- > 1x adjustable connector
- > 2x covers
- > 1x end cap

Das Verlängerungs-Set enthält:

- > 1x Schiene 0,95m
- > 2x Verbinder (Gerade)
- > 1x verstellbarer Verbinder
- > 2x Abdeckungen
- > 1x Endkappe

Le kit de rallonge comprend :

- > 1x rail de 0,95m
- > 2x connecteurs (droit)
- > 1x connecteur réglable
- > 2x caches
- > 1x embout

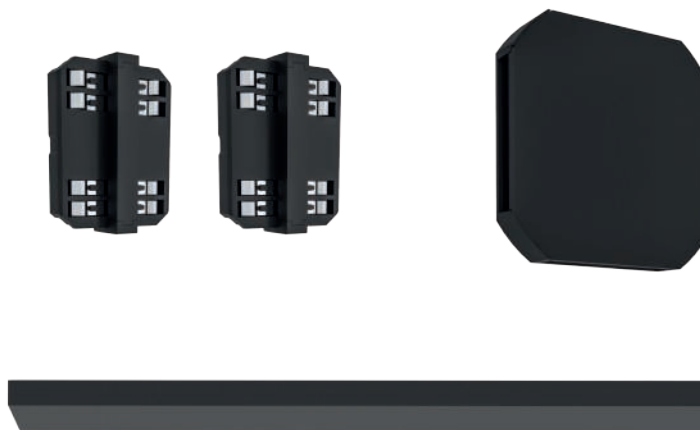

901669

901753 TPLUS STARTER SET

accessory; plastic, black
Zubehör; Kunststoff, schwarz
Accessoires; plastique, noir

L 950, B 30, H 6

901669 TPLUS EXTENSION

accessory; plastic, black
Zubehör; Kunststoff, schwarz
Accessoires; plastique, noir

L 950, B 30, H 6



9 008606 329625



L 950



9 008606 323159



L 950





901683 TPLUS SLIM SPOT

spot; plastic, black
Spot; Kunststoff, schwarz
spot; plastique, noir

L 120, H 140, Ø 55



901684 TPLUS WIDE SPOT

spot; plastic, black
Spot; Kunststoff, schwarz
spot; plastique, noir

L 120, H 40, Ø 85



901685 TPLUS FLAT LIGHT

ceiling light; plastic, black
Deckenleuchte; Kunststoff, schwarz
plafonnier; plastique, noir

L 300, B 30, H 12

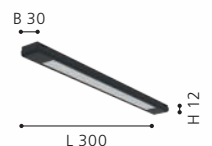



901687



901686



901687 TPLUS PENDANT

spot; plastic, black
Spot; Kunststoff, schwarz
spot; plastique, noir

L 120, H 1100, Ø 55



901686 TPLUS 6 LENS SPOT

spot; plastic, black
Spot; Kunststoff, schwarz
spot; plastique, noir

L 180, B 40, H 30

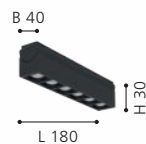

1 TPLUS STARTER SET

The starter set contains:

- > 1x remote control
- > 1x track 0.95m
- > 1x driver (48W) + connector for deported setup
- > 1x ceiling to wall connector
- > 2x covers
- > 2x end cap

Das Starter-Set enthält:

- > 1x Fernbedienung
- > 1x Schiene 0,95m
- > 1x Treiber (48W) + Verbinder für versetztes Netzteil
- > 1x Wand-Decken-Verbinder (Kreuz)
- > 2x Abdeckungen
- > 2x Endkappe

Le kit de démarrage comprend :

- > 1x télécommande
- > 1x rail de 0,95m
- > 1x driver (48W) + connecteur pour installation déportée
- > 1x connecteur plafond-mur
- > 2x caches
- > 2x embout



901754

2 TPLUS EXTENSION

The Extension set contains:

- > 1x rail 0.95m
- > 2x connectors (straight)
- > 1x adjustable connector
- > 2x covers
- > 1x end cap

Das Verlängerungs-Set enthält:

- > 1x Schiene 0,95m
- > 2x Verbinder (Gerade)
- > 1x verstellbarer Verbinder
- > 2x Abdeckungen
- > 1x Endkappe

Le kit de rallonge comprend :

- > 1x rail de 0,95m
- > 2x connecteurs (droit)
- > 1x connecteur réglable
- > 2x caches
- > 1x embout



901691

901754 TPLUS STARTER SET

accessory; plastic, white
Zubehör; Kunststoff, weiss
Accessoires; plastique, blanc

L 950, B 30, H 6

901691 TPLUS EXTENSION

accessory; plastic, white
Zubehör; Kunststoff, weiss
Accessoires; plastique, blanc

L 950, B 30, H 6



9 008606 329632



L 950



9 008606 323319



L 950





901706



901707



901708



901706 TPLUS SLIM SPOT

spot; plastic, white
Spot; Kunststoff, weiss
spot; plastique, blanc

L 120, H 140, Ø 55



9 008606 323234



901707 TPLUS WIDE SPOT

spot; plastic, white
Spot; Kunststoff, weiss
spot; plastique, blanc

L 120, H 40, Ø 85



9 008606 323241



901708 TPLUS FLAT LIGHT

ceiling light; plastic, white
Deckenleuchte; Kunststoff, weiss
plafonnier; plastique, blanc

L 300, B 30, H 12



9 008606 323258

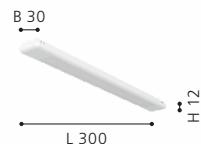



901711



901709



901711 TPLUS PENDANT

spot; plastic, white
Spot; Kunststoff, weiss
spot; plastique, blanc

L 120, H 1100, Ø 55

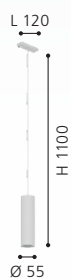

901709 TPLUS 6 LENS SPOT

spot; plastic, white
Spot; Kunststoff, weiss
spot; plastique, blanc

L 180, B 40, H 30

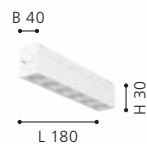



LED PANEL LUMINAIRES

ADVANTAGES

- > SURFACE LIGHT - CLEAR LINES AND FLAT DESIGN
 - > ENERGY-EFFICIENT AND COST-SAVING THANKS TO LED TECHNOLOGY
 - > MULTIPLE APPLICATION POSSIBILITIES: LIVING ROOM, BEDROOM, HOME OFFICE, KITCHEN, CELLAR, WORK SURFACES, HALLWAY AND MUCH MORE.
 - > MODERN TECHNOLOGY
 - > FUNCTIONS FROM ON/OFF TO RGBW
 - > DIFFERENT MATERIALS – METAL, PLASTIC
-

VORTEILE

- > FLÄCHENLICHT – KLARE LINIEN UND FLACHE BAUFORM
 - > ENERGIEEFFIZIENT UND KOSTENSPAREND DURCH LED-TECHNOLOGIE
 - > DIVERSE EINSATZMÖGLICHKEITEN: WOHNZIMMER, SCHLAFZIMMER, HOMEOFFICE, KÜCHE, KELLER, ARBEITSFLÄCHEN, FLUR, UVM.
 - > MODERNE TECHNIK
 - > FUNKTIONEN VON ON/OFF BIS RGBW
 - > VERSCHIEDENE MATERIALIEN – METALL, KUNSTSTOFF
-

AVANTAGES

- > ÉCLAIRAGE DE SURFACE - LIGNES CLAIRES ET DESIGN PLAT
- > EFFICACITÉ ÉNERGÉTIQUE ET ÉCONOMIE DE COÛTS GRÂCE À LA TECHNOLOGIE LED
- > MULTIPLES POSSIBILITÉS D'UTILISATION : SALON, CHAMBRE À COUCHER, BUREAU À DOMICILE, CUISINE, CAVE, PLANS DE TRAVAIL, COULOIR ET BIEN PLUS ENCORE.
- > TECHNOLOGIE MODERNE
- > FONCTIONS DE ON/OFF À RGBW
- > DIFFÉRENTS MATÉRIAUX – MÉTAL, PLASTIQUE



LED PANEL FUNCTION

| Item no. Art.-Nr. N° d'art. | Series name Seriename Nom de la série | Dimensions Größe Dimensions | Page Seite Page | warm white warmweiß blanc chaud | neutral white neutralweiß blanc neutre | tunable white tunable white tunable white | RGB RGB RGB |
|-----------------------------------|---|-----------------------------------|-----------------------|---------------------------------------|--|---|-------------------|
| 901438 | ROVITO | H 30, Ø 300 | 136 | | | • | |
| 901439 | ROVITO | H 30, Ø 390 | 136 | | | • | |
| 901441 | ROVITO | H 32, Ø 500 | 136 | | | • | |
| 901442 | ROVITO | L 290, B 290, H 30 | 137 | | | • | |
| 901443 | ROVITO | L 390, B 390, H 30 | 137 | | | • | |
| 901444 | ROVITO | L 500, B 500, H 32 | 138 | | | • | |
| 901445 | ROVITO | L 570, B 300, H 30 | 138 | | | • | |
| 901452 | ROVITO | L 500, B 500, H 32 | 139 | | | • | |
| 901453 | ROVITO | L 570, B 300, H 30 | 139 | | | • | |
| 901446 | ROVITO | H 30, Ø 300 | 140 | | | • | |
| 901447 | ROVITO | H 30, Ø 390 | 140 | | | • | |
| 901448 | ROVITO | H 32, Ø 500 | 140 | | | • | |
| 901449 | ROVITO | L 290, B 290, H 30 | 141 | | | • | |
| 901451 | ROVITO | L 390, B 390, H 30 | 141 | | | • | |
| 901454 | ROVITO-R | H 30, Ø 390 | 142 | | | • | |
| 901455 | ROVITO-R | H 32, Ø 500 | 142 | | | • | |
| 901456 | ROVITO-R | L 390, B 390, H 30 | 143 | | | • | |
| 901457 | ROVITO-R | L 500, B 500, H 32 | 143 | | | • | |
| 901458 | ROVITO-R | H 30, Ø 390 | 144 | | | • | |
| 901459 | ROVITO-R | H 32, Ø 500 | 144 | | | • | |
| 901461 | ROVITO-R | L 390, B 390, H 30 | 145 | | | • | |
| 901462 | ROVITO-R | L 500, B 500, H 32 | 145 | | | • | |
| 99728 | URTEBIETA | L 595, B 595, H 50 | 146 | | • | | |
| 99729 | URTEBIETA | L 1195, B 295, H 50 | 146 | | • | | |
| 32812 | SALOBRENA 1 | L 300, B 300, H 50 | 148 | | • | | |
| 98129 | SALOBRENA 1 | L 450, B 450, H 50 | 148 | | • | | |
| 32811 | SALOBRENA 1 | L 1200, B 300, H 50 | 149 | | • | | |
| 32813 | SALOBRENA 1 | L 595, B 595, H 50 | 149 | | • | | |
| 98025 | SALOBRENA 1 | L 1195, B 100, H 45 | 149 | | • | | |
| 900818 | SALOBRENA 1 | L 450, B 450, H 50 | 150 | | • | | |
| 900817 | SALOBRENA 1 | L 300, B 300, H 50 | 150 | | • | | |
| 900819 | SALOBRENA 1 | L 595, B 595, H 50 | 151 | | • | | |
| 900821 | SALOBRENA 1 | L 1200, B 300, H 50 | 151 | | • | | |
| 900822 | SALOBRENA 1 | L 1195, B 100, H 45 | 151 | | • | | |
| 98201 | SALOBRENA-A | L 300, B 300, H 50 | 152 | | | • | |
| 98203 | SALOBRENA-A | L 600, B 600, H 50 | 152 | | | • | |
| 98297 | SALOBRENA-A | L 450, B 450, H 50 | 152 | | | • | |
| 98205 | SALOBRENA-A | L 1200, B 300, H 50 | 153 | | | • | |
| 98206 | SALOBRENA-A | L 1195, B 100, H 50 | 153 | | | • | |
| 98418 | SALOBRENA-M | L 595, B 595, H 50 | 154 | | | | |
| 98419 | SALOBRENA-M | L 1195, B 295, H 50 | 154 | | | | |
| 98766 | SALOBRENA-B | L 595, B 595, H 55 | 155 | | | • | • |
| 98767 | SALOBRENA-B | L 1200, B 300, H 55 | 155 | | | • | • |
| 33107 | SALOBRENA-RGBW | L 450, B 450, H 11 | 156 | | | • | • |
| 33108 | SALOBRENA-RGBW | L 600, B 300, H 11 | 156 | | | • | • |

LED PANEL FUNCTION

| Item no. Art.-Nr. N° d'art. | Series name Seriennamen Nom de la série | Dimensions Größe Dimensions | Page Seite Page | warm white warmweiß blanc chaud | neutral white neutralweiß blanc neutre | tunable white tunable white tunable white | RGB RGB RGB |
|-----------------------------------|---|-----------------------------------|-----------------------|---------------------------------------|--|---|-------------------|
| 900937 | RABASSA | L 595, B 595, H 27 | 158 | | • | | |
| 900939 | RABASSA | L 1195, B 295, H 27 | 158 | | • | | |
| 900938 | RABASSA | L 620, B 620, H 27 | 158 | • | • | | • |
| 96152 | SALOBRENA 1 | L 300, B 300, H 11 | 160 | • | • | | • |
| 96153 | SALOBRENA 1 | L 595, B 595, H 11 | 160 | • | • | | • |
| 96154 | SALOBRENA 1 | L 620, B 620, H 11 | 160 | • | • | | • |
| 96151 | SALOBRENA 1 | L 1200, B 300, H 11 | 161 | | • | | |
| 97502 | SARSINA | H 50, Ø 450 | 164 | | • | | |
| 97503 | SARSINA | H 50, Ø 600 | 164 | | • | | |
| 97501 | SARSINA | H 50, Ø 300 | 164 | | • | | |
| 98208 | SARSINA-A | H 50, Ø 450 | 165 | | | • | |
| 98209 | SARSINA-A | H 50, Ø 600 | 165 | | | • | |
| 98207 | SARSINA-A | H 50, Ø 300 | 165 | | | • | |
| 99833 | TURCONA-CCT | L 287, B 287, H 62 | 168 | | | • | |
| 99834 | TURCONA-CCT | L 437, B 437, H 70 | 169 | | | • | |
| 99835 | TURCONA-CCT | L 587, B 587, H 70 | 169 | | | • | |
| 99836 | TURCONA-CCT | L 1187, B 287, H 70 | 169 | | | • | |
| 900568 | TRUPIANA | L 437, B 437, H 62 | 170 | | | • | • |
| 900569 | TRUPIANA | L 587, B 587, H 62 | 170 | | | • | • |
| 98901 | TURCONA | L 300, B 300, H 60 | 172 | | • | | |
| 98902 | TURCONA | L 450, B 450, H 60 | 172 | | • | | |
| 98903 | TURCONA | L 595, B 595, H 60 | 172 | | • | | |
| 98904 | TURCONA | L 1200, B 300, H 60 | 173 | | • | | |
| 98905 | TURCONA | L 1200, B 100, H 60 | 173 | | • | | |
| 900961 | ALBARCA | L 588, B 588, H 69 | 174 | | | • | • |
| 900959 | ALBARCA | L 438, B 438, H 69 | 174 | | | • | • |
| 900571 | BORDONARA | L 450, B 450 | 178 | | | • | • |
| 900572 | BORDONARA | L 595, B 595 | 178 | | | • | • |
| 900573 | BORDONARA | L 1195, B 295 | 178 | | | • | • |
| 900558 | MARMORATA | H 70, Ø 450 | 180 | • | | | |
| 900559 | MARMORATA | L 445, B 445 | 180 | • | | | |
| 900561 | MARMORATA | L 595, B 295 | 180 | • | | | |
| 901191 | BALAZOTE | H 50, Ø 380 | 182 | | | • | • |
| 99038 | SAVATARILA | L 450, B 450, H 60 | 183 | | • | | |
| 99039 | SAVATARILA | L 595, B 595, H 60 | 183 | | • | | |
| 901192 | BALAZOTE | L 360, B 360, H 50 | 183 | | | • | • |
| 99842 | LAZARAS | L 450, B 450, H 60 | 185 | • | • | | • |
| 99841 | LAZARAS | H 55, Ø 450 | 185 | • | • | | • |



LED PANEL LUMINAIRES

WITH FRAME

ADVANTAGES

- > SURFACE LIGHT WITH SHADOWLESS LIGHTING
 - > ULTRA-FLAT DESIGN
 - > HOMOGENEOUS SURFACE LIGHTING
 - > SIMPLE INSTALLATION
 - > ELEGANT SUSPENSION FRAME INCLUDED
 - > ALSO FOR FLUSH MOUNTING SUITABLE
-

VORTEILE

- > FLÄCHIGES LICHT MIT SCHATTENFREIER AUSLEUCHTUNG
 - > ULTRAFLACHES DESIGN
 - > HOMOGENE FLÄCHENAUSLEUCHTUNG
 - > EINFACHE MONTAGE
 - > INKL. ELEGANTEM SCHWEBERAHMEN
 - > AUCH FÜR FLÄCHENBÜNDIGEN EINBAU GEEIGNET
-

AVANTAGES

- > ÉCLAIRAGE ÉTALÉ AVEC ÉCLAIREMENT
- > SANS OMBRE
- > DESIGN ULTRA PLAT
- > ÉCLAIRAGE DE SURFACE HOMOGENÈ
- > MONTAGE SIMPLE
- > BÂTI FLOTTANT ÉLÉGANT INCLUS ADAPTÉ AU MONTAGE ENCASTRÉ

OVERVIEW

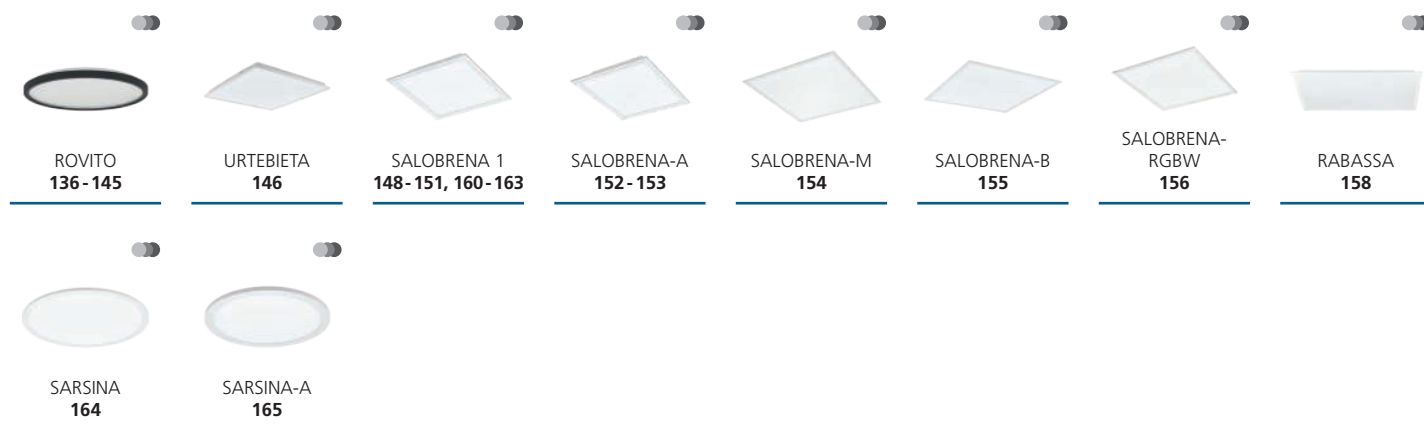

ACCESSORIES INCLUDED

All luminaires including Suspension frame
 Alle Leuchten inklusive Schweberahmen
 Tous les luminaires inclus bâti flottant

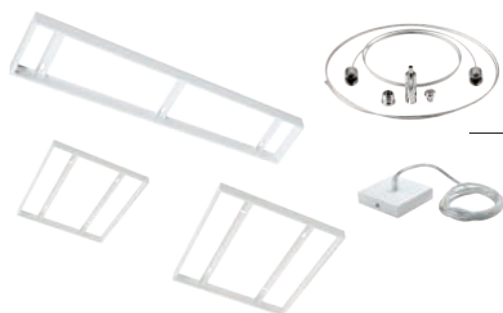

ACCESSORIES OPTIONAL

PAGE / SEITE / PAGE **162-163**



This product is available in different colors and shapes./ Dieser Artikel ist in unterschiedlichen Farben und Formen verfügbar./
 Cet article est disponible en différentes couleurs et formes.



901438



IP44



901439



IP44



901441



IP44

901438 ROVITO

ceiling light; plastic, black / plastic, white
Deckenleuchte; Kunststoff, schwarz / Kunststoff, weiss
plafonnier; plastique, noir / plastique, blanc

H 30, Ø 300



14,4W 1800lm

901439 ROVITO

ceiling light; plastic, black / plastic, white
Deckenleuchte; Kunststoff, schwarz / Kunststoff, weiss
plafonnier; plastique, noir / plastique, blanc

H 30, Ø 390

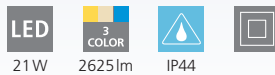

21W 2625lm

901441 ROVITO

ceiling light; plastic, black / plastic, white
Deckenleuchte; Kunststoff, schwarz / Kunststoff, weiss
plafonnier; plastique, noir / plastique, blanc

H 32, Ø 500



28,8W 3600lm



9 008606 329847

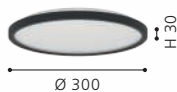

9 008606 329854



9 008606 329861





901442



IP44



ROVITO

The light colour of these lights can be controlled in three steps via dip switch.

Die Lichtfarbe diese Leuchten können mittels Dip-Schalter in drei Stufen gesteuert werden.

La couleur de la lumière de ces lampes peut être contrôlée en trois étapes à l'aide d'un interrupteur DIP.

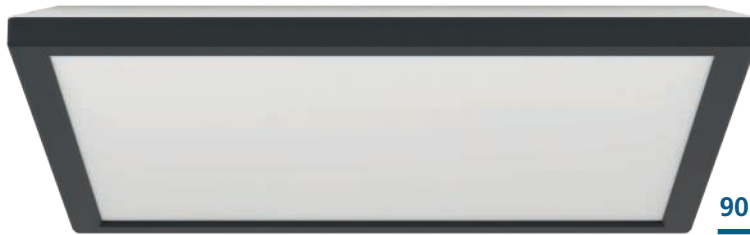

901443



IP44

901442 ROVITO

ceiling light; plastic, black / plastic, white
Deckenleuchte; Kunststoff, schwarz / Kunststoff, weiss
plafonnier; plastique, noir / plastique, blanc

L 290, B 290, H 30



14,4W



2000lm



IP44



901443 ROVITO

ceiling light; plastic, black / plastic, white
Deckenleuchte; Kunststoff, schwarz / Kunststoff, weiss
plafonnier; plastique, noir / plastique, blanc

L 390, B 390, H 30



21W



3000lm



IP44



9 008606 329878



9 008606 329885

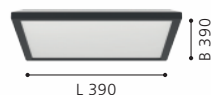

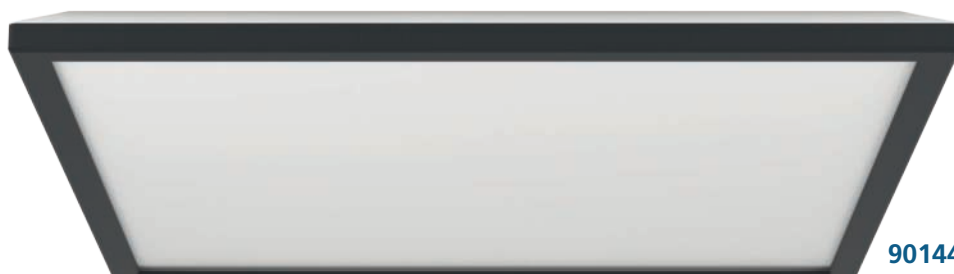

901444



IP44

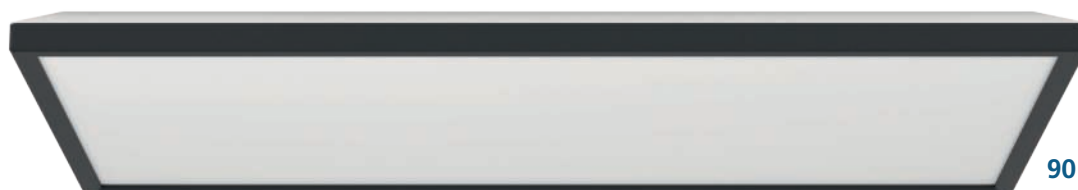

901445



IP44

901444 ROVITO

ceiling light; plastic, black / plastic, white
Deckenleuchte; Kunststoff, schwarz / Kunststoff, weiss
plafonnier; plastique, noir / plastique, blanc

L 500, B 500, H 32



28,8W



4200lm



IP44



9 008606 329892



L 500

B 500

901445 ROVITO

ceiling light; plastic, black / plastic, white
Deckenleuchte; Kunststoff, schwarz / Kunststoff, weiss
plafonnier; plastique, noir / plastique, blanc

L 570, B 300, H 30



21W



3000lm



IP44



9 008606 329908



L 570

B 300

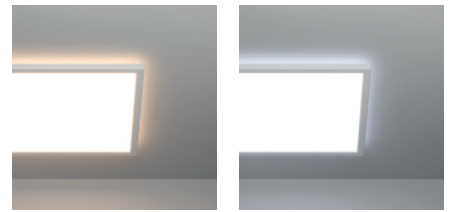

ROVITO

The light colour of these lights can be controlled in three steps via dip switch.

Die Lichtfarbe diese Leuchten können mittels Dip-Schalter in drei Stufen gesteuert werden.

La couleur de la lumière de ces lampes peut être contrôlée en trois étapes à l'aide d'un interrupteur DIP.

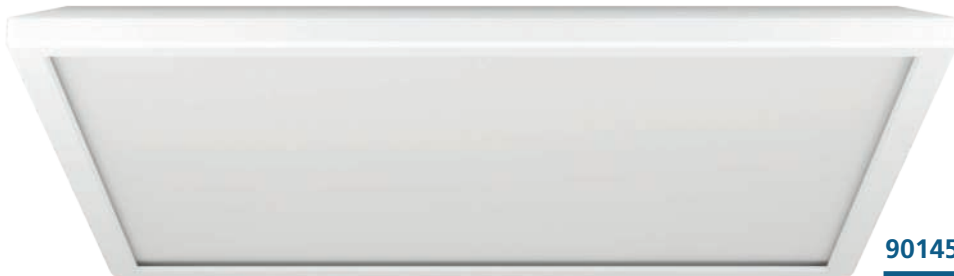

901452



IP44



901453



IP44

901452 ROVITO

ceiling light; plastic, white / plastic, white
Deckenleuchte; Kunststoff, weiss / Kunststoff, weiss
plafonnier; plastique, blanc / plastique, blanc

L 500, B 500, H 32



28,8 W



4200 lm



IP44



901453 ROVITO

ceiling light; plastic, white / plastic, white
Deckenleuchte; Kunststoff, weiss / Kunststoff, weiss
plafonnier; plastique, blanc / plastique, blanc

L 570, B 300, H 30



21 W



3000 lm



IP44



9 008606 329960



9 008606 329977

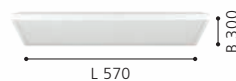

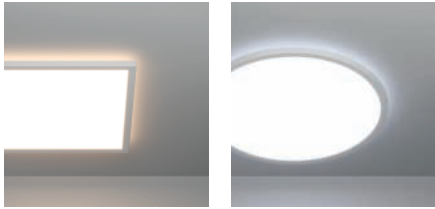

ROVITO

The light colour of these lights can be controlled in three steps via dip switch.

Die Lichtfarbe diese Leuchten können mittels Dip-Schalter in drei Stufen gesteuert werden.

La couleur de la lumière de ces lampes peut être contrôlée en trois étapes à l'aide d'un interrupteur DIP.



901446



IP44



901447



IP44



901448



IP44

901446 ROVITO

ceiling light; plastic, white / plastic, white
Deckenleuchte; Kunststoff, weiss / Kunststoff, weiss
plafonnier; plastique, blanc / plastique, blanc

H 30, Ø 300



14,4W 1800lm

901447 ROVITO

ceiling light; plastic, white / plastic, white
Deckenleuchte; Kunststoff, weiss / Kunststoff, weiss
plafonnier; plastique, blanc / plastique, blanc

H 30, Ø 390



21W 2625lm

901448 ROVITO

ceiling light; plastic, white / plastic, white
Deckenleuchte; Kunststoff, weiss / Kunststoff, weiss
plafonnier; plastique, blanc / plastique, blanc

H 32, Ø 500

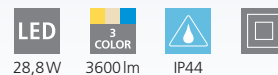

28,8W 3600lm



9 008606 329915

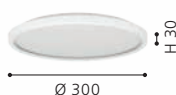

9 008606 329922



9 008606 329939

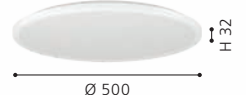



901449



IP44



901451



IP44

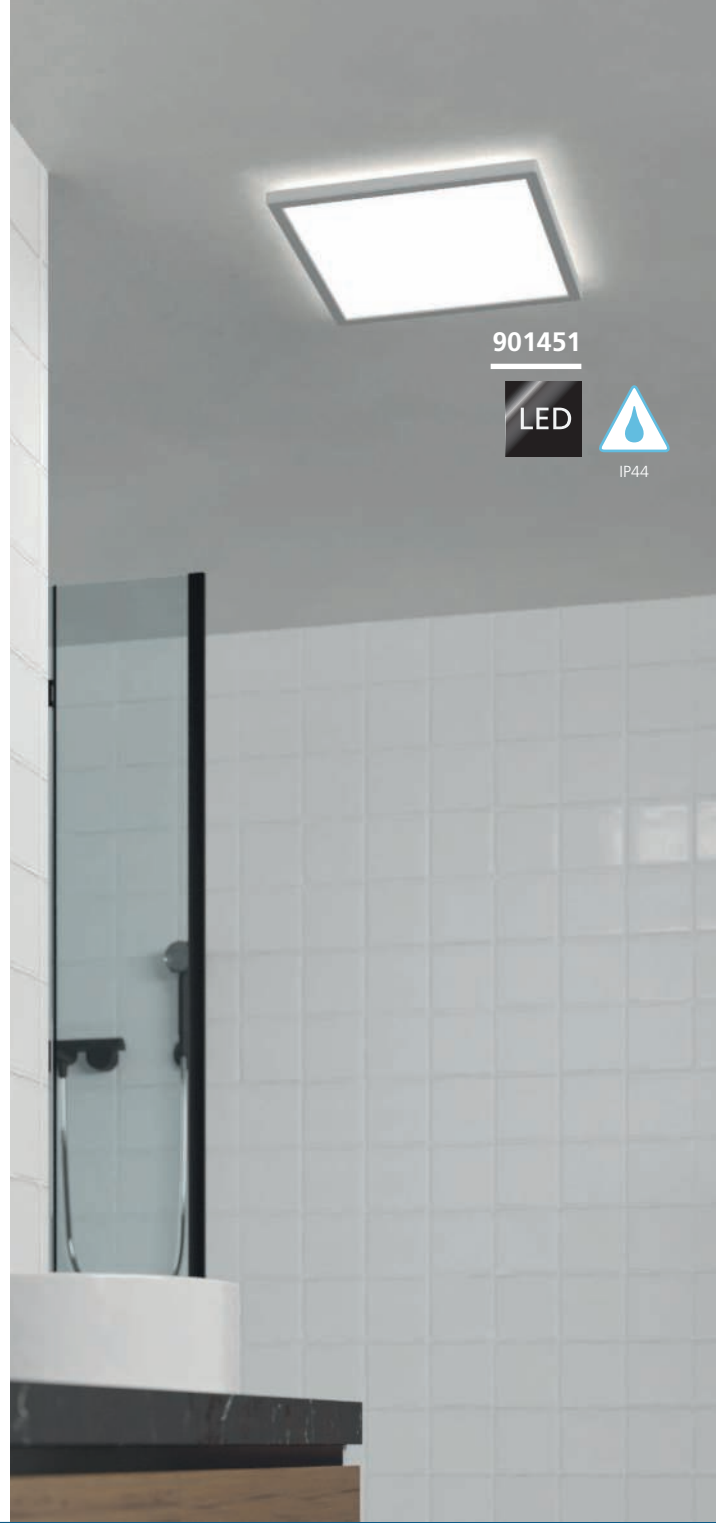

901451



IP44

901449 ROVITO

ceiling light; plastic, white / plastic, white
Deckenleuchte; Kunststoff, weiss / Kunststoff, weiss
plafonnier; plastique, blanc / plastique, blanc

L 290, B 290, H 30



14,4W



2000lm



IP44



901451 ROVITO

ceiling light; plastic, white / plastic, white
Deckenleuchte; Kunststoff, weiss / Kunststoff, weiss
plafonnier; plastique, blanc / plastique, blanc

L 390, B 390, H 30



21W



3000lm



IP44



9 008606 329946



L 290



9 008606 329953



L 390



901454



IP44



REMOTE+

Our new 2.4 GHz REMOTE+ makes it easier than ever to control your luminaires. With its user-friendly design and simple control, you can easily adjust your luminaires to create the perfect ambiance for any occasion:

- > Stepless Dimming
- > Quick Pairing
- > Timer Function
- > Stepless Tunable White
- > Memory Effect
- > Control up to 10 REMOTE+ luminaires

Unsere neue 2,4-GHz REMOTE+ macht die Steuerung Ihrer Leuchten so einfach wie nie zuvor. Mit ihrem benutzerfreundlichen Design und der einfachen Steuerung können Sie Ihre Leuchten ganz einfach einstellen, um das perfekte Ambiente für jede Gelegenheit zu schaffen:

- > Stufenloses Dimmen
- > Schnelle Kopplung
- > Timer-Funktion
- > Stufenlos einstellbares Weiß
- > Memory-Effekt
- > Steuerung von bis zu 10 REMOTE+-Leuchten

Notre nouvelle REMOTE+ 2,4 GHz facilite plus que jamais le contrôle de vos lumières. Grâce à sa conception conviviale et à sa commande simple, vous pouvez facilement régler votre luminaire pour créer l'ambiance parfaite en toute occasion:

- > Gradation progressive
- > appairage rapide
- > Fonction de minuterie
- > Blanc réglable en continu
- > Effet de mémoire
- > Contrôle jusqu'à 10 luminaires REMOTE



901455



IP44



901454 ROVITO-R

ceiling light; plastic, black / plastic, white
Deckenleuchte; Kunststoff, schwarz / Kunststoff, weiss
plafonnier; plastique, noir / plastique, blanc

H 30, Ø 390



21W



2625lm



Remote



IP44



9 008606 329984

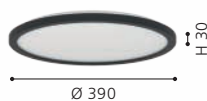

901455 ROVITO-R

ceiling light; plastic, black / plastic, white
Deckenleuchte; Kunststoff, schwarz / Kunststoff, weiss
plafonnier; plastique, noir / plastique, blanc

H 32, Ø 500



28,8W



3600lm



Remote



IP44



9 008606 329991

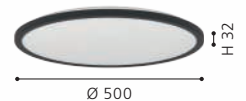



901456



incl./inkl./inclus



ROVITO-R

These lights have individually controllable light settings on the inside and outside of the frame.

Diese Leuchten verfügen über individuell steuerbare Lichteinstellungen der Rahmen innen und außen.

Ces lumières ont des paramètres d'éclairage contrôlables individuellement du cadre.



901457



incl./inkl./inclus



901456 ROVITO-R

ceiling light; plastic, black / plastic, white
Deckenleuchte; Kunststoff, schwarz / Kunststoff, weiss
plafonnier; plastique, noir / plastique, blanc

L 390, B 390, H 30



21 W



3000lm



Remote



IP44



9 008606 330003



901457 ROVITO-R

ceiling light; plastic, black / plastic, white
Deckenleuchte; Kunststoff, schwarz / Kunststoff, weiss
plafonnier; plastique, noir / plastique, blanc

L 500, B 500, H 32



28,8 W



4200lm



Remote



IP44



9 008606 330010

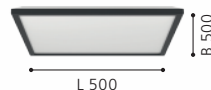



901458



IP44

incl./inkl./inclus



901459



IP44

incl./inkl./inclus



901458 ROVITO-R

ceiling light; plastic, white / plastic, white
 Deckenleuchte; Kunststoff, weiss / Kunststoff, weiss
 plafonnier; plastique, blanc / plastique, blanc

H 30, Ø 390



21W



2625lm



Remote



IP44



9 008606 330027



901459 ROVITO-R

ceiling light; plastic, white / plastic, white
 Deckenleuchte; Kunststoff, weiss / Kunststoff, weiss
 plafonnier; plastique, blanc / plastique, blanc

H 32, Ø 500



28,8W



3600lm



Remote



IP44



9 008606 330034

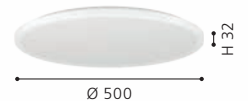



901461



incl./inkl./inclus

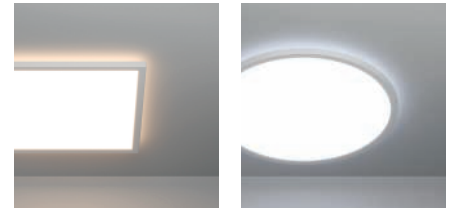

ROVITO-R

These lights have individually controllable light settings on the inside and outside of the frame.

Diese Leuchten verfügen über individuell steuerbare Lichteinstellungen der Rahmen innen und außen.

Ces lumières ont des paramètres d'éclairage contrôlables individuellement du cadre.



901462



incl./inkl./inclus



901461 ROVITO-R

ceiling light; plastic, white / plastic, white
Deckenleuchte; Kunststoff, weiss / Kunststoff, weiss
plafonnier; plastique, blanc / plastique, blanc

L 390, B 390, H 30



21 W



3000lm



Remote



IP44



9 008606 330041

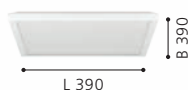

901462 ROVITO-R

ceiling light; plastic, white / plastic, white
Deckenleuchte; Kunststoff, weiss / Kunststoff, weiss
plafonnier; plastique, blanc / plastique, blanc

L 500, B 500, H 32



28,8 W



4200lm



Remote



IP44



9 008606 330058





99728



99729



99729

These luminaires are very suitable for the home office due to their reduced glare.

Diese Leuchten sind aufgrund ihres reduzierten Blendeffekts sehr gut für das Homeoffice geeignet.

These luminaires are very suitable for the home office due to their reduced glare.

99728 URTEBIETA

ceiling light; steel, white / plastic, white
 Deckenleuchte; Stahl, weiss / Kunststoff, weiss
 plafonnier; acier, blanc / plastique, blanc

L 595, B 595, H 50



32W 4700lm

99729 URTEBIETA

ceiling light; steel, white / plastic, white
 Deckenleuchte; Stahl, weiss / Kunststoff, weiss
 plafonnier; acier, blanc / plastique, blanc

L 1195, B 295, H 50



32W 4700lm



9 002759 997281

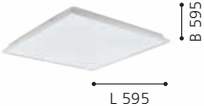

9 002759 997298





99729

LED



32813

LED



32812

LED



98129

LED

32812 SALOBRENA 1

ceiling light; aluminium, steel, white / plastic, white
Deckenleuchte; Alu, Stahl, weiss / Kunststoff, weiss
plafonnier; aluminium, acier, blanc / plastique, blanc

L 300, B 300, H 50



14W



2000lm



98129 SALOBRENA 1

ceiling light; aluminium, white / plastic, white
Deckenleuchte; Alu, weiss / Kunststoff, weiss
plafonnier; aluminium, blanc / plastique, blanc

L 450, B 450, H 50



21,5W



3000lm



9 002759 328122

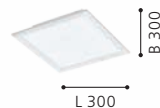

9 002759 981297

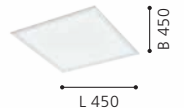



32813

LED



32811

LED



98025

LED

32813 SALOBRENA 1

ceiling light; aluminium, steel, white / plastic, white
Deckenleuchte; Alu, Stahl, weiss / Kunststoff, weiss
plafonnier; aluminium, acier, blanc / plastique, blanc

L 595, B 595, H 50



33W 4700lm

32811 SALOBRENA 1

ceiling light; aluminium, steel, white / plastic, white
Deckenleuchte; Alu, Stahl, weiss / Kunststoff, weiss
plafonnier; aluminium, acier, blanc / plastique, blanc

L 1200, B 300, H 50



33W 4700lm

98025 SALOBRENA 1

ceiling light; aluminium, white / plastic, white
Deckenleuchte; Alu, weiss / Kunststoff, weiss
plafonnier; aluminium, blanc / plastique, blanc

L 1195, B 100, H 45



38W 4700lm



9 002759 328139

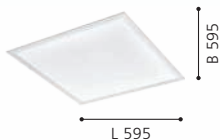

L 595



9 002759 328115

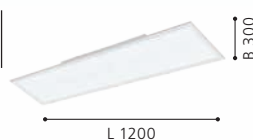

L 1200



9 002759 980252



L 1195



900817



900817



900818



900817 SALOBRENA 1

ceiling light; aluminium, steel, black / plastic, white
 Deckenleuchte; Alu, Stahl, schwarz / Kunststoff, weiss
 plafonnier; aluminium, acier, noir / plastique, blanc

L 300, B 300, H 50



14W 2000lm

900818 SALOBRENA 1

ceiling light; aluminium, black / plastic, white
 Deckenleuchte; Alu, schwarz / Kunststoff, weiss
 plafonnier; aluminium, noir / plastique, blanc

L 450, B 450, H 50



21,5W 3000lm



9 008606 259854



9 008606 259861





900819



900821



900822



900819 SALOBRENA 1

ceiling light; aluminium, steel, black / plastic, white
Deckenleuchte; Alu, Stahl, schwarz / Kunststoff, weiss
plafonnier; aluminium, acier, noir / plastique, blanc

L 595, B 595, H 50



33W



4700lm



900821 SALOBRENA 1

ceiling light; aluminium, steel, black / plastic, white
Deckenleuchte; Alu, Stahl, schwarz / Kunststoff, weiss
plafonnier; aluminium, acier, noir / plastique, blanc

L 1200, B 300, H 50



33W



4700lm



900822 SALOBRENA 1

ceiling light; aluminium, black / plastic, white
Deckenleuchte; Alu, schwarz / Kunststoff, weiss
plafonnier; aluminium, noir / plastique, blanc

L 1195, B 100, H 45



38W



4700lm



9 008606 259878



L 595

B 595



9 008606 259885



L 1200

B 300



9 008606 259892



L 1195

B 100



98201

LED



incl./inkl./inclus

98297

LED



incl./inkl./inclus

98203

LED



incl./inkl./inclus

98201 SALOBRENA-A

ceiling light; aluminium, white / plastic, white
Deckenleuchte; Alu, weiss / Kunststoff, weiss
plafonnier; aluminium, blanc / plastique, blanc

L 300, B 300, H 50



98297 SALOBRENA-A

ceiling light; aluminium, white / plastic, white
Deckenleuchte; Alu, weiss / Kunststoff, weiss
plafonnier; aluminium, blanc / plastique, blanc

L 450, B 450, H 50



98203 SALOBRENA-A

ceiling light; aluminium, white / plastic, white
Deckenleuchte; Alu, weiss / Kunststoff, weiss
plafonnier; aluminium, blanc / plastique, blanc

L 600, B 600, H 50



9 002759 982010

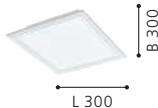

9 002759 982973

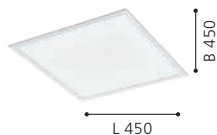

9 002759 982034

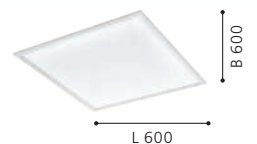



98205



98206



98205 SALOBRENA-A

ceiling light; aluminium, white / plastic, white
Deckenleuchte; Alu, weiss / Kunststoff, weiss
plafonnier; aluminium, blanc / plastique, blanc

L 1200, B 300, H 50



98206 SALOBRENA-A

ceiling light; aluminium, white / plastic, white
Deckenleuchte; Alu, weiss / Kunststoff, weiss
plafonnier; aluminium, blanc / plastique, blanc

L 1195, B 100, H 50

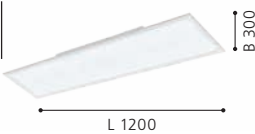



98418



12 m
5 sec. - 15 min.

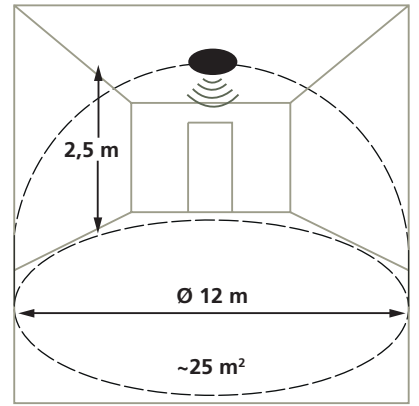

time: 5 sec. - 15 min.

SALOBRENA-M

These luminaires come with an integrated motion sensor. The sensor is not visible.

Diese Leuchten sind mit einem integrierten Bewegungssensor ausgestattet. Der Sensor ist nicht sichtbar.

Ces luminaires viennent avec un capteur de mouvement intégré. Le capteur n'est pas visible.



98419



12 m
5 sec. - 15 min.

98418 SALOBRENA-M

ceiling light; aluminium, white / plastic, white
Deckenleuchte; Alu, weiss / Kunststoff, weiss
plafonnier; aluminium, blanc / plastique, blanc

L 595, B 595, H 50



35W 4600lm



9 002759 984182

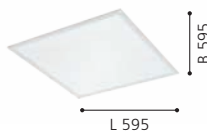

98419 SALOBRENA-M

ceiling light; aluminium, white / plastic, white
Deckenleuchte; Alu, weiss / Kunststoff, weiss
plafonnier; aluminium, blanc / plastique, blanc

L 1195, B 295, H 50



35W 5000lm



9 002759 984199





98766



SALOBRENA-B

The luminaires have an atmospheric indirect RGB light.

Die Leuchten verfügen über ein stimmungsvolles, indirektes RGB-Licht.

Le luminaires dispose d'une lumière d'ambiance indirecte RGB.



98767



98766 SALOBRENA-B

ceiling light; aluminium, steel, white / plastic, white
Deckenleuchte; Alu, Stahl, weiss / Kunststoff, weiss
plafonnier; aluminium, acier, blanc / plastique, blanc

L 595, B 595, H 55



98767 SALOBRENA-B

ceiling light; aluminium, steel, white / plastic, white
Deckenleuchte; Alu, Stahl, weiss / Kunststoff, weiss
plafonnier; aluminium, acier, blanc / plastique, blanc

L 1200, B 300, H 55



9 002759 987664

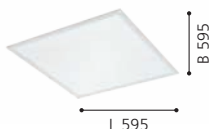

9 002759 987671





33107



incl./inkl./inclus



33108



incl./inkl./inclus

33107 SALOBRENA-RGBW

grid light; aluminium, white / plastic, white
 Rasterleuchte; Alu, weiss / Kunststoff, weiss
 luminaire à grille; aluminium, blanc / plastique, blanc

L 450, B 450, H 11



LED

21W

RGB+NW

2400lm

Remote

33108 SALOBRENA-RGBW

grid light; aluminium, white / plastic, white
 Rasterleuchte; Alu, weiss / Kunststoff, weiss
 luminaire à grille; aluminium, blanc / plastique, blanc

L 600, B 300, H 11



LED

21W

RGB+NW

2400lm

Remote



9 002759 331078

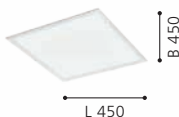

9 002759 331085

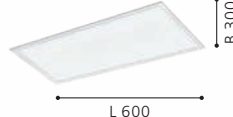

SALOBRENA-RGBW

With the remote control (included in delivery) the following features can be adjusted:

Durch die Fernbedienung (im Lieferumfang enthalten) verfügen diese Leuchten über folgende Funktionen:

Les fonctions différentes peuvent être réglées avec une télécommande incluse avec le luminaire:

- > Color change
- > Change to white light
- > Change to RGB
- > Flash (fast color change)
- > Smooth dimming (slow color change)
10%, 25%, 50%, 100%
- > on/off



33107

LED





900937

LED



900938

LED



900939

LED

900937 RABASSA

grid light; aluminium, white / plastic, white
Rasterleuchte; Alu, weiss / Kunststoff, weiss
luminaire à grille; aluminium, blanc / plastique, blanc

L 595, B 595, H 27



34,5W 4900lm

900938 RABASSA

grid light; aluminium, white / plastic, white
Rasterleuchte; Alu, weiss / Kunststoff, weiss
luminaire à grille; aluminium, blanc / plastique, blanc

L 620, B 620, H 27



33W 5200lm

900939 RABASSA

grid light; aluminium, white / plastic, white
Rasterleuchte; Alu, weiss / Kunststoff, weiss
luminaire à grille; aluminium, blanc / plastique, blanc

L 1195, B 295, H 27



34,5W 4900lm



9 008606 277872



L 595

B 595



9 008606 277889



L 620

B 620



9 008606 277896



L 1195

B 295



900937

LED



GRID LIGHTS SALOBRENA 1

Slim design with 6 mounting options,
Uniform distribution of light - ideal for
illuminating spaces and surfaces.

Schlanke Bauform mit 6 Montagevarianten,
Homogene Lichtverteilung – ideal zur
Beleuchtung von Räumen und Flächen.

Conception mince avec 6 options de montage,
Distribution uniforme de la lumière - idéal pour
l'illumination des espaces et surfaces.



96152



96153



96154



96152 SALOBRENA 1

grid light; aluminium, white / plastic, white
Rasterleuchte; Alu, weiss / Kunststoff, weiss
luminaire à grille; aluminium, blanc / plastique, blanc

L 300, B 300, H 11



14W 2000lm

96153 SALOBRENA 1

grid light; aluminium, white / plastic, white
Rasterleuchte; Alu, weiss / Kunststoff, weiss
luminaire à grille; aluminium, blanc / plastique, blanc

L 595, B 595, H 11



33W 4700lm

96154 SALOBRENA 1

grid light; aluminium, white / plastic, white
Rasterleuchte; Alu, weiss / Kunststoff, weiss
luminaire à grille; aluminium, blanc / plastique, blanc

L 620, B 620, H 11



35W 4400lm



9 002759 961527

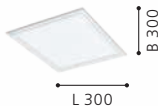

9 002759 961534

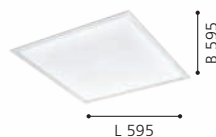

9 002759 961541

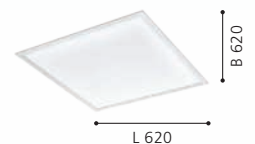



96151

LED

MOUNTING WITH INCLUDED MATERIAL

MONTAGE MIT INKLUDIERTEM MONTAGEMATERIAL

MONTAGE AVEC MATÉRIEL DE MONTAGE INCLUS

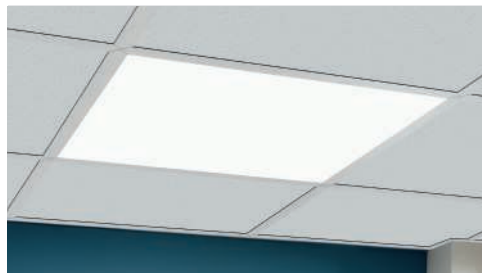

1 GRID LUMINAIRE
RASTERLEUCHTE
LUMINAIRE À GRILLE

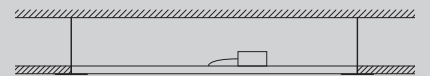

2 RECESSED LUMINAIRE
EINBAULEUCHTE
LUMINAIRE ENCASTRÉE



3 SEMI-RECESSED LUMINAIRE
SEMI-EINBAULEUCHTE
LUMINAIRE SEMI-ENCASTRÉE



4 SURFACE LUMINAIRE
AUFBAULEUCHTE
LUMINAIRE EN SAILLIE

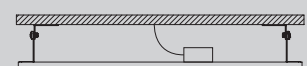

96151 SALOBRENA 1

grid light; aluminium, white / plastic, white
Rasterleuchte; Alu, weiss / Kunststoff, weiss
luminaire à grille; aluminium, blanc / plastique, blanc

L 1200, B 300, H 11

LED

33W

neutral
WHITE

4700lm

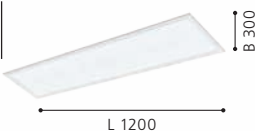



61489, 61355

Compatible with: / Kompatibel mit: / Compatible avec :
96151, 96152, 96153, 96154

61358

Compatible with: / Kompatibel mit: / Compatible avec :
96153

61359

Compatible with: / Kompatibel mit: / Compatible avec :
96154

61361

Compatible with: / Kompatibel mit: / Compatible avec :
96151

61489 SALOBRENA 1

accessory; steel, white
Zubehör; Stahl, weiss
Accessoires; acier, blanc

L 95, B 95, H 2000

61355 SALOBRENA 1

accessory; steel, chrome
Zubehör; Stahl, chrom
Accessoires; acier, chrome

L 900

61358 SALOBRENA 1

accessory; steel, white
Zubehör; Stahl, weiss
Accessoires; acier, blanc

L 603, B 603, H 50



9 002759 614898



9 002759 613556



9 002759 613587

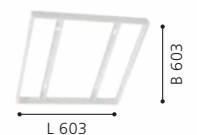



61361

61359

61358

OPTIONAL MOUNTING

OPTIONALE MONTAGE
MONTAGE OPTIONNEL



5 PENDANT LUMINAIRE HÄNGELEUCHT LUMINAIRE SUSPENSION

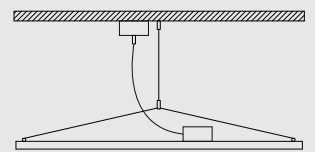

6 FRAME SURFACE LUMINAIRE RAHMEN AUFBAULEUCHT LUMINAIRE EN SAILLIE AVEC BOX

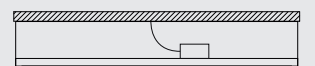

61359 SALOBRENA 1

accessory; steel, white
Zubehör; Stahl, weiss
Accessoires; acier, blanc

L 627, B 628, H 50



9 002759 613594

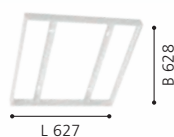

61361 SALOBRENA 1

accessory; steel, white
Zubehör; Stahl, weiss
Accessoires; acier, blanc

L 303, B 1205, H 50



9 002759 613617

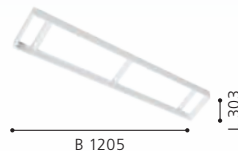



97501



97502



97503



97501 SARSINA

ceiling light; aluminium, white / plastic, white
Deckenleuchte; Alu, weiss / Kunststoff, weiss
plafonnier; aluminium, blanc / plastique, blanc

H 50, Ø 300



17W 2100lm

97502 SARSINA

ceiling light; aluminium, white / plastic, white
Deckenleuchte; Alu, weiss / Kunststoff, weiss
plafonnier; aluminium, blanc / plastique, blanc

H 50, Ø 450



28W 3800lm

97503 SARSINA

ceiling light; aluminium, white / plastic, white
Deckenleuchte; Alu, weiss / Kunststoff, weiss
plafonnier; aluminium, blanc / plastique, blanc

H 50, Ø 600



36W 5400lm



9 002759 975012

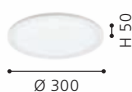

9 002759 975029

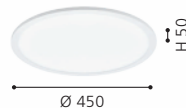

9 002759 975036

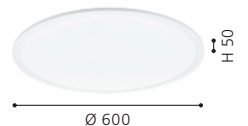



98207



98208



98209



98207 SARSINA-A

ceiling light; aluminium, white / plastic, white
Deckenleuchte; Alu, weiss / Kunststoff, weiss
plafonnier; aluminium, blanc / plastique, blanc

H 50, Ø 300



98208 SARSINA-A

ceiling light; aluminium, white / plastic, white
Deckenleuchte; Alu, weiss / Kunststoff, weiss
plafonnier; aluminium, blanc / plastique, blanc

H 50, Ø 450



98209 SARSINA-A

ceiling light; aluminium, white / plastic, white
Deckenleuchte; Alu, weiss / Kunststoff, weiss
plafonnier; aluminium, blanc / plastique, blanc

H 50, Ø 600



9 002759 982072

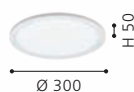

9 002759 982089

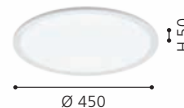

9 002759 982096

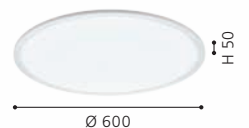



LED PANEL LUMINAIRES

FRAMELESS

ADVANTAGES

- > THE ENTIRE BODY OF THE PANEL IS UTILIZED AS LIGHT SOURCE
 - > ULTRA-FLAT DESIGN
 - > HOMOGENEOUS SURFACE LIGHTING
 - > SIMPLE AND FAST INSTALLATION
 - > ELEGANT SUSPENSION FRAME INCLUDED
 - > DECORATIVE DOMESTIC LIGHTING
 - > WALL AND CEILING LIGHTING
-

VORTEILE

- > DER GESAMTE LEUCHTKÖRPER DIENT ALS LEUCHTFLÄCHE
 - > ULTRAFLACHES DESIGN
 - > HOMOGENE LICHTVERTEILUNG
 - > EINFACHE UND SCHNELLE MONTAGE
 - > INKL. ELEGANTEM SCHWEBERAHMEN
 - > DEKORATIVE WOHNBELEUCHTUNG
 - > WAND- UND DECKENBELEUCHTUNG
-

AVANTAGES

- > LE CORPS ENTIER DU PANNEAU EST UTILISÉ COMME SOURCE DE LUMIÈRE
 - > DESIGN ULTRA PLAT
 - > ÉCLAIRAGE DE SURFACE HOMOGENÈNE
 - > MONTAGE SIMPLE ET RAPIDE
 - > BÂTI FLOTTANT ÉLÉGANT INCLUS
 - > ÉCLAIRAGE DOMESTIQUE DÉCORATIF
 - > ÉCLAIRAGE MURAL ET PLAFONNIER
- 

OVERVIEW

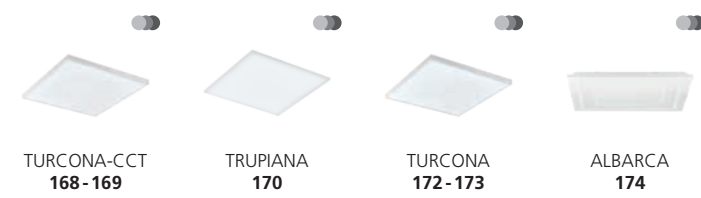

ACCESSORIES INCLUDED

All luminaires including Suspension frame
Alle Leuchten inklusive Schweberahmen
Tous les luminaires inclus bâti flottant



This product is available in different colors and shapes./ Dieser Artikel ist in unterschiedlichen Farben und Formen verfügbar./
Cet article est disponible en différentes couleurs et formes.



99833

LED

TURCONA - CCT

These luminaires have a backlight technology.

Diese Leuchten verfügen über eine Backlight Technology.

Ces luminaires sont équipés d'une technologie de retour.



99833

LED

incl./inkl./inclus



99833 TURCONA-CCT

ceiling light; aluminium, steel, white / plastic, white
 Deckenleuchte; Alu, Stahl, weiss / Kunststoff, weiss
 plafonnier; aluminium, acier, blanc / plastique, blanc

L 287, B 287, H 62



10,8W



1200lm



Remote

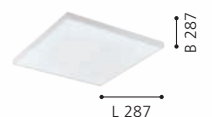



99834



99835



99836



99834 TURCONA-CCT

ceiling light; aluminium, steel, white / plastic, white
Deckenleuchte; Alu, Stahl, weiss / Kunststoff, weiss
plafonnier; aluminium, acier, blanc / plastique, blanc

L 437, B 437, H 70



21,6W



2600lm



Remote



99835 TURCONA-CCT

ceiling light; aluminium, steel, white / plastic, white
Deckenleuchte; Alu, Stahl, weiss / Kunststoff, weiss
plafonnier; aluminium, acier, blanc / plastique, blanc

L 587, B 587, H 70



32,4W



4000lm



Remote



99836 TURCONA-CCT

ceiling light; aluminium, steel, white / plastic, white
Deckenleuchte; Alu, Stahl, weiss / Kunststoff, weiss
plafonnier; aluminium, acier, blanc / plastique, blanc

L 1187, B 287, H 70



32,4W



3800lm



Remote



9 002759 998349



L 437

B 437



9 002759 998356



L 587

B 587



9 002759 998363



L 1187

B 287

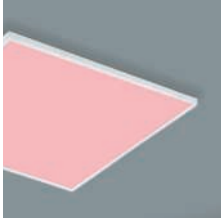

TRUPIANA

These luminaires have RGBTW function on the complete surface.

Diese Leuchten verfügen über eine RGBTW Funktion auf der kompletten Fläche.

Ces luminaires disposent d'une fonction RGBTW sur toute la surface.



900568



incl./inkl./inclus



900569



incl./inkl./inclus



900568 TRUPIANA

ceiling light; aluminium, steel, white / plastic, white
Deckenleuchte; Alu, Stahl, weiss / Kunststoff, weiss
plafonnier; aluminium, acier, blanc / plastique, blanc

L 437, B 437, H 62



20,5W



2900lm



Remote



9 008606 244706

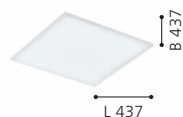

900569 TRUPIANA

ceiling light; aluminium, steel, white / plastic, white
Deckenleuchte; Alu, Stahl, weiss / Kunststoff, weiss
plafonnier; aluminium, acier, blanc / plastique, blanc

L 587, B 587, H 62



31 W



4200lm



Remote



9 008606 244713

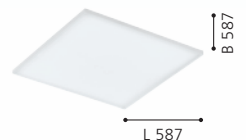



900569

LED





98901



98902



98903



TURCONA

These luminaires have an edgelight technology.

Diese Leuchten verfügen über eine Edgelight Technology.

Ces luminaires sont équipés d'une technologie edgelight.

98901 TURCONA

ceiling light; steel, white / plastic, satin finish
Deckenleuchte; Stahl, weiss / Kunststoff, satiniert
plafonnier; acier, blanc / plastique, satiné

L 300, B 300, H 60



11W 1500lm



9 002759 989019

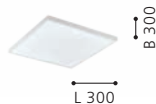

98902 TURCONA

ceiling light; steel, white / plastic, satin finish
Deckenleuchte; Stahl, weiss / Kunststoff, satiniert
plafonnier; acier, blanc / plastique, satiné

L 450, B 450, H 60



20W 2900lm



9 002759 989026

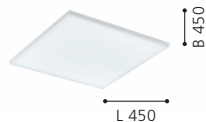

98903 TURCONA

ceiling light; steel, white / plastic, satin finish
Deckenleuchte; Stahl, weiss / Kunststoff, satiniert
plafonnier; acier, blanc / plastique, satiné

L 595, B 595, H 60



33W 4600lm



9 002759 989033

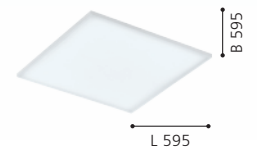



98904

LED



98905

LED

98904 TURCONA

ceiling light; steel, white / plastic, satin finish
Deckenleuchte; Stahl, weiss / Kunststoff, satiniert
plafonnier; acier, blanc / plastique, satiné

L 1200, B 300, H 60

LED

33W

neutral
WHITE

4600lm



98905 TURCONA

ceiling light; steel, white / plastic, satin finish
Deckenleuchte; Stahl, weiss / Kunststoff, satiniert
plafonnier; acier, blanc / plastique, satiné

L 1200, B 100, H 60

LED

19W

neutral
WHITE

3050lm



9 002759 989040



9 002759 989057





900959

LED

incl./inkl./inclus



900961

LED

incl./inkl./inclus



900959 ALBARCA

ceiling light; aluminium, steel, white / plastic, white
Deckenleuchte; Alu, Stahl, weiss / Kunststoff, weiss
plafonnier; aluminium, acier, blanc / plastique, blanc

L 438, B 438, H 69



18W



2400lm



Remote



900961 ALBARCA

ceiling light; aluminium, steel, white / plastic, white
Deckenleuchte; Alu, Stahl, weiss / Kunststoff, weiss
plafonnier; aluminium, acier, blanc / plastique, blanc

L 588, B 588, H 69



29W



4100lm



Remote



9 008606 277858



L 438

B 438



9 008606 277865



L 588

B 588

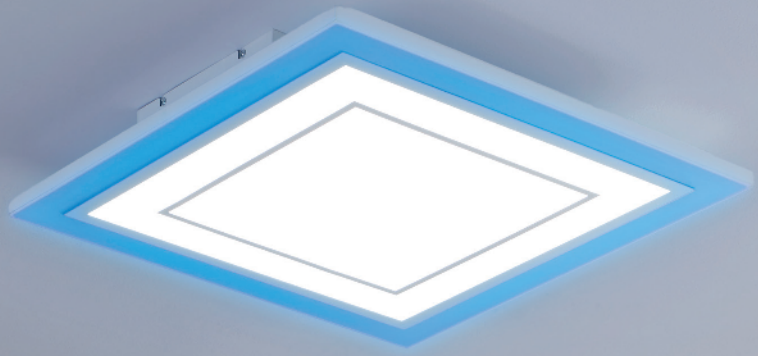

900961

LED



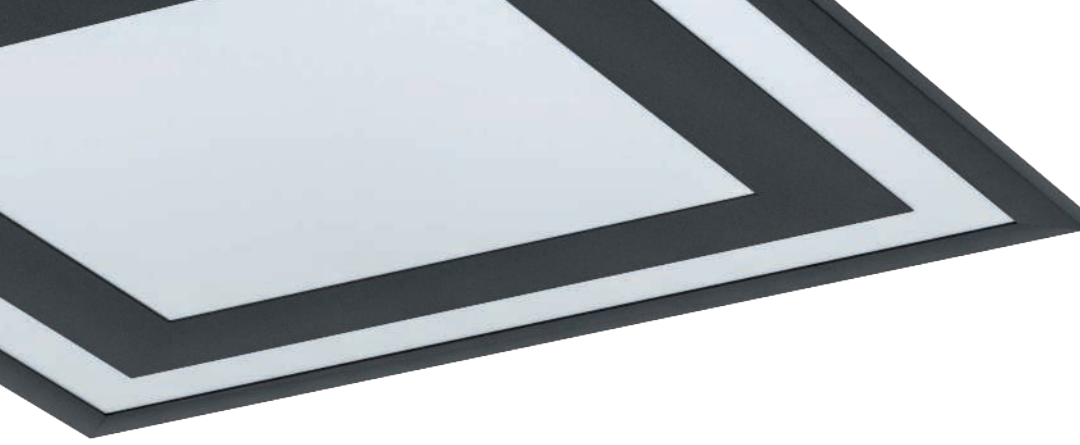

LED PANEL LUMINAIRES

DECORATIVE

ADVANTAGES

- > ULTRA-FLAT DESIGN
 - > HOMOGENEOUS SURFACE LIGHTING
 - > SIMPLE AND FAST INSTALLATION
 - > DECORATIVE DOMESTIC LIGHTING
 - > WALL AND CEILING LIGHTING
-

VORTEILE

- > ULTRAFLACHES DESIGN
 - > HOMOGENE LICHTVERTEILUNG
 - > EINFACHE UND SCHNELLE MONTAGE
 - > DEKORATIVE WOHNBELEUCHTUNG
 - > WAND- UND DECKENBELEUCHTUNG
-

AVANTAGES

- > DESIGN ULTRA PLAT
- > ÉCLAIRAGE DE SURFACE HOMOGENÈ
- > MONTAGE SIMPLE ET RAPIDE
- > ÉCLAIRAGE DOMESTIQUE DÉCORATIF
- > ÉCLAIRAGE MURAL ET PLAFONNIER

OVERVIEW



This product is available in different colors and shapes./ Dieser Artikel ist in unterschiedlichen Farben und Formen verfügbar/
Cet article est disponible en différentes couleurs et formes.



BORDONARA

These luminaires have a TW function on the entire surface and an additional RGB element.

Diese Leuchten verfügen über eine TW Funktion auf der gesamten Fläche und über ein zusätzliches RGB Element.

Ces luminaires disposent d'une fonction TW sur toute la surface et d'un élément RGB supplémentaire.



900571

LED

incl./inkl./inclus



900572

LED

incl./inkl./inclus



900573

LED

incl./inkl./inclus



900571 BORDONARA

ceiling light; aluminium, steel, black, white / plastic, white
Deckenleuchte; Alu, Stahl, schwarz, weiss / Kunststoff, weiss
plafonnier; aluminium, acier, noir, blanc / plastique, blanc

L 450, B 450



21,5W 2800lm

900572 BORDONARA

ceiling light; aluminium, steel, black, white / plastic, white
Deckenleuchte; Alu, Stahl, schwarz, weiss / Kunststoff, weiss
plafonnier; aluminium, acier, noir, blanc / plastique, blanc

L 595, B 595



36W 4900lm

900573 BORDONARA

ceiling light; aluminium, steel, black, white / plastic, white
Deckenleuchte; Alu, Stahl, schwarz, weiss / Kunststoff, weiss
plafonnier; aluminium, acier, noir, blanc / plastique, blanc

L 1195, B 295



35W 5400lm



9 008606 244720

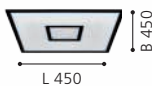

9 008606 244737



9 008606 244744





900571

LED





MARMORATA

Modus 1

Only the outer are glows/ Nur die äußere Fläche leuchtet/ Seule la surface extérieure brille

Modus 2

A "starry sky effect" is created in the central area/ Ein "Sternenhimmelleffekt" entsteht in den zentralen Fläche/ Un "effet de ciel étoilé" est créé dans la zone centrale

Modus 3

The outer area glows and a "starry sky effect" is created in the central area/ Die äußere Fläche leuchtet und ein "Sternenhimmelleffekt" entsteht in den zentralen Fläche/ La surface extérieure brille et un "effet de ciel étoilé" est créé dans la surface centrale



900558

LED

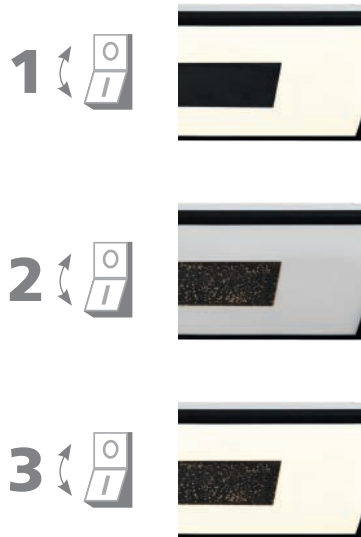

900559

LED

900558 MARMORATA

ceiling light; aluminium, steel, black, white / plastic, white
Deckenleuchte; Alu, Stahl, schwarz, weiss / Kunststoff, weiss
plafonnier; aluminium, acier, noir, blanc / plastique, blanc

H 70, Ø 450



900559 MARMORATA

ceiling light; aluminium, steel, black, white / plastic, white
Deckenleuchte; Alu, Stahl, schwarz, weiss / Kunststoff, weiss
plafonnier; aluminium, acier, noir, blanc / plastique, blanc

L 445, B 445



900561 MARMORATA

ceiling light; aluminium, steel, black, white / plastic, white
Deckenleuchte; Alu, Stahl, schwarz, weiss / Kunststoff, weiss
plafonnier; aluminium, acier, noir, blanc / plastique, blanc

L 595, B 295





900561

LED



900558

LED



901192

LED



901191

LED



incl./inkl./inclus



901191 BALAZOTE

ceiling light; steel, black / plastic, white
 Deckenleuchte; Stahl, schwarz / Kunststoff, weiss
 plafonnier; acier, noir / plastique, blanc

H 50, Ø 380

LED

26W

tunable
 WHITE

2300lm



CONTROL
 UNIT

Remote



9 008606 312702





REMOTE+

Our new 2.4 GHz REMOTE+ makes it easier than ever to control your luminaires. With its user-friendly design and simple control, you can easily adjust your luminaires to create the perfect ambiance for any occasion:

- › Stepless Dimming
- › Quick Pairing
- › Timer Function
- › Stepless Tunable White
- › Memory Effect
- › Control up to 10 REMOTE+ luminaires

Unsere neue 2,4-GHz REMOTE+ macht die Steuerung Ihrer Leuchten so einfach wie nie zuvor. Mit ihrem benutzerfreundlichen Design und der einfachen Steuerung können Sie Ihre Leuchten ganz einfach einstellen, um das perfekte Ambiente für jede Gelegenheit zu schaffen:

- › Stufenloses Dimmen
- › Schnelle Kopplung
- › Timer-Funktion
- › Stufenlos einstellbares Weiß
- › Memory-Effekt
- › Steuerung von bis zu 10 REMOTE+-Leuchten

Notre nouvelle REMOTE+ 2,4 GHz facilite plus que jamais le contrôle de vos lumières. Grâce à sa conception conviviale et à sa commande simple, vous pouvez facilement régler votre luminaires pour créer l'ambiance parfaite en toute occasion:

- › Gradation progressive
- › appairage rapide
- › Fonction de minuterie
- › Blanc réglable en continu
- › Effet de mémoire
- › Contrôle jusqu'à 10 luminaires REMOTE



901192



incl./inkl./inclus

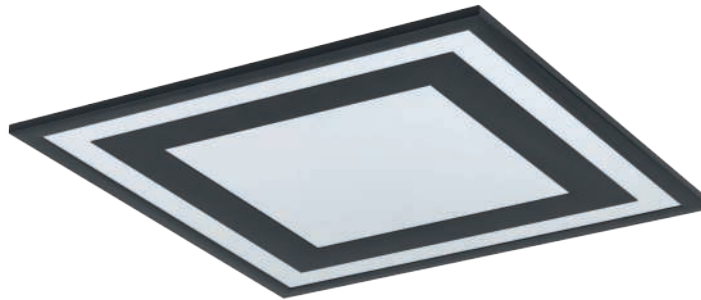

99038

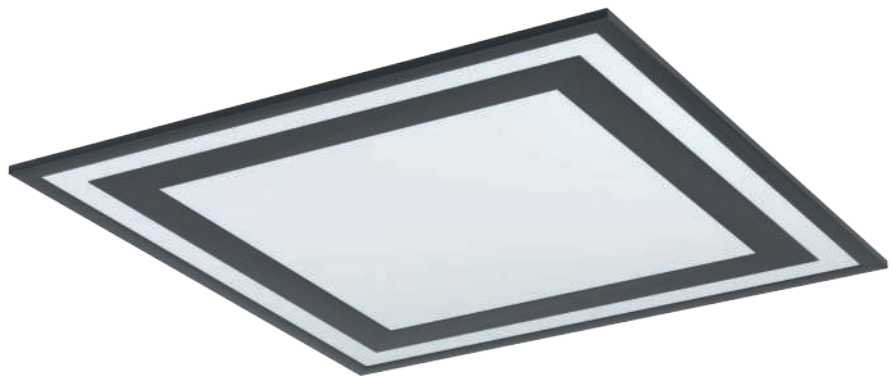

99039



901192 BALAZOTE

ceiling light; steel, black / plastic, white
Deckenleuchte; Stahl, schwarz / Kunststoff, weiss
plafonnier; acier, noir / plastique, blanc

L 360, B 360, H 50



26W



2300lm



Remote



99038 SAVATARILA

ceiling light; aluminium, black / plastic, white
Deckenleuchte; Alu, schwarz / Kunststoff, weiss
plafonnier; aluminium, noir / plastique, blanc

L 450, B 450, H 60



22,2W



2650lm



99039 SAVATARILA

ceiling light; aluminium, black / plastic, white
Deckenleuchte; Alu, schwarz / Kunststoff, weiss
plafonnier; aluminium, noir / plastique, blanc

L 595, B 595, H 60



32,5W



4000lm



9 008606 312719



L 360

B 360



9 002759 990381



L 450

B 450



9 002759 990398



L 595

B 595



99841

LED





99842



99841



99842 LAZARAS

ceiling light; aluminium, steel, white / plastic, white
 Deckenleuchte; Alu, Stahl, weiss / Kunststoff, weiss
 plafonnier; aluminium, acier, blanc / plastique, blanc

L 450, B 450, H 60



99841 LAZARAS

ceiling light; aluminium, steel, white / plastic, white
 Deckenleuchte; Alu, Stahl, weiss / Kunststoff, weiss
 plafonnier; aluminium, acier, blanc / plastique, blanc

H 55, Ø 450

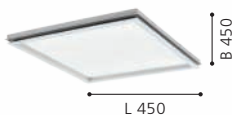



RECESSED DOWNLIGHTS

ADVANTAGES

- > DISCREET IN APPEARANCE, PERFECT IN STAGING
 - > SET THE SCENE IN YOUR HOME
 - > IMPRESS WITH THEIR UNCOMPLICATED APPLICATION
 - > ARE ENERGY AND COST-SAVING THANKS TO THE LED CIRCUIT BOARDS AND LED LIGHT SOURCES
-

VORTEILE

- > DEZENT IM AUFTRETEN, PERFEKT IN DER INSZENIERUNG
 - > SETZEN IHR ZUHAUSE IN SZENE
 - > ÜBERZEUGEN MIT IHRER UNKOMPLIZIERTEN ANWENDUNG
 - > SIND AUFGRUND DER LED-PLATINEN UND LED-LEUCHTMITTEL STROM- UND KOSTENSPAREND
-

AVANTAGES

- > DISCRET DANS SON APPARENCE, PARFAIT DANS SA MISE EN SCÈNE
- > METTENT VOTRE MAISON EN SCÈNE
- > CONVAINQUENT PAR LEUR SIMPLICITÉ D'UTILISATION
- > SONT ÉCONOMES EN ÉNERGIE ET EN COÛTS GRÂCE AUX PLATINES LED ET AUX SOURCES LUMINEUSES LED



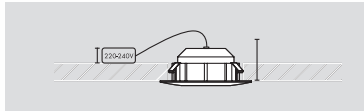

RECESSED DOWNLIGHTS

HIGH VOLTAGE

ADVANTAGES

- > LOW MOUNTING DEPTH
- > NO TRANSFORMER NECESSARY - THE LATEST LED HIGH-VOLTAGE TECHNOLOGY
- > IDEAL FOR LIGHTING OF ROOMS AND AREAS
- > PLEASANT WARM WHITE LIGHT COLOR
- > LOW TEMPERATURE ENHANCES SAFETY
- > UP TO 80% POWER SAVINGS COMPARED TO INCANDESCENT LAMPS, EASY ON YOUR BUDGET AND THE ENVIRONMENT
- > EASY AND SIMPLE WIRING BY 2-FOLD JUNCTION BOX - EASILY EXPANDABLE

VORTEILE

- > GERINGE EINBAUTIEFE
- > KEIN TRAFO MEHR NOTWENDIG – NEUESTE LED HOCHVOLT TECHNOLOGIE
- > IDEAL ZUR BELEUCHTUNG VON RÄUMEN UND FLÄCHEN
- > ANGENEHME WARM-WEISSE LICHTFARBE
- > GERINGE WÄRMEENTWICKLUNG SORGT FÜR MEHR SICHERHEIT
- > BIS ZU 80% STROMERSPARNIS GEGENÜBER GLÜHLAMPEN. SCHONT IHR BUDGET UND DIE UMWELT
- > EINFACHE UND SICHERE VERKABELUNG DURCH 2-FACH ANSCHLUSSBOX – UNKOMPLIZIERT ERWEITERBAR

AVANTAGES

- > FAIBLE PROFONDEUR DE MONTAGE
- > AUCUN TRANSFORMATEUR NÉCESSAIRE - LA DERNIÈRE TECHNOLOGIE À HAUTE TENSION LED
- > IDÉAL POUR L'ÉCLAIRAGE DES CHAMBRES ET DES ESPACES
- > AGRÉABLE COULEUR DE LUMIÈRE BLANCHE CHAUDE
- > FAIBLE CHALEUR AMÉLIORE LA SÉCURITÉ
- > JUSQU'À 80% D'ÉCONOMIES D'ÉNERGIE PAR RAPPORT AUX LAMPES À INCANDESCENCE. RÉDUIT VOTRE BUDGET ET PROTÈGE L'ENVIRONNEMENT
- > NOTRE BOÎTE DE DEUX JONCTIONS PERMET UN CÂBLAGE SIMPLE ET SÛRE. EN PLUS ELLE EST FACILEMENT EXTENSIBLE.

OVERVIEW



ARENALS
192



CALONGE
194-195



CALONGE RGB
196



PINEDA
198-202



SARTIANO
203



SALABATE
204



SALICETO
204-209



ZARATE
210



MECINOS
211



RAPITA
212-215



This product is available in different colors and shapes./ Dieser Artikel ist in unterschiedlichen Farben und Formen verfügbar./
Cet article est disponible en différentes couleurs et formes.



1 SIMPLE INSTALLATION!

Einfache Montage! / Montage simple !

Universally usable in walls or ceilings thanks to its small installation depth!

Durch die geringe Einbautiefe universell einsetzbar, ob Wand oder Decke!

Emploi universel dû à la faible profondeur de montage, que ce soit au mur ou au plafond !

2 QUICK AND SAFE CONNECTION!

Schnelles und sicheres Anschließen! /
Branchement rapide et sûr !

Easy wiring with the practical connection box!
No transformer is needed anymore thanks to
state of-the-art high-voltage technology!

Leichtes Verkabeln durch die praktische An-
schlussbox! Durch moderne Hochvolt-Technik
wird kein Trafo mehr benötigt!

Câbler simplement avec le boîtier de
branchement pratique ! Grâce à la technique de
haute tension moderne, plus besoin de transfor-
mateur !



3 PERFECT FIT!

Perfekter Halt! / Maintien parfait !

The integrated holding brackets permit simple
installation and guarantee for a precise fit!

Die integrierten Halteklammern ermöglichen
einen einfachen Einbau und sorgen für garantierte
Passgenauigkeit!

Les griffes de maintien intégrées permettent un
montage simple et assurent un parfait ajustement !





4

FLUSH INSTALLATION!

FLÄCHENBÜNDIGER EINBAU! / MONTAGE À FLEUR !

The slim build permits fitting installation in any surface!

Die schlanke Bauform ermöglicht den passenden Einbau bei jeder Fläche!

La structure fine permet le montage adéquat avec chaque surface !



ARENALS

Different colour rings included.

Verschiedene Farbringe enthalten.

Différents anneaux de couleur inclus.



901167

LED



901167 ARENALS

recessed light; aluminium, white / plastic, white

Einbauleuchte; Alu, weiss / Kunststoff, weiss

luminaire encastrable; aluminium, blanc / plastique, blanc

H 38, Ø 92

LED

1x 4,9W

warm
WHITE

550 lm



Ø 75



9 008606 315994



Ø 92



901167

LED





900915

LED



900912

LED



900914

LED

900912 CALONGE

recessed light; plastic, white
 Einbauleuchte; Kunststoff, weiss
 luminaire encastrable; plastique, blanc

Ø 100, A 45



LED

warm
WHITE
620lm

Ø 70

900914 CALONGE

recessed light; plastic, black, white
 Einbauleuchte; Kunststoff, schwarz, weiss
 luminaire encastrable; plastique, noir, blanc

Ø 100, A 45



LED

warm
WHITE
620lm

Ø 70



9 008606 277612



Ø 100



9 008606 277636



Ø 100

CALONGE

With memory function.

Mit Memory-Funktion.

Avec fonction mémoire.



900913

LED



900915

LED

900913 CALONGE

recessed light; plastic, white
Einbauleuchte; Kunststoff, weiss
luminaire encastrable; plastique, blanc

Ø 100, A 45

LED

3x 4,8W

warm
WHITE

1860lm



Ø 70



900915 CALONGE

recessed light; plastic, black, white
Einbauleuchte; Kunststoff, schwarz, weiss
luminaire encastrable; plastique, noir, blanc

Ø 100, A 45

LED

3x 4,8W

warm
WHITE

1860lm



Ø 70



9 008606 277629



Ø 100



9 008606 277643



Ø 100



DESIGN
HIGHLIGHT
DETAIL



901117



901118



901117 CALONGE RGB

recessed light; plastic, white
Einbauleuchte; Kunststoff, weiss
luminaire encastrable; plastique, blanc

H 32, Ø 98



3x 3,8W



3x 520lm



Ø 75



IP20/44



9 008606 297382



Ø 98

901118 CALONGE RGB

recessed light; plastic, black, white
Einbauleuchte; Kunststoff, schwarz, weiss
luminaire encastrable; plastique, noir, blanc

H 32, Ø 98



3x 3,8W



3x 520lm



Ø 75



IP20/44



9 008606 297399



Ø 98



901118



IP20/44





PINEDA
Ø 78, ET 35

recessed light
Einbauleuchte
luminaire encastrable



| Material / Colour | Size | Cutout | Quantity | Watt | Lumen | IP class | Item no. | EAN code |
|---|-------------|--------|----------|----------|--------|----------|---------------|-----------------|
| plastic, white Kunststoff, weiss plastique, blanc | Ø 78, ET 35 | Ø 65 | | 4,9W | 360lm | IP20/44 | 95817 | 9 002759 958176 |
| | Ø 78, ET 35 | Ø 65 | 3 | 3 x 4,9W | 1080lm | IP20/44 | 95821 | 9 002759 958213 |
| plastic, satin nickel Kunststoff, nickel-matt plastique, nickel mat | Ø 78, ET 35 | Ø 65 | | 4,9W | 360lm | IP20/44 | 95819 | 9 002759 958190 |
| | Ø 78, ET 35 | Ø 65 | 3 | 3 x 4,9W | 1080lm | IP20/44 | 95823 | 9 002759 958237 |
| plastic, chrome Kunststoff, chrom plastique, chrome | Ø 78, ET 35 | Ø 65 | | 4,9W | 360lm | IP20/44 | 95818 | 9 002759 958183 |
| | Ø 78, ET 35 | Ø 65 | 3 | 3 x 4,9W | 1080lm | IP20/44 | 95822 | 9 002759 958220 |
| plastic, black Kunststoff, schwarz plastique, noir | Ø 78, ET 35 | Ø 65 | | 4,9W | 360lm | IP20/44 | 900743 | 9 008606 253708 |
| | Ø 78, ET 35 | Ø 65 | 3 | 3 x 4,9W | 1080lm | IP20/44 | 900744 | 9 008606 253715 |













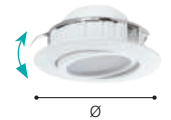

















PINEDA

Ø 84, ET 40

recessed light
Einbauleuchte
luminaire encastrable



| Material / Colour | Size | Cutout | Quantity | Watt | | Lumen | | Item no. | EAN code |
|---|-------------|--------|----------|----------|--|--------|---|---------------|-----------------|
|  plastic, white Kunststoff, weiss plastique, blanc | Ø 84, ET 40 | Ø 72 | 3 | 3 x 4,9W |  warm WHITE | 1080lm |  | 95851 | 9 002759 958510 |
| | Ø 84, ET 40 | Ø 72 | 3 | 3 x 5,5W |  warm WHITE | 1080lm |  | 95857 | 9 002759 958572 |
|  plastic, satin nickel Kunststoff, nickel-matt plastique, nickel mat | Ø 84, ET 40 | Ø 72 | 3 | 3 x 4,9W |  warm WHITE | 1080lm |  | 95853 | 9 002759 958534 |
| | Ø 84, ET 40 | Ø 72 | | 5,5W |  warm WHITE | 360lm |  | 95856 | 9 002759 958565 |
| | Ø 84, ET 40 | Ø 72 | 3 | 3 x 5,5W |  warm WHITE | 1080lm |  | 95859 | 9 002759 958596 |
|  plastic, chrome Kunststoff, chrom plastique, chrome | Ø 84, ET 40 | Ø 72 | 3 | 3 x 4,9W |  warm WHITE | 1080lm |  | 95852 | 9 002759 958527 |
| | Ø 84, ET 40 | Ø 72 | | 5,5W |  warm WHITE | 360lm |  | 95855 | 9 002759 958558 |
| | Ø 84, ET 40 | Ø 72 | 3 | 3 x 5,5W |  warm WHITE | 1080lm |  | 95858 | 9 002759 958589 |
|  plastic, black Kunststoff, schwarz plastique, noir | Ø 84, ET 40 | Ø 72 | | 5,5W |  warm WHITE | 360lm |  | 900748 | 9 008606 253753 |
| | Ø 84, ET 40 | Ø 72 | 3 | 3 x 5,5W |  warm WHITE | 1080lm |  | 900749 | 9 008606 253760 |



95843

LED



95844

LED



95846

LED



95843 PINEDA

recessed light; plastic, satin nickel
Einbauleuchte; Kunststoff, nickel-matt
luminaire encastrable; plastique, nickel mat

95846 PINEDA

recessed light; plastic, satin nickel
Einbauleuchte; Kunststoff, nickel-matt
luminaire encastrable; plastique, nickel mat

95844 PINEDA

recessed light; plastic, white
Einbauleuchte; Kunststoff, weiss
luminaire encastrable; plastique, blanc

L 84, B 84, ET 40



4,9W 360lm

Ø72

L 84, B 84, ET 40



3x 4,9W 1080lm

Ø72

L 84, B 84, ET 40



3x 4,9W 1080lm

Ø72



9 002759 958435



9 002759 958466



9 002759 958442





32896

LED

32896 SARTIANO

recessed light; plastic, white
 Einbauleuchte; Kunststoff, weiss
 luminaire encastrable; plastique, blanc

Ø 90, ET 45

LED

warm
WHITE



3x 4,6W 3x 500lm

Ø73



9 002759 328962



Ø 90



32896

LED



SALABATE

Ø 88, ET 52

recessed light
Einbauleuchte
luminaire encastrable



| Material / Colour | Size | Cutout | Watt | | Lumen | IP class | Item no. | EAN code |
|--|-------------|--------|------|---------------|-------|----------|--------------|-----------------|
| aluminium, white / glass, clear Alu, weiss / Glas, klar aluminium, blanc / verre, transparent | Ø 88, ET 52 | Ø 68 | 6W | warm WHITE | 380lm | IP20/44 | 98238 | 9 002759 982386 |
| | Ø 88, ET 52 | Ø 68 | 6W | neutral WHITE | 450lm | IP20/44 | 98241 | 9 002759 982416 |
| aluminium, black / glass, clear Alu, schwarz / Glas, klar aluminium, noir / verre, transparent | Ø 88, ET 52 | Ø 68 | 6W | warm WHITE | 380lm | IP20/44 | 99493 | 9 002759 994938 |
| | Ø 88, ET 52 | Ø 68 | 6W | neutral WHITE | 450lm | IP20/44 | 99494 | 9 002759 994945 |



SALICETO

H 42, Ø 88, ET 50

recessed light
Einbauleuchte
luminaire encastrable

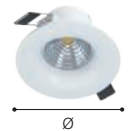

| Material / Colour | Size | Cutout | Watt | | Lumen | Item no. | EAN code |
|--|-------------------|--------|------|---------------|-------|--------------|-----------------|
| aluminium, white Alu, weiss aluminium, blanc | H 42, Ø 88, ET 50 | Ø 68 | 6W | warm WHITE | 380lm | 98243 | 9 002759 982430 |
| aluminium, satin nickel Alu, nickel-matt aluminium, nickel mat | H 42, Ø 88, ET 50 | Ø 68 | 6W | warm WHITE | 380lm | 98244 | 9 002759 982447 |
| aluminium, black Alu, schwarz aluminium, noir | H 42, Ø 88, ET 50 | Ø 68 | 6W | warm WHITE | 380lm | 98607 | 9 002759 986070 |
| | H 42, Ø 88, ET 50 | Ø 68 | 6W | neutral WHITE | 500lm | 33996 | 9 002759 339968 |



IP44



| | 0 | 1 | 2 | 3 |
|----|---|---|---|---|
| EU | X | X | ✓ | ✓ |
| FR | X | X | X | ✓ |

SALABETE

Water-splash protected luminaires are labelled with an IP value.

Spritzwassergeschützte Leuchten sind mittels IP-Wert gekennzeichnet.

Les luminaires protégés contre les projections d'eau sont identifiés au moyen de la valeur IP.



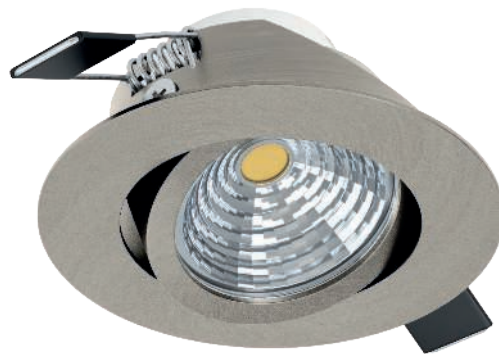

SALICETO

H 42, Ø 88, ET 50

recessed light
Einbauleuchte
luminaire encastrable

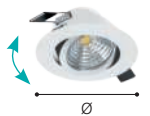

| Material / Colour | Size | Cutout | Quantity | Watt | Lumen | Item no. | EAN code |
|--|-------------------|--------|----------|--------|-------------------------|---------------|-----------------|
| aluminium, white Alu, weiss aluminium, blanc | H 42, Ø 88, ET 50 | Ø 68 | | 6W | warm WHITE 450lm | 98301 | 9 002759 983017 |
| | H 42, Ø 88, ET 50 | Ø 68 | 3 | 3 x 6W | warm WHITE 1350lm | 900745 | 9 008606 253722 |
| | H 42, Ø 88, ET 50 | Ø 68 | | 6W | neutral WHITE 500lm | 98305 | 9 002759 983055 |
| | H 42, Ø 88, ET 50 | Ø 68 | 3 | 3 x 6W | neutral WHITE 1350lm | 33391 | 9 002759 333911 |
| aluminium, satin nickel Alu, nickel-matt aluminium, nickel mat | H 42, Ø 88, ET 50 | Ø 68 | | 6W | warm WHITE 450lm | 98303 | 9 002759 983031 |
| | H 42, Ø 88, ET 50 | Ø 68 | 3 | 3 x 6W | warm WHITE 1350lm | 900746 | 9 008606 253739 |
| | H 42, Ø 88, ET 50 | Ø 68 | | 6W | neutral WHITE 500lm | 98307 | 9 002759 983079 |
| aluminium, black Alu, schwarz aluminium, noir | H 42, Ø 88, ET 50 | Ø 68 | | 6W | warm WHITE 380lm | 98609 | 9 002759 986094 |
| | H 42, Ø 88, ET 50 | Ø 68 | 3 | 3 x 6W | warm WHITE 1350lm | 900747 | 9 008606 253746 |
| | H 42, Ø 88, ET 50 | Ø 68 | | 6W | neutral WHITE 500lm | 33997 | 9 002759 339975 |



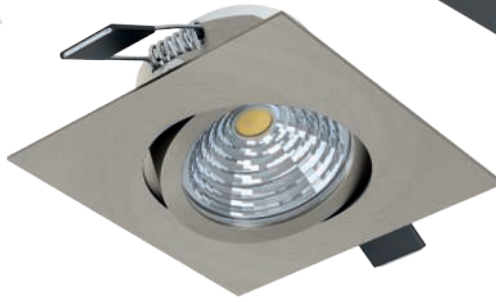

SALICETO

L 88, B 88, H 42, ET 50

recessed light
Einbauleuchte
luminaire encastrable

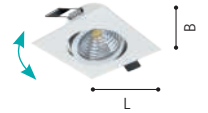

| Material / Colour | Size | Cutout | Watt | | Lumen | | Item no. | EAN code |
|--|-------------------------|--------|------|--|-------|--|--------------|-----------------|
| aluminium, white Alu, weiss aluminium, blanc | L 88, B 88, H 42, ET 50 | Ø 68 | 6W | | 450lm | | 98302 | 9 002759 983024 |
| | L 88, B 88, H 42, ET 50 | Ø 68 | 6W | | 500lm | | 98306 | 9 002759 983062 |
| aluminium, satin nickel Alu, nickel-matt aluminium, nickel mat | L 88, B 88, H 42, ET 50 | Ø 68 | 6W | | 450lm | | 98304 | 9 002759 983048 |
| | L 88, B 88, H 42, ET 50 | Ø 68 | 6W | | 500lm | | 98308 | 9 002759 983086 |
| aluminium, black Alu, schwarz aluminium, noir aluminium, black / glass, clear, white Alu, schwarz / Glas, klar, weiss aluminium, noir / verre, transparent, blanc | L 88, B 88, H 42, ET 50 | Ø 68 | 6W | | 380lm | | 98611 | 9 002759 986117 |
| | L 88, B 88, H 42, ET 50 | Ø 68 | 6W | | 450lm | | 33394 | 9 002759 333942 |



SALICETO

L 88, B 88, H 42, ET 50

recessed light
Einbauleuchte
luminaire encastrable

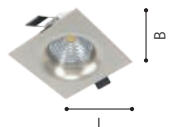

| Material / Colour | Size | Cutout | Watt | | Lumen | | Item no. | EAN code |
|---|-------------------------|--------|------|--|-------|--|--------------|-----------------|
| aluminium, satin nickel / glass, clear Alu, nickel-matt / Glas, klar aluminium, nickel mat / verre, transparent | L 88, B 88, H 42, ET 50 | Ø 68 | 6W | | 380lm | | 98472 | 9 002759 984724 |
| | L 88, B 88, H 42, ET 50 | Ø 68 | 6W | | 450lm | | 98474 | 9 002759 984748 |



96901

LED



900251

LED

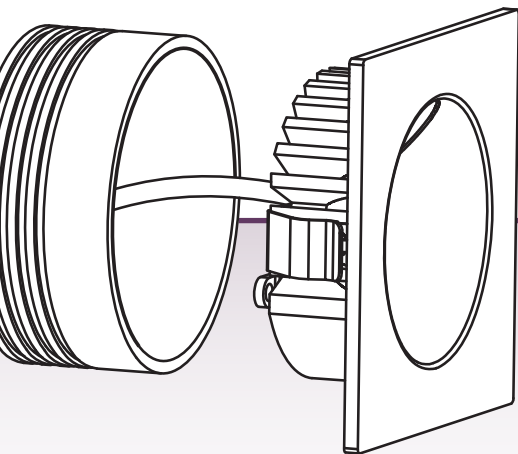

ZARATE, MECINOS

Including plaster ring.

Inklusive Einputzring.

Y compris l'anneau de plâtre.

96901 ZARATE

recessed light; cast aluminium, white / plastic, white
 Einbauleuchte; Aluguss, weiss / Kunststoff, weiss
 luminaire encastrable; fonte d'aluminium, blanc / plastique, blanc

L 80, B 80, ET 40



2W



90lm



Ø63

900251 ZARATE

recessed light; cast aluminium, black / plastic, white
 Einbauleuchte; Aluguss, schwarz / Kunststoff, weiss
 luminaire encastrable; fonte d'aluminium, noir / plastique, blanc

L 80, B 80, ET 40



2W



90lm



Ø63



9 002759 969011



L 80



9 008606 285778

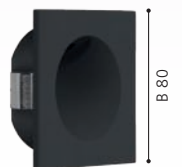

L 80



99643

LED



99644

LED



99644

LED



99643 MECINOS

recessed light; steel, white
 Einbauleuchte; Stahl, weiss
 luminaire encastrable; acier, blanc

L 80, B 80, H 3

LED

2W

warm
 WHITE

90lm



Ø68



9 002759 996437



L 80

B 80

99644 MECINOS

recessed light; steel, black
 Einbauleuchte; Stahl, schwarz
 luminaire encastrable; acier, noir

L 80, B 80, H 3

LED

2W

warm
 WHITE

90lm



Ø65



9 002759 996444



L 80

B 80



900965



IP20/65



900962



IP20/65

RAPITA



All sizes with installation diameter 68 mm.

Alle Größen mit Einbaudurchmesser 68 mm.

Toutes les tailles avec un diamètre d'installation de 68 mm.

900962 RAPITA

recessed light; aluminium, white / plastic, white

Einbauleuchte; Alu, weiss / Kunststoff, weiss

luminaire encastrable; aluminium, blanc / plastique, blanc

H 20, Ø 75



4,5W



600lm



Ø68



IP20/65



9 008606 275083



Ø 75



900963



IP20/65



900964



IP20/65



900965



IP20/65

900963 RAPITA

recessed light; aluminium, white / plastic, white
Einbauleuchte; Alu, weiss / Kunststoff, weiss
luminaire encastrable; aluminium, blanc / plastique, blanc

H 20, Ø 100



5,5W



750lm



Ø68



IP20/65



9 008606 275090



Ø 100

900964 RAPITA

recessed light; aluminium, white / plastic, white
Einbauleuchte; Alu, weiss / Kunststoff, weiss
luminaire encastrable; aluminium, blanc / plastique, blanc

H 20, Ø 155



11,5W



1550lm



Ø68



IP20/65



9 008606 275106



Ø 155

900965 RAPITA

recessed light; aluminium, white / plastic, white
Einbauleuchte; Alu, weiss / Kunststoff, weiss
luminaire encastrable; aluminium, blanc / plastique, blanc

H 20, Ø 215



18W



2400lm



Ø68



IP20/65



9 008606 275113



Ø 215

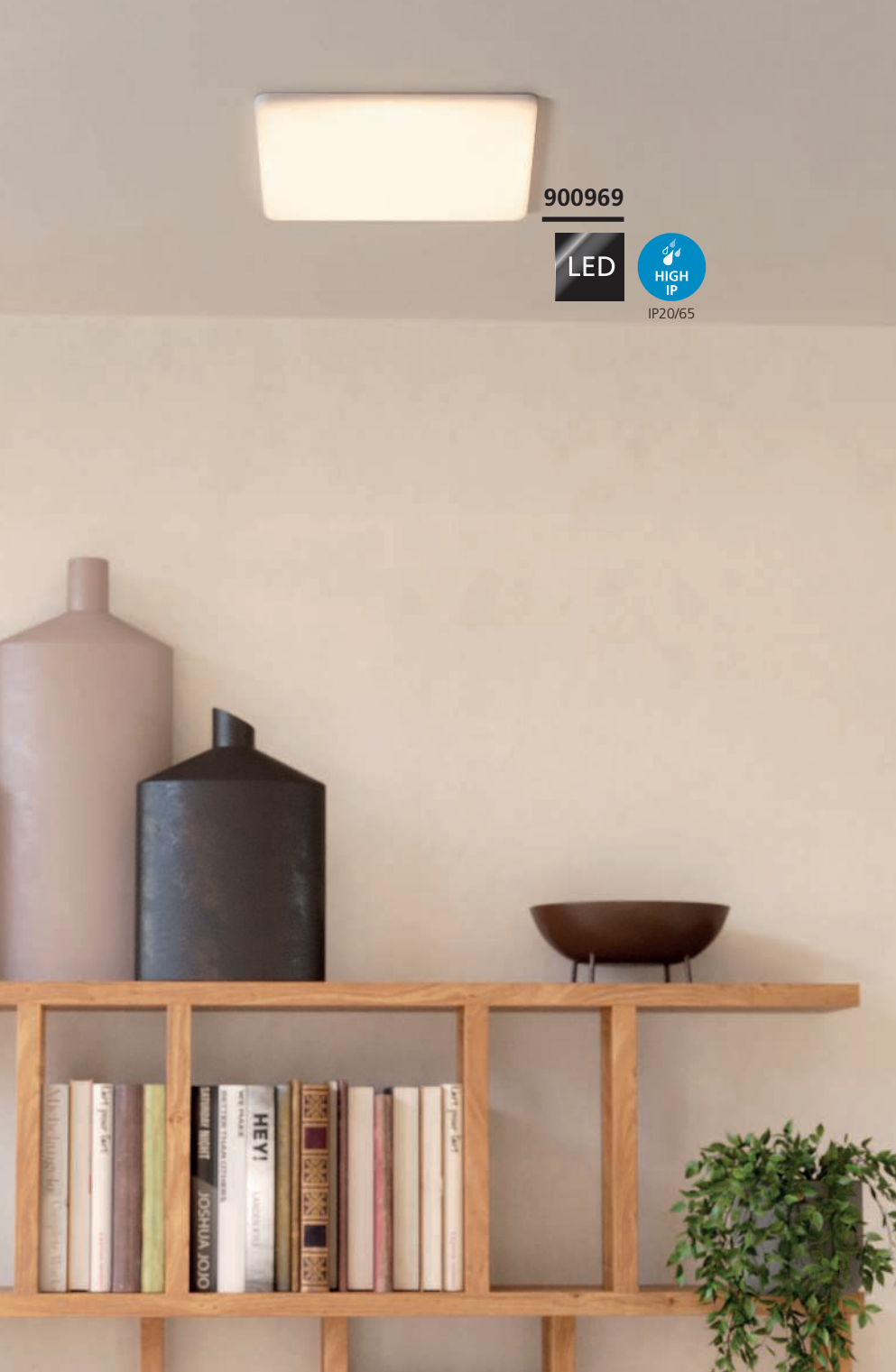

900969



IP20/65



900966



IP20/65

RAPITA



All sizes with installation diameter 68 mm.

Alle Größen mit Einbaudurchmesser 68 mm.

Toutes les tailles avec un diamètre d'installation de 68 mm.

900966 RAPITA

recessed light; aluminium, white / plastic, white

Einbauleuchte; Alu, weiss / Kunststoff, weiss

luminaire encastrable; aluminium, blanc / plastique, blanc

L 75, B 75, H 20



4,5W



600lm



Ø68



IP20/65



9 008606 275 120





900967



IP20/65

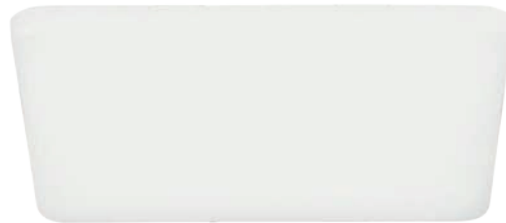

900968



IP20/65

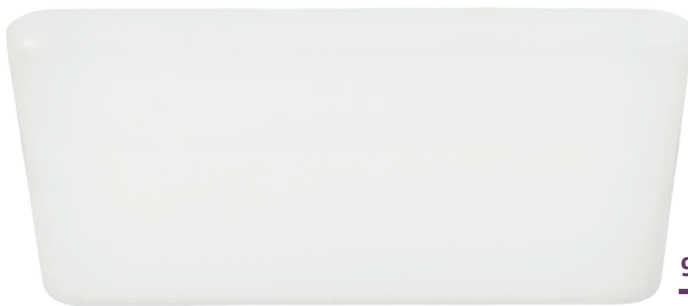

900969



IP20/65

900967 RAPITA

recessed light; aluminium, white / plastic, white
Einbauleuchte; Alu, weiss / Kunststoff, weiss
luminaire encastrable; aluminium, blanc / plastique, blanc

L 100, B 100, H 20



5,5W



750lm



Ø68



IP20/65



9 008606 275137



L 100

B 100

900968 RAPITA

recessed light; aluminium, white / plastic, white
Einbauleuchte; Alu, weiss / Kunststoff, weiss
luminaire encastrable; aluminium, blanc / plastique, blanc

L 155, B 155, H 20



11,5W



1550lm



Ø68



IP20/65



9 008606 275144



L 155

B 155

900969 RAPITA

recessed light; aluminium, white / plastic, white
Einbauleuchte; Alu, weiss / Kunststoff, weiss
luminaire encastrable; aluminium, blanc / plastique, blanc

L 215, B 215, H 20



18W



2400lm



Ø68



IP20/65



9 008606 275151

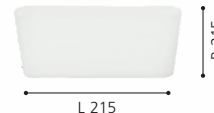

L 215

B 215



RECESSED DOWNLIGHTS

LOW VOLTAGE

ADVANTAGES

- > SLIM DESIGN WITH MINIMAL INSTALLATION DEPTH, MAKING IT IDEAL FOR CEILING STRUCTURES WITH LITTLE SPACE
 - > UNIFORM DISTRIBUTION OF LIGHT - IDEAL FOR ILLUMINATING SPACES AND SURFACES
 - > LOW TEMPERATURE ENHANCES SAFETY
 - > UP TO 80% POWER SAVINGS COMPARED TO INCANDESCENT LAMPS, EASY ON YOUR BUDGET AND THE ENVIRONMENT
 - > IMPL. CABLING THROUGH INTEGRATED TERMINAL CONNECTOR ON DRIVER
-

VORTEILE

- > SCHLANKE BAUFORM MIT MINIMALER EINBAUTIEFE, DAHER IDEAL FÜR DECKEN-KONSTRUKTIONEN MIT WENIG PLATZ
 - > HOMOGENE LICHTVERTEILUNG - IDEAL ZUR BELEUCHTUNG VON RÄUMEN UND FLÄCHEN
 - > GERINGE WÄRMEENTWICKLUNG SORGT FÜR MEHR SICHERHEIT
 - > BIS ZU 80% STROMERSPARNIS GEGENÜBER GLÜHLAMPEN, SCHONT IHR BUDGET UND DIE UMWELT
 - > EINFACHE VERKABELUNG DURCH INTEGRIERTEN KLEMMANSCHLUSS AM TREIBER
-

AVANTAGES

- > CONCEPTION MINCE AVEC LA PROFONDEUR D'INSTALLATION MINIMALE, IDÉAL POUR LES STRUCTURES DE PLAFOND AVEC PEU D'ESPACE
- > DISTRIBUTION UNIFORME DE LA LUMIÈRE - IDÉAL POUR L'ILLUMINATION DES ESPACES ET SURFACES
- > FAIBLE CHALEUR AMÉLIORE LA SÉCURITÉ
- > JUSQU'À 80% D'ÉCONOMIES D'ÉNERGIE PAR RAPPORT AUX LAMPES À INCANDESCENCE, RÉDUIT VOTRE BUDGET ET PROTÈGE L'ENVIRONNEMENT
- > CÂBLAGE SIMPLE VIA LE CONNECTEUR DE TERMINAL INTÉGRÉ SUR CONDUCTEUR

OVERVIEW



CHANGO
218



This product is available in different colors and shapes./ Dieser Artikel ist in unterschiedlichen Farben und Formen verfügbar./
Cet article est disponible en différentes couleurs et formes.



97079



IP44

CHANGO

- | | | |
|--|---|--|
| <ul style="list-style-type: none"> > "Starry Sky" 3 Spot Set > Simple installation > Pre-assembled connecting box > Plug & Play > Desktop driver > Operable with 2 – 3 spotheads incl. short-connector > Cable length = 2 m > Cutout dimension = 16 mm | <ul style="list-style-type: none"> > "Sternenhimmel" 3 Spot Set > Einfache Montage > Vorkonfigurierte Anschlußbox > Plug & Play > Desktop Treiber > Verwendbar mit 2 – 3 Spotköpfen inkl. Verbinder > Kabellänge = 2 m > Ausschnitt Durchmesser = 16 mm | <ul style="list-style-type: none"> > Ensemble 3 spots "Ciel étoilé " > Installation simple > Boîte de connexion pré-assemblée > Branchez & jouez > Pilote de bureau > Utilisable avec 2 à 3 têtes incl. connecteur court > Longueur du câble = 2 m > Cote de découpe = 16 mm |
|--|---|--|

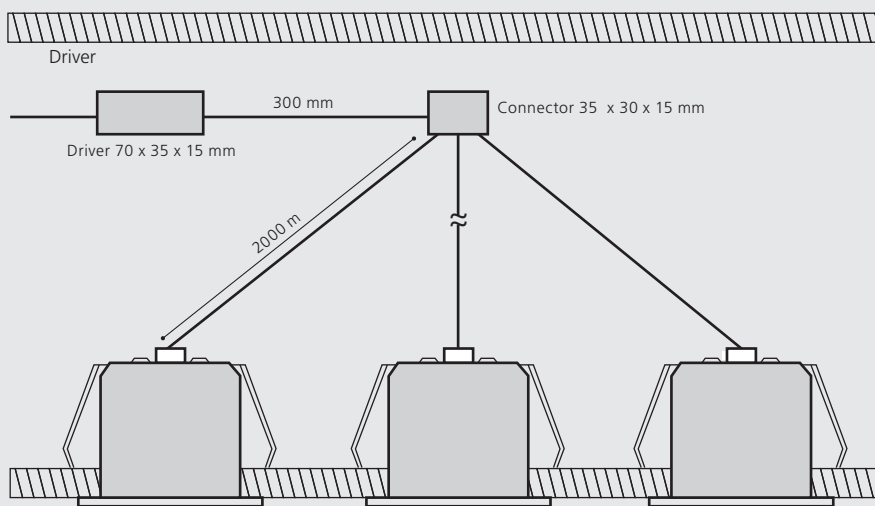

97079 CHANGO

recessed light; aluminium, white
 Einbauleuchte; Alu, weiss
 luminaire encastrable; aluminium, blanc

H 22, Ø 32, ET 25



3x 1 W



300 lm



Ø 15



IP44



9 002759 970796



Ø 32



97079

LED



IP44

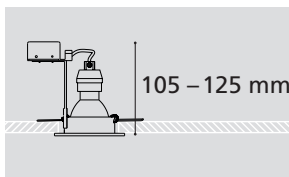

RECESSED DOWNLIGHTS

WITH SOCKET

ADVANTAGES

- > PROVEN TECHNOLOGY, CUSTOMIZED SOLUTIONS IN EVERY PRICE CATEGORY
- > DEPENDING ON THE SELECTED LAMPS APPROPRIATE FOR ILLUMINATING AREAS AND ROOMS OR FOR ACCENT LIGHTING
- > GREAT COLORS AND SHAPES
- > UP TO 80% POWER SAVINGS COMPARED TO INCANDESCENT LAMPS, EASY ON YOUR BUDGET AND THE ENVIRONMENT
- > LAMP REPLACEABLE FROM THE BOTTOM

VORTEILE

- > BEWÄHRTE TECHNOLOGIE, INDIVIDUELLE LÖSUNGEN IN JEDER PREISKLASSE
- > JE NACH EINGESETZTEM LEUCHTMITTEL ZUR BELEUCHTUNG VON FLÄCHEN UND RÄUMEN ODER ZUR AKZENTBELEUCHTUNG
- > GROSSE FARBEN- UND FORMENVIELFALT
- > BIS ZU 80% STROMERSPARNIS GEGENÜBER GLÜHLAMPEN, SCHONT IHR BUDGET UND DIE UMWELT
- > LEUCHTMITTEL VON UNTEN TAUSCHBAR

AVANTAGES

- > UNE TECHNOLOGIE ÉPROUVÉE, SOLUTIONS INDIVIDUELLES DANS CHAQUE CATÉGORIE DE PRIX
- > SELON LES LAMPES CHOISIES APTÉ À ÉCLAIRER DES SURFACES ET DES CHAMBRES OU POUR L'ÉCLAIRAGE ACCENTUEL
- > COULEURS ET FORMES FANTASTIQUES
- > JUSQU'À 80% D'ÉCONOMIES D'ÉNERGIE PAR RAPPORT AUX LAMPES À INCANDESCENCE, RÉDUIT VOTRE BUDGET ET PROTÈGE L'ENVIRONNEMENT
- > LAMPE REMPLAÇABLE PAR LE BAS

OVERVIEW



AREITIO
222



FAVAZZINA
224-225



PENETO
226-231



TEDO
232



TEDO 1
233



CAROSSO
234-237



This product is available in different colors and shapes./ Dieser Artikel ist in unterschiedlichen Farben und Formen verfügbar./
Cet article est disponible en différentes couleurs et formes.



98639

LED



98637

LED

98639 AREITIO

recessed light; aluminium, brushed aluminium
 Einbauleuchte; Alu, alu-gebürstet
 luminaire encastrable; aluminium, aluminium brossé

Ø 100, ET 115



GU10 3x 4,6W
 warm
 WHITE 3x
 400lm Ø79

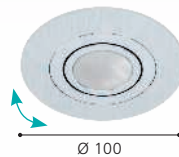

98637 AREITIO

recessed light; aluminium, brushed aluminium
 Einbauleuchte; Alu, alu-gebürstet
 luminaire encastrable; aluminium, aluminium brossé

L 95, B 95, ET 115



GU10 3x 4,6W
 warm
 WHITE 3x
 400lm Ø75

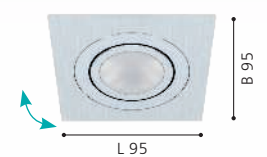



98639

LED





901756

LED



901755

LED



901757

LED

901756 FAVAZZINA

recessed light; steel, white
 Einbauleuchte; Stahl, weiss
 luminaire encastrable; acier, blanc

901757 FAVAZZINA

recessed light; steel, satin nickel
 Einbauleuchte; Stahl, nickel-matt
 luminaire encastrable; acier, nickel mat

901755 FAVAZZINA

recessed light; steel, black
 Einbauleuchte; Stahl, schwarz
 luminaire encastrable; acier, noir

Ø 88, ET 65



Ø 88, ET 65



Ø 88, ET 65

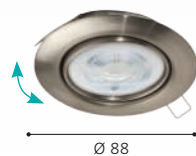
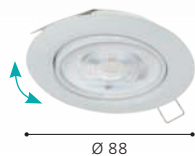



901759

LED



IP44



FAVAZZINA

Low installation depth despite GU10 socket thanks to the new light source with low profile. Bulb 110351 is included in the scope of delivery.

Niedrige Einbautiefe trotz GU10-Fassung dank des neuen Leuchtmittels mit niedrigem Profil. Leuchtmittel 110351 ist im Lieferumfang enthalten.

Faible profondeur d'installation malgré la douille GU10 grâce à la nouvelle source lumineuse à profil bas. L'ampoule 110351 est incluse dans la livraison.



901761

LED



IP44



901758

LED



IP44

901759 FAVAZZINA

recessed light; steel, white / glass, clear
 Einbauleuchte; Stahl, weiss / Glas, klar
 luminaire encastrable; acier, blanc / verre, transparent

901761 FAVAZZINA

recessed light; steel, satin nickel / glass, clear
 Einbauleuchte; Stahl, nickel-matt / Glas, klar
 luminaire encastrable; acier, nickel mat / verre, transparent

901758 FAVAZZINA

recessed light; steel, black / glass, clear
 Einbauleuchte; Stahl, schwarz / Glas, klar
 luminaire encastrable; acier, noir / verre, transparent

Ø 85, ET 70

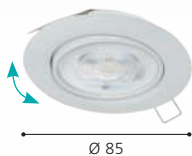

Ø 85, ET 70

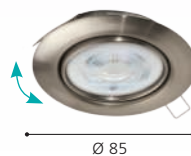

Ø 85, ET 70





94235 PENETO

recessed light; steel, white
 Einbauleuchte; Stahl, weiss
 luminaire encastrable; acier, blanc

94236 PENETO

recessed light; steel, chrome
 Einbauleuchte; Stahl, chrom
 luminaire encastrable; acier, chrome

94237 PENETO

recessed light; steel, satin nickel
 Einbauleuchte; Stahl, nickel-matt
 luminaire encastrable; acier, nickel matt

Ø 78, ET 115



Ø 78, ET 115

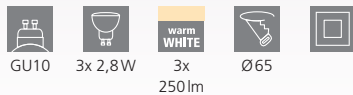

Ø 78, ET 115

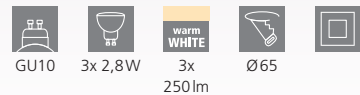



900753

LED



900754

LED



900753 PENETO

recessed light; steel, black
Einbauleuchte; Stahl, schwarz
luminaire encastrable; acier, noir

Ø 78, ET 115



GU10



1x 2,8W



warm
WHITE

1x
250lm



Ø65



Ø78

900754 PENETO

recessed light; steel, black
Einbauleuchte; Stahl, schwarz
luminaire encastrable; acier, noir

Ø 78, ET 115



GU10



3x 2,8W



warm
WHITE

3x
250lm



Ø65



Ø78



9 008606 253852



Ø 78



9 008606 253869

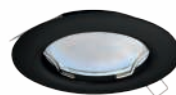

Ø 78



900751

LED



94239

LED



94242

LED

900751 PENETO

recessed light; steel, black
Einbauleuchte; Stahl, schwarz
luminaire encastrable; acier, noir

94239 PENETO

recessed light; steel, white
Einbauleuchte; Stahl, weiss
luminaire encastrable; acier, blanc

94242 PENETO

recessed light; steel, satin nickel
Einbauleuchte; Stahl, nickel-matt
luminaire encastrable; acier, nickel mat

Ø 87, ET 115



Ø 87, ET 115



Ø 87, ET 115



Ø 87



Ø 87



Ø 87



900752

LED

900752 PENETO

recessed light; steel, black
 Einbauleuchte; Stahl, schwarz
 luminaire encastrable; acier, noir

Ø 87, ET 115



GU10



3x 4,6W



warm
 WHITE
 3x
 400lm



Ø 70

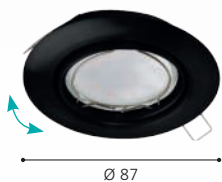

900751

LED





94406

LED





94406

LED



94407

LED



94408

LED

94406 PENETO

recessed light; steel, white
 Einbauleuchte; Stahl, weiss
 luminaire encastrable; acier, blanc

Ø 87, ET 115

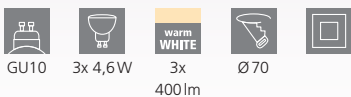

GU10 3x 4,6W 3x 400lm Ø 70



9 002759 944063

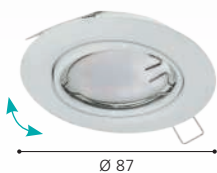

94407 PENETO

recessed light; steel, chrome
 Einbauleuchte; Stahl, chrom
 luminaire encastrable; acier, chrome

Ø 87, ET 115



GU10 3x 4,6W 3x 400lm Ø 70



9 002759 944070

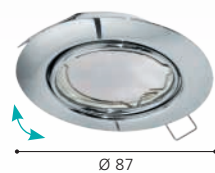

94408 PENETO

recessed light; steel, satin nickel
 Einbauleuchte; Stahl, nickel-matt
 luminaire encastrable; acier, nickel mat

Ø 87, ET 115



GU10 3x 4,6W 3x 400lm Ø 70



9 002759 944087

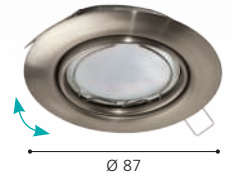



95359

LED



31683

LED



31689

LED

31683 TEDO

recessed light; cast aluminium, white
 Einbauleuchte; Aluguss, weiss
 luminaire encastrable; fonte d'aluminium, blanc

31689 TEDO

recessed light; cast aluminium, satin nickel
 Einbauleuchte; Aluguss, nickel-matt
 luminaire encastrable; fonte d'aluminium, nickel mat

Ø 80, ET 115



Ø 80, ET 115





95359

LED

95359 TEDO 1

recessed light; cast aluminium, satin nickel

Einbauleuchte; Aluguss, nickel-matt

luminaire encastrable; fonte d'aluminium, nickel mat

Ø 80, ET 115



GU10



3x 4,8W



warm
WHITE

3x
400lm



Ø68



9 002759 953591



Ø 80

1



2



3



DIMMING WITHOUT A DIMMER?

There's no need for a dimmer anymore, and no need to spend money on an expensive modern LED-capable one.

The luminaire automatically switches to the next dimming level when it is switched off and on again within 3 seconds. If the luminaire stays off for more than 3 seconds, the next activation will automatically return to full lighting. You don't need to switch through all levels the next day.

Note

Our step dimming illuminants are only dimmable via the on/off switch. Operation with a conventional dimmer is not intended and may cause permanent damage to the electronics. The illuminants are therefore marked as "not dimmable" according to European regulations.

DIMMEN OHNE DIMMER?

Kein Dimmer mehr notwendig – Sie ersparen sich somit hohe Anschaffungskosten für einen modernen LED-fähigen Dimmer.

Werden die Leuchten innerhalb von 3 Sekunden aus- und wieder eingeschaltet, wechselt es automatisch in die nächste Dimmstufe. Bleibt die Leuchte länger als 3 Sekunden ausgeschaltet, stehen Ihnen beim nächsten Einschalten automatisch wieder 100 % Leuchtkraft zur Verfügung – Sie ersparen sich also das mühsame Durchschalten am nächsten Tag.

Hinweis

Unsere Stepdimming-Leuchtmittel sind nur über Ein-/Ausshalter dimmbar – der Betrieb mit konventionellen Dimmern ist nicht vorgesehen und könnte die Elektronik dauerhaft beschädigen. Die Leuchtmittel werden daher gemäß europäischer Vorschriften als „nicht dimmbar“ gekennzeichnet.

GRADUER SANS GRADUATEUR ?

Aucun graduateur n'est nécessaire – Vous vous épargnez ainsi les coûts d'acquisition élevés pour un graduateur DEL moderne.

Si les luminaires sont éteints puis rallumés en l'espace de 3 secondes, il passe automatiquement au niveau de gradation suivant. Si le luminaire reste éteint pendant plus de 3 secondes, vous disposez à nouveau automatiquement de 100 % d'intensité lumineuse lors du prochain allumage - vous vous épargnez ainsi la tâche fastidieuse d'allumer le luminaire le lendemain.

Remarque

Nos ampoules à gradation par niveau sont graduable uniquement par l'interrupteur marche / arrêt – le service avec un graduateur conventionnel n'est pas prévu et pourrait endommager l'électronique à long terme. Les ampoules sont alors marquées par « non graduable », selon les réglementations européenne.

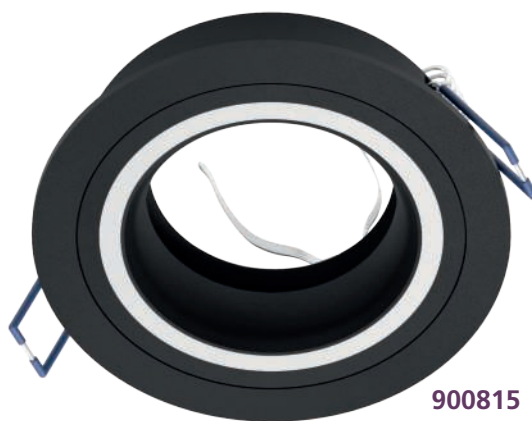

900815 CAROSSO

recessed light; aluminium, black, white
Einbauleuchte; Alu, schwarz, weiss
luminaire encastrable; aluminium, noir, blanc

H 28, Ø 93



GU10



1x 35W



Ø80



9 008606 259236



Ø 93



900816



900454

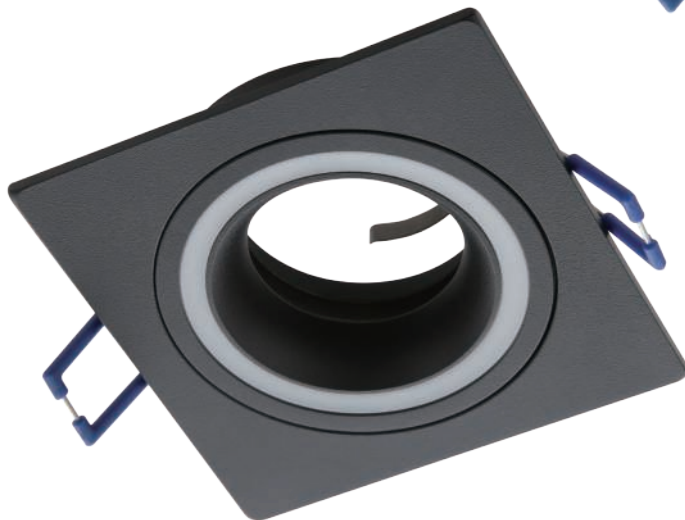

900451

900451 CAROSSO

recessed light; aluminium, black / plastic, white
 Einbauleuchte; Alu, schwarz / Kunststoff, weiss
 luminaire encastrable; aluminium, noir / plastique, blanc

L 93, B 93, H 25



900816 CAROSSO

recessed light; aluminium, white
 Einbauleuchte; Alu, weiss
 luminaire encastrable; aluminium, blanc

H 28, Ø 93



900454 CAROSSO

recessed light; aluminium, white / plastic, white
 Einbauleuchte; Alu, weiss / Kunststoff, weiss
 luminaire encastrable; aluminium, blanc / plastique, blanc

L 93, B 93, H 25

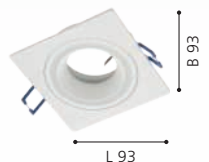
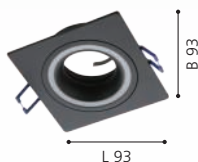



900453 CAROSSO

recessed light; aluminium, black, white
 Einbauleuchte; Alu, schwarz, weiss
 luminaire encastrable; aluminium, noir, blanc

H 35, Ø 93



GU10 1x 35W Ø68



Ø 93

900452 CAROSSO

recessed light; aluminium, black, white
 Einbauleuchte; Alu, schwarz, weiss
 luminaire encastrable; aluminium, noir, blanc

L 93, B 93, H 25



GU10 1x 35W Ø68

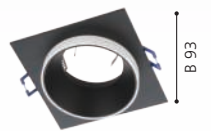

L 93



900456 CAROSSO

recessed light; aluminium, white, black
 Einbauleuchte; Alu, weiss, schwarz
 luminaire encastrable; aluminium, blanc, noir

H 35, Ø 93



GU10 1x 35W Ø68

900455 CAROSSO

recessed light; aluminium, white, black
 Einbauleuchte; Alu, weiss, schwarz
 luminaire encastrable; aluminium, blanc, noir

L 93, B 93, H 25



GU10 1x 35W Ø68

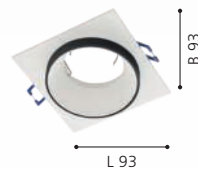

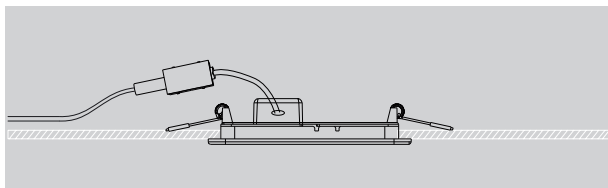

RECESSED DOWNLIGHTS

FUEVA

ADVANTAGES

- > MODERN APPEARANCE - THE FUEVA CONVINCES WITH ITS FLAT DESIGN AND NARROW FRAME
 - > AVAILABLE IN DIFFERENT VARIATIONS (MATERIAL & COLOUR, SHAPE, IP CLASS)
 - > INCLUSIVE PLUG-IN TERMINAL - FOR QUICK WORK AND EASY HANDLING
-

VORTEILE

- > MODERNES ERSCHEINUNGSBILD - DIE FUEVA ÜBERZEUGT DURCH IHR FLACHES DESIGN SOWIE DEN SCHMALEN RAHMEN
 - > ERHÄLTlich IN VERSCHIEDENEN VARIATIONEN (FARBE, FORM, IP KLASSE)
 - > INKLUSIVE STECKKLEMME - FÜR DAS SCHNELLE ARBEITEN UND EINE EINFACHE HANDHABUNG
-

AVANTAGES

- > APPARENCE MODERNE - LE FUEVA CONVAINC PAR SON DESIGN PLAT ET SON CADRE ÉTROIT
- > DISPONIBLE EN DIFFÉRENTES VARIATIONS (COULEUR, FORME, CLASSE IP)
- > Y COMPRIS UNE BORNE ENFICHABLE - POUR UN TRAVAIL RAPIDE ET UNE MANIPULATION SIMPLE

OVERVIEW



FUEVA 5
241-251



FUEVA-A
242



FUEVA 1
252



FUEVA FLEX
255



This product is available in different colors and shapes./ Dieser Artikel ist in unterschiedlichen Farben und Formen verfügbar./
Cet article est disponible en différentes couleurs et formes.



IP44



| | 0 | 1 | 2 | 3 |
|----|---|---|---|---|
| EU | X | X | ✓ | ✓ |
| FR | X | X | X | ✓ |

FUEVA 5

Water-splash protected luminaires are labelled with an IP value.

Spritzwassergeschützte Leuchten sind mittels IP-Wert gekennzeichnet.

Les luminaires protégés contre les projections d'eau sont identifiés au moyen de la valeur IP.









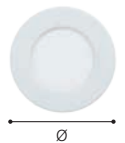



























FUEVA 5

Ø 86, ET 26

recessed light
Einbauleuchte
luminaire encastrable



| Material / Colour | Size | Cutout | Quantity | Watt | Lumen | IP class | Item no. | EAN code |
|--|-------------|--------|----------|----------|---|--|--------------|-----------------|
|  steel, white / plastic, white Stahl, weiss / Kunststoff, weiss acier, blanc / plastique, blanc | Ø 86, ET 26 | Ø 75 | | 2,7W |  330lm |  | 99131 | 9 002759 991319 |
| | Ø 86, ET 26 | Ø 75 | 3 | 3 x 2,7W |  990lm |  | 99135 | 9 002759 991357 |
| | Ø 86, ET 26 | Ø 75 | | 2,7W |  330lm |  IP44 | 99202 | 9 002759 992026 |
| | Ø 86, ET 26 | Ø 75 | | 2,7W |  330lm |  | 99147 | 9 002759 991470 |
| | Ø 86, ET 26 | Ø 75 | | 2,7W |  330lm |  IP44 | 99206 | 9 002759 992064 |
|  steel, satin nickel / plastic, white Stahl, nickel-matt / Kunststoff, weiss acier, nickel mat / plastique, blanc | Ø 86, ET 26 | Ø 75 | | 2,7W |  330lm |  | 99136 | 9 002759 991364 |
| | Ø 86, ET 26 | Ø 75 | 3 | 3 x 2,7W |  990lm |  | 99141 | 9 002759 991418 |
| | Ø 86, ET 26 | Ø 75 | | 2,7W |  330lm |  | 99152 | 9 002759 991524 |
|  steel, chrome / plastic, white Stahl, chrom / Kunststoff, weiss acier, chrome / plastique, blanc | Ø 86, ET 26 | Ø 75 | | 2,7W |  330lm |  IP44 | 99204 | 9 002759 992040 |
| | Ø 86, ET 26 | Ø 75 | | 2,7W |  330lm |  IP44 | 99208 | 9 002759 992088 |
|  steel, black / plastic, white Stahl, schwarz / Kunststoff, weiss acier, noir / plastique, blanc | Ø 86, ET 26 | Ø 75 | | 2,7W |  330lm |  | 99142 | 9 002759 991425 |
| | Ø 86, ET 26 | Ø 75 | 3 | 3 x 2,7W |  990lm |  | 99146 | 9 002759 991463 |
| | Ø 86, ET 26 | Ø 75 | | 2,7W |  330lm |  IP44 | 99211 | 9 002759 992118 |
| | Ø 86, ET 26 | Ø 75 | | 2,7W |  330lm |  | 99156 | 9 002759 991562 |
| | Ø 86, ET 26 | Ø 75 | | 2,7W |  330lm |  IP44 | 99213 | 9 002759 992132 |



FUEVA 5

Ø 117, ET 26

recessed light
Einbauleuchte
luminaire encastrable

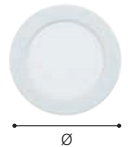

| Material / Colour | Size | Cutout | Watt | Lumen | Item no. | EAN code |
|--|--------------|--------|------|------------------------|----------|---------------------------------|
| steel, white / plastic, white Stahl, weiss / Kunststoff, weiss acier, blanc / plastique, blanc | Ø 117, ET 26 | Ø 105 | 5,5W | warm WHITE 650lm | | 99132 9 002759 991326 |
| | Ø 117, ET 26 | Ø 105 | 5,5W | warm WHITE 650lm | | 99191 9 002759 991913 |
| | Ø 117, ET 26 | Ø 105 | 5,5W | neutral WHITE 700lm | | 99148 9 002759 991487 |
| steel, satin nickel / plastic, white Stahl, nickel-matt / Kunststoff, weiss acier, nickel mat / plastique, blanc | Ø 117, ET 26 | Ø 105 | 5,5W | warm WHITE 650lm | | 99137 9 002759 991371 |
| | Ø 117, ET 26 | Ø 105 | 5,5W | neutral WHITE 700lm | | 99153 9 002759 991531 |
| steel, black / plastic, white Stahl, schwarz / Kunststoff, weiss acier, noir / plastique, blanc | Ø 117, ET 26 | Ø 105 | 5,5W | warm WHITE 650lm | | 99143 9 002759 991432 |
| | Ø 117, ET 26 | Ø 105 | 5,5W | neutral WHITE 700lm | | 99157 9 002759 991579 |



FUEVA-A

Ø 120, ET 30

recessed light
Einbauleuchte
luminaire encastrable

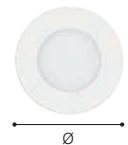

| Material / Colour | Size | Cutout | Watt | Lumen | Item no. | EAN code |
|--|--------------|--------|------|------------------------|------------------------|-----------------|
| aluminium, white / plastic, white Alu, weiss / Kunststoff, weiss aluminium, blanc / plastique, blanc | Ø 120, ET 30 | Ø 108 | 5W | tunable WHITE 700lm | Remote 98212 | 9 002759 982126 |





IP44



FUEVA 5

Water-splash protected luminaires are labelled with an IP value.

Spritzwassergeschützte Leuchten sind mittels IP-Wert gekennzeichnet.

Les luminaires protégés contre les projections d'eau sont identifiés au moyen de la valeur IP.









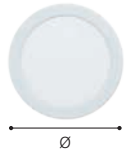



























| | 0 | 1 | 2 | 3 |
|----|---|---|---|---|
| EU | X | X | ✓ | ✓ |
| FR | X | X | X | ✓ |



FUEVA 5
Ø 166, ET 26

recessed light
Einbauleuchte
luminaire encastrable





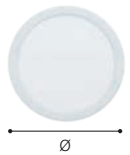













| Material / Colour | Size | Cutout | Watt | Lumen | IP class | Item no. | EAN code |
|--|--------------|--------|------|--|--|--------------|-----------------|
|  steel, white / plastic, white Stahl, weiss / Kunststoff, weiss acier, blanc / plastique, blanc | Ø 166, ET 26 | Ø 155 | 11 W |  warm WHITE 1350 lm |  | 99133 | 9 002759 991333 |
| | Ø 166, ET 26 | Ø 155 | 11 W |  warm WHITE 1350 lm |  | 99192 | 9 002759 991920 |
| | Ø 166, ET 26 | Ø 155 | 11 W |  warm WHITE 1350 lm |   IP44 | 99203 | 9 002759 992033 |
| | Ø 166, ET 26 | Ø 155 | 11 W |  neutral WHITE 1350 lm |  | 99149 | 9 002759 991494 |
| | Ø 166, ET 26 | Ø 155 | 11 W |  neutral WHITE 1350 lm |   IP44 | 99207 | 9 002759 992071 |
|  steel, satin nickel / plastic, white Stahl, nickel-matt / Kunststoff, weiss acier, nickel mat / plastique, blanc | Ø 166, ET 26 | Ø 155 | 11 W |  warm WHITE 1350 lm |  | 99138 | 9 002759 991388 |
| | Ø 166, ET 26 | Ø 155 | 11 W |  neutral WHITE 1350 lm |  | 99154 | 9 002759 991548 |
|  steel, chrome / plastic, white Stahl, chrom / Kunststoff, weiss acier, chrome / plastique, blanc | Ø 166, ET 26 | Ø 155 | 11 W |  warm WHITE 1350 lm |   IP44 | 99205 | 9 002759 992057 |
| | Ø 166, ET 26 | Ø 155 | 11 W |  neutral WHITE 1350 lm |   IP44 | 99209 | 9 002759 992095 |
|  steel, black / plastic, white Stahl, schwarz / Kunststoff, weiss acier, noir / plastique, blanc | Ø 166, ET 26 | Ø 155 | 11 W |  warm WHITE 1350 lm |  | 99144 | 9 002759 991449 |
| | Ø 166, ET 26 | Ø 155 | 11 W |  warm WHITE 1350 lm |   IP44 | 99212 | 9 002759 992125 |
| | Ø 166, ET 26 | Ø 155 | 11 W |  neutral WHITE 1350 lm |  | 99158 | 9 002759 991586 |
| | Ø 166, ET 26 | Ø 155 | 11 W |  neutral WHITE 1350 lm |   IP44 | 99214 | 9 002759 992149 |



FUEVA 5
Ø 216, ET 26

recessed light
Einbauleuchte
luminaire encastrable



| Material / Colour | Size | Cutout | Watt | | Lumen | | Item no. | EAN code |
|---|--------------|--------|------|---|--------|---|--------------|-----------------|
|  steel, white / plastic, white Stahl, weiss / Kunststoff, weiss acier, blanc / plastique, blanc | Ø 216, ET 26 | Ø 205 | 17W |  | 2000lm |  | 99134 | 9 002759 991340 |
| | Ø 216, ET 26 | Ø 205 | 17W |  | 2000lm |  | 99193 | 9 002759 991937 |
| | Ø 216, ET 26 | Ø 205 | 17W |  | 2100lm |  | 99151 | 9 002759 991517 |
|  steel, satin nickel / plastic, white Stahl, nickel-matt / Kunststoff, weiss acier, nickel mat / plastique, blanc | Ø 216, ET 26 | Ø 205 | 17W |  | 2000lm |  | 99139 | 9 002759 991395 |
| | Ø 216, ET 26 | Ø 205 | 17W |  | 2100lm |  | 99155 | 9 002759 991555 |
|  steel, black / plastic, white Stahl, schwarz / Kunststoff, weiss acier, noir / plastique, blanc | Ø 216, ET 26 | Ø 205 | 17W |  | 2000lm |  | 99145 | 9 002759 991456 |
| | Ø 216, ET 26 | Ø 205 | 17W |  | 2100lm |  | 99159 | 9 002759 991593 |





FUEVA 5

L 117, B 117, ET 26

recessed light
Einbauleuchte
luminaire encastrable

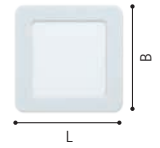

| Material / Colour | Size | Cutout | Watt | | Lumen | | Item no. | EAN code |
|--|---------------------|-----------|------|--|-------|--|--------------|-----------------|
| steel, white / plastic, white Stahl, weiss / Kunststoff, weiss acier, blanc / plastique, blanc | L 117, B 117, ET 26 | 105 x 105 | 5,5W | | 650lm | | 99162 | 9 002759 991623 |
| | L 117, B 117, ET 26 | 105 x 105 | 5,5W | | 700lm | | 99178 | 9 002759 991784 |
| steel, satin nickel / plastic, white Stahl, nickel-matt / Kunststoff, weiss acier, nickel mat / plastique, blanc | L 117, B 117, ET 26 | 105 x 105 | 5,5W | | 650lm | | 99167 | 9 002759 991678 |
| | L 117, B 117, ET 26 | 105 x 105 | 5,5W | | 700lm | | 99183 | 9 002759 991838 |
| steel, black / plastic, white Stahl, schwarz / Kunststoff, weiss acier, noir / plastique, blanc | L 117, B 117, ET 26 | 105 x 105 | 5,5W | | 700lm | | 99187 | 9 002759 991876 |

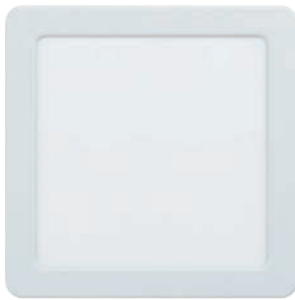

FUEVA 5

L 166, B 166, ET 26

recessed light
Einbauleuchte
luminaire encastrable

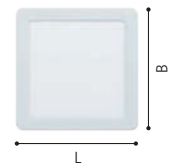

| Material / Colour | Size | Cutout | Watt | | Lumen | | Item no. | EAN code |
|--|---------------------|-----------|------|--|--------|--|--------------|-----------------|
| steel, white / plastic, white Stahl, weiss / Kunststoff, weiss acier, blanc / plastique, blanc | L 166, B 166, ET 26 | 155 x 155 | 11 W | | 1350lm | | 99163 | 9 002759 991630 |
| | L 166, B 166, ET 26 | 155 x 155 | 11 W | | 1350lm | | 99179 | 9 002759 991791 |
| steel, satin nickel / plastic, white Stahl, nickel-matt / Kunststoff, weiss acier, nickel mat / plastique, blanc | L 166, B 166, ET 26 | 155 x 155 | 11 W | | 1350lm | | 99168 | 9 002759 991685 |
| | L 166, B 166, ET 26 | 155 x 155 | 11 W | | 1350lm | | 99184 | 9 002759 991845 |
| steel, black / plastic, white Stahl, schwarz / Kunststoff, weiss acier, noir / plastique, blanc | L 166, B 166, ET 26 | 155 x 155 | 11 W | | 1350lm | | 99188 | 9 002759 991883 |





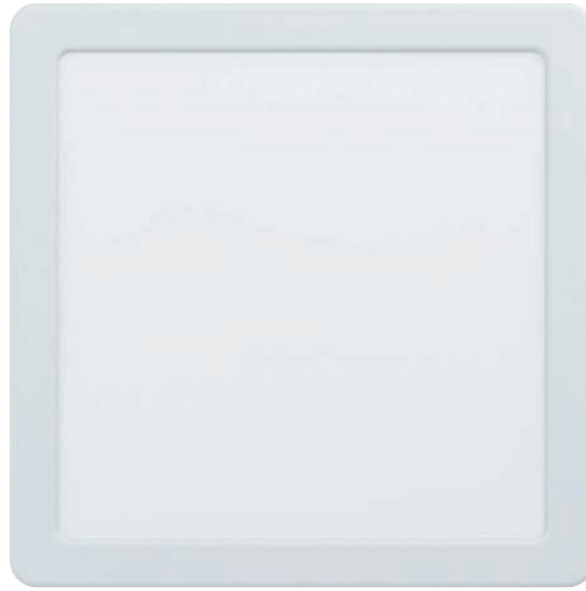







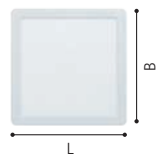







FUEVA 5

L 216, B 216, ET 26

recessed light
Einbauleuchte
luminaire encastrable



| Material / Colour | Size | Cutout | Watt | | Lumen | | Item no. | EAN code |
|--|---------------------|-----------|------|--|--------|---|--------------|-----------------|
|  steel, white / plastic, white Stahl, weiss / Kunststoff, weiss acier, blanc / plastique, blanc | L 216, B 216, ET 26 | 205 x 205 | 17W |  warm WHITE | 2000lm |  | 99164 | 9 002759 991647 |
| | L 216, B 216, ET 26 | 205 x 205 | 17W |  neutral WHITE | 2100lm |  | 99181 | 9 002759 991814 |
|  steel, satin nickel / plastic, white Stahl, nickel-matt / Kunststoff, weiss acier, nickel mat / plastique, blanc | L 216, B 216, ET 26 | 205 x 205 | 17W |  warm WHITE | 2000lm |  | 99169 | 9 002759 991692 |
| | L 216, B 216, ET 26 | 205 x 205 | 17W |  neutral WHITE | 2100lm |  | 99185 | 9 002759 991852 |
|  steel, black / plastic, white Stahl, schwarz / Kunststoff, weiss acier, noir / plastique, blanc | L 216, B 216, ET 26 | 205 x 205 | 17W |  neutral WHITE | 2100lm |  | 99189 | 9 002759 991890 |

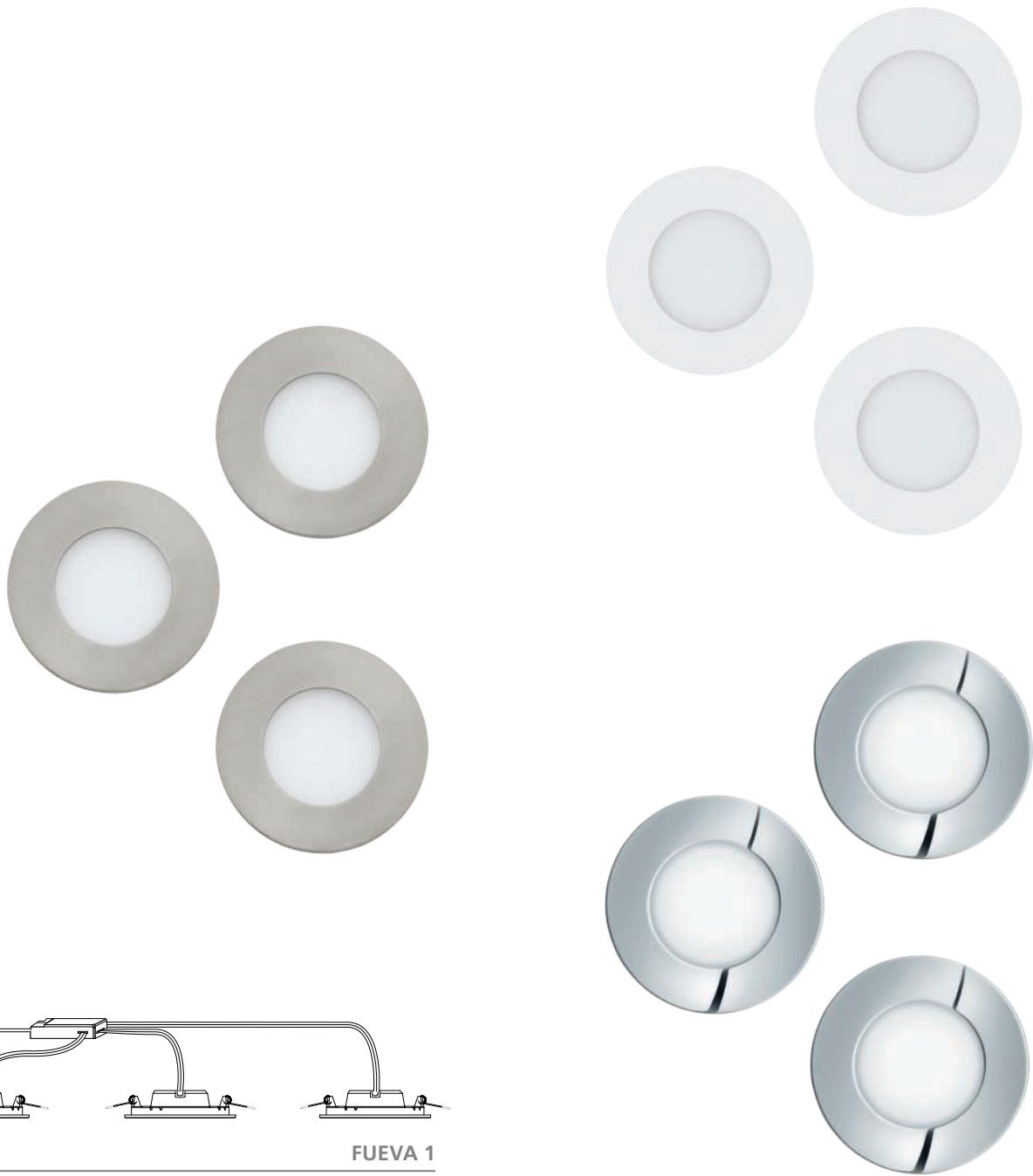

FUEVA 1

3 spots with only one driver.

3 Spots nur mit einen Treiber.













3 places avec un seul conducteur.

FUEVA 1

Ø 85, ET 30

recessed light
Einbauleuchte
luminaire encastrable



| Material / Colour | Size | Cutout | Quantity | Watt | Lumen | IP class | Item no. | EAN code |
|--|-------------|--------|----------|----------|--|--|--------------|-----------------|
|  cast metal, white / plastic, white Metallguss, weiss / Kunststoff, weiss fonte métallique, blanc / plastique, blanc | Ø 85, ET 30 | Ø 74 | 3 | 3 x 2,8W |  1050lm |   IP20/44 | 98633 | 9 002759 986339 |
|  cast metal, satin nickel / plastic, white Metallguss, nickel-matt / Kunststoff, weiss fonte métallique, nickel mat / plastique, blanc | Ø 85, ET 30 | Ø 74 | 3 | 3 x 2,8W |  1050lm |   IP20/44 | 98634 | 9 002759 986346 |
|  cast metal, chrome / plastic, white Metallguss, chrom / Kunststoff, weiss fonte métallique, chrome / plastique, blanc | Ø 85, ET 30 | Ø 74 | 3 | 3 x 2,8W |  1050lm |   IP20/44 | 98635 | 9 002759 986353 |



IP44



FUEVA 1

Water-splash protected luminaires are labelled with an IP value.

Spritzwassergeschützte Leuchten sind mittels IP-Wert gekennzeichnet.

Les luminaires protégés contre les projections d'eau sont identifiés au moyen de la valeur IP.

| | 0 | 1 | 2 | 3 |
|----|---|---|---|---|
| EU | X | X | ✓ | ✓ |
| FR | X | X | X | ✓ |



FUEVA FLEX

Flexible mounting bracket for various ceiling cut-outs from 68-100 mm.

Flexibler Einbaubügel für verschiedene Deckenausschnitte von 68-100 mm.

Support de montage flexible pour différentes découpes de plafond de 68 à 100 mm.

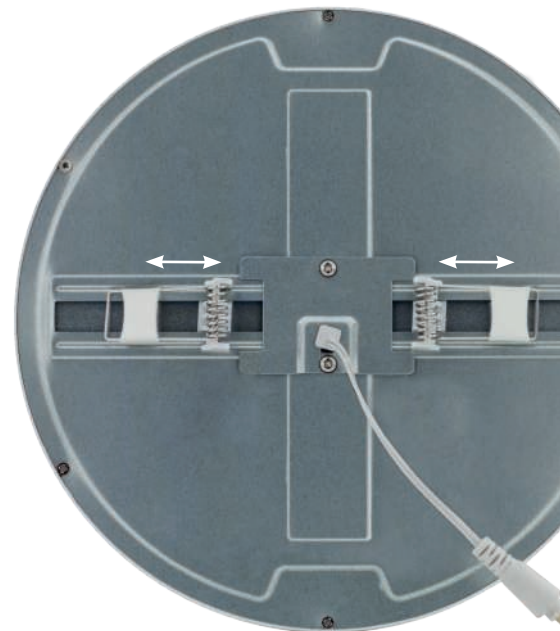

FUEVA FLEX

Flexible mounting bracket for various ceiling cut-outs from 70-200 mm.

Flexibler Einbaubügel für verschiedene Deckenausschnitte von 70-200 mm.

Support de montage flexible pour différentes découpes de plafond de 70 à 200 mm.

















FUEVA FLEX

H 2, Ø 117

recessed light
Einbauleuchte
luminaire encastrable



| Material / Colour | Size | Cutout | Watt | | Lumen | | Item no. | EAN code |
|--|------------|----------|------|--|-------|--|---------------|-----------------|
|  aluminium, white / plastic, white Alu, weiss / Kunststoff, weiss aluminium, blanc / plastique, blanc | H 2, Ø 117 | Ø 68-100 | 5,5W |  | 650lm |  | 900932 | 9 008606 277735 |
| | H 2, Ø 117 | Ø 68-100 | 5,5W |  | 700lm |  | 900935 | 9 008606 277766 |
|  aluminium, satin nickel / plastic, white Alu, nickel-matt / Kunststoff, weiss aluminium, nickel mat / plastique, blanc | H 2, Ø 117 | Ø 68-100 | 5,5W |  | 650lm |  | 900933 | 9 008606 277742 |
| | H 2, Ø 117 | Ø 68-100 | 5,5W |  | 700lm |  | 900936 | 9 008606 277773 |
|  aluminium, black / plastic, white Alu, schwarz / Kunststoff, weiss aluminium, noir / plastique, blanc | H 2, Ø 117 | Ø 68-100 | 5,5W |  | 650lm |  | 900931 | 9 008606 277728 |
| | H 2, Ø 117 | Ø 68-100 | 5,5W |  | 700lm |  | 900934 | 9 008606 277759 |





FUEVA FLEX

H 25, Ø 225

recessed light
Einbauleuchte
luminaire encastrable



| Material / Colour | Size | Cutout | Watt | | Lumen | | Item no. | EAN code |
|--|-------------|----------|------|---|--------|---|--------------|-----------------|
|  aluminium, white / plastic, white Alu, weiss / Kunststoff, weiss aluminium, blanc / plastique, blanc | H 25, Ø 225 | Ø 70-200 | 22W |  | 2800lm |  | 98865 | 9 002759 988654 |
| | H 25, Ø 225 | Ø 70-200 | 22W |  | 2800lm |  | 98868 | 9 002759 988685 |
|  aluminium, satin nickel / plastic, white Alu, nickel-matt / Kunststoff, weiss aluminium, nickel mat / plastique, blanc | H 25, Ø 225 | Ø 70-200 | 22W |  | 2800lm |  | 98866 | 9 002759 988661 |
| | H 25, Ø 225 | Ø 70-200 | 22W |  | 2800lm |  | 98869 | 9 002759 988692 |
|  aluminium, black / plastic, white Alu, schwarz / Kunststoff, weiss aluminium, noir / plastique, blanc | H 25, Ø 225 | Ø 70-200 | 22W |  | 2800lm |  | 98867 | 9 002759 988678 |
| | H 25, Ø 225 | Ø 70-200 | 22W |  | 2800lm |  | 98871 | 9 002759 988715 |



SURFACE DOWNLIGHTS

ADVANTAGES

- > DISCREET IN APPEARANCE, PERFECT IN STAGING
 - > SET THE SCENE IN YOUR HOME
 - > IMPRESS WITH THEIR UNCOMPLICATED APPLICATION
 - > ARE ENERGY AND COST-SAVING THANKS TO THE LED CIRCUIT BOARDS AND LED LIGHT SOURCES
-

VORTEILE

- > DEZENT IM AUFTRETEN, PERFEKT IN DER INSZENIERUNG
 - > SETZEN IHR ZUHAUSE IN SZENE
 - > ÜBERZEUGEN MIT IHRER UNKOMPLIZIERTEN ANWENDUNG
 - > SIND AUFGRUND DER LED-PLATINEN UND LED-LEUCHTMITTEL STROM- UND KOSTENSPAREND
-

AVANTAGES

AVANTAGES

- > DISCRET DANS SON APPARENCE, PARFAIT DANS SA MISE EN SCÈNE
- > METTENT VOTRE MAISON EN SCÈNE
- > CONVAINQUENT PAR LEUR SIMPLICITÉ D'UTILISATION
- > SONT ÉCONOMES EN ÉNERGIE ET EN COÛTS GRÂCE AUX PLATINES LED ET AUX SOURCES LUMINEUSES LED



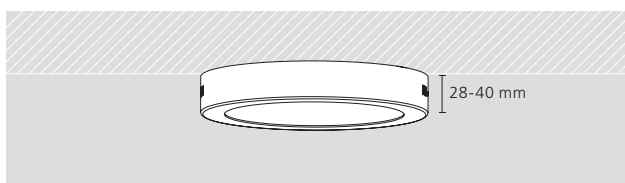

SURFACE DOWNLIGHTS

FUEVA

ADVANTAGES

- > SLIM DESIGN WITH LOW SURFACE HEIGHT (28 TO 40 MM)
- > AVAILABLE IN VARIOUS MATERIAL & COLOURS, SHAPES AND IP CLASSES.
- > LOW TEMPERATURE ENHANCES SAFETY
- > UP TO 80% POWER SAVINGS COMPARED TO INCANDESCENT LAMPS, EASY ON YOUR BUDGET AND THE ENVIRONMENT

VORTEILE

- > SCHLANKE BAUFORM MIT GERINGER AUFBAUHÖHE (28 BIS 40 MM)
- > ERHÄLTlich IN VERSCHIEDENEN FARBEN, FORMEN UND IP-KLASSEN.
- > GERINGE WÄRMEENTWICKLUNG SORGT FÜR MEHR SICHERHEIT
- > BIS ZU 80% STROMERSPARNIS GEGENÜBER GLÜHLAMPEN, SCHONT IHR BUDGET UND DIE UMWELT

AVANTAGES

- > CONCEPTION MINCE AVEC LA HAUTEUR DE SAILIE MINIMALE (DE 28 À 40 MM)
- > DISPONIBLE EN DIFFÉRENTES COULEURS, FORMES ET CLASSES IP.
- > FAIBLE CHALEUR AMÉLIORE LA SÉCURITÉ
- > JUSQU'À 80% D'ÉCONOMIES D'ÉNERGIE PAR RAPPORT AUX LAMPES À INCANDESCENCE, RÉDUIT VOTRE BUDGET ET PROTÈGE L'ENVIRONNEMENT

OVERVIEW



FUEVA-A
260



FUEVA 5
263-272



FUEVA 1
274



This product is available in different colors and shapes./ Dieser Artikel ist in unterschiedlichen Farben und Formen verfügbar./
Cet article est disponible en différentes couleurs et formes.



FUEVA-A

H 30, Ø 225

surface-mounted light
Aufbauleuchte
luminaire en saillie



incl./inkl./inclus



| Material / Colour | Size | Watt | Lumen | Item no. | EAN code |
|--|-------------|------|--------|------------------------|-----------------|
| aluminium, white / plastic, white Alu, weiss / Kunststoff, weiss aluminium, blanc / plastique, blanc | H 30, Ø 225 | 14 W | 2000lm | Remote 98292 | 9 002759 982928 |

FUEVA-A

H 30, Ø 300

surface-mounted light
Aufbauleuchte
luminaire en saillie



incl./inkl./inclus



| Material / Colour | Size | Watt | Lumen | Item no. | EAN code |
|--|-------------|------|--------|------------------------|-----------------|
| aluminium, white / plastic, white Alu, weiss / Kunststoff, weiss aluminium, blanc / plastique, blanc | H 30, Ø 300 | 20 W | 2650lm | Remote 98293 | 9 002759 982935 |





IP44



FUEVA 5

Water-splash protected luminaires are labelled with an IP value.

Spritzwassergeschützte Leuchten sind mittels IP-Wert gekennzeichnet.

Les luminaires protégés contre les projections d'eau sont identifiés au moyen de la valeur IP.

| | 0 | 1 | 2 | 3 |
|----|---|---|---|---|
| EU | X | X | ✓ | ✓ |
| FR | X | X | X | ✓ |



FUEVA 5

H 28, Ø 160

surface-mounted light
Aufbauleuchte
luminaire en saillie



| Material / Colour | Size | Watt | Lumen | IP class | Item no. | EAN code |
|--|-------------|------|--------|----------|---------------|-----------------|
| steel, white / plastic, white Stahl, weiss / Kunststoff, weiss acier, blanc / plastique, blanc | H 28, Ø 160 | 11 W | 1350lm | | 99215 | 9 002759 992156 |
| | H 28, Ø 160 | 11 W | 1350lm | | 900582 | 9 008606 244829 |
| | H 28, Ø 160 | 11 W | 1350lm | IP44 | 900638 | 9 008606 245222 |
| | H 28, Ø 160 | 11 W | 1350lm | | 99225 | 9 002759 992255 |
| steel, satin nickel / plastic, white Stahl, nickel-matt / Kunststoff, weiss acier, nickel mat / plastique, blanc | H 28, Ø 160 | 11 W | 1350lm | | 99218 | 9 002759 992187 |
| | H 28, Ø 160 | 11 W | 1350lm | | 900583 | 9 008606 244836 |
| | H 28, Ø 160 | 11 W | 1350lm | | 99228 | 9 002759 992286 |
| steel, chrome / plastic, white Stahl, chrom / Kunststoff, weiss acier, chrome / plastique, blanc | H 28, Ø 160 | 11 W | 1350lm | IP44 | 900639 | 9 008606 245239 |
| steel, black / plastic, white Stahl, schwarz / Kunststoff, weiss acier, noir / plastique, blanc | H 28, Ø 160 | 11 W | 1350lm | | 99222 | 9 002759 992224 |
| | H 28, Ø 160 | 11 W | 1350lm | | 900581 | 9 008606 244812 |
| | H 28, Ø 160 | 11 W | 1350lm | IP44 | 900637 | 9 008606 245215 |
| | H 28, Ø 160 | 11 W | 1350lm | | 99233 | 9 002759 992330 |



FUEVA 5

H 28, Ø 210

surface-mounted light
Aufbauleuchte
luminaire en saillie



| Material / Colour | Size | Watt | Lumen | IP class | Sensor | Item no. | EAN code | |
|--|-------------|------|--------|----------|--------|----------------------|-----------------|-----------------|
| steel, white / plastic, white Stahl, weiss / Kunststoff, weiss acier, blanc / plastique, blanc | H 28, Ø 210 | 17W | 2000lm | | | 99216 | 9 002759 992163 | |
| | H 28, Ø 210 | 17W | 2000lm | | | 99258 | 9 002759 992583 | |
| | H 28, Ø 210 | 17W | 2000lm | | | | 900654 | 9 008606 245369 |
| | H 28, Ø 210 | 17W | 2000lm | | | 160°, 2 m 20 sec. | 901011 | 9 008606 299508 |
| | H 28, Ø 210 | 17W | 2100lm | | | | 99226 | 9 002759 992262 |
| steel, satin nickel / plastic, white Stahl, nickel-matt / Kunststoff, weiss acier, nickel mat / plastique, blanc | H 28, Ø 210 | 17W | 2000lm | | | 99219 | 9 002759 992194 | |
| | H 28, Ø 210 | 17W | 2000lm | | | 900584 | 9 008606 244843 | |
| | H 28, Ø 210 | 17W | 2100lm | | | | 99229 | 9 002759 992293 |
| steel, chrome / plastic, white Stahl, chrom / Kunststoff, weiss acier, chrome / plastique, blanc | H 28, Ø 210 | 17W | 2000lm | | | | 900641 | 9 008606 245246 |
| steel, black / plastic, white Stahl, schwarz / Kunststoff, weiss acier, noir / plastique, blanc | H 28, Ø 210 | 17W | 2000lm | | | 99223 | 9 002759 992231 | |
| | H 28, Ø 210 | 17W | 2000lm | | | 99263 | 9 002759 992637 | |
| | H 28, Ø 210 | 17W | 2000lm | | | | 900653 | 9 008606 245352 |
| | H 28, Ø 210 | 17W | 2000lm | | | 160°, 2 m 20 sec. | 901013 | 9 008606 299522 |
| | H 28, Ø 210 | 17W | 2100lm | | | | 99234 | 9 002759 992347 |
| steel, brushed brass / plastic, white Stahl, messing-gebürstet / Kunststoff, weiss acier, laiton brossé / plastique, blanc | H 28, Ø 210 | 17W | 2000lm | | | | 900181 | 9 008606 229567 |



FUEVA 5

H 28, Ø 285

surface-mounted light
Aufbauleuchte
luminaire en saillie

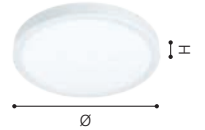

| Material / Colour | Size | Watt | Lumen | IP class | Sensor | Item no. | EAN code | |
|--|-------------|-------|----------------------------|----------|--------|----------------------|-----------------|-----------------|
| steel, white / plastic, white Stahl, weiss / Kunststoff, weiss acier, blanc / plastique, blanc | H 28, Ø 285 | 20,5W | warm WHITE 2400lm | | | 99217 | 9 002759 992170 | |
| | H 28, Ø 285 | 20,5W | warm WHITE 2400lm | | | 99259 | 9 002759 992590 | |
| | H 28, Ø 285 | 20,5W | warm WHITE 2400lm | | | | 99265 | 9 002759 992651 |
| | H 28, Ø 285 | 20,5W | warm WHITE 2400lm | | | 160°, 2 m 20 sec. | 901012 | 9 008606 299515 |
| | H 28, Ø 285 | 20,5W | neutral WHITE 2500lm | | | | 99227 | 9 002759 992279 |
| | H 28, Ø 285 | 20,5W | neutral WHITE 2500lm | | | | 30891 | 9 002759 308919 |
| steel, satin nickel / plastic, white Stahl, nickel-matt / Kunststoff, weiss acier, nickel mat / plastique, blanc | H 28, Ø 285 | 20,5W | warm WHITE 2400lm | | | 99221 | 9 002759 992217 | |
| | H 28, Ø 285 | 20,5W | warm WHITE 2400lm | | | 900585 | 9 008606 244850 | |
| | H 28, Ø 285 | 20,5W | neutral WHITE 2500lm | | | | 99232 | 9 002759 992323 |
| steel, chrome / plastic, white Stahl, chrom / Kunststoff, weiss acier, chrome / plastique, blanc | H 28, Ø 285 | 20,5W | warm WHITE 2400lm | | | 99266 | 9 002759 992668 | |
| | H 28, Ø 285 | 20,5W | neutral WHITE 2500lm | | | 30892 | 9 002759 308926 | |
| steel, black / plastic, white Stahl, schwarz / Kunststoff, weiss acier, noir / plastique, blanc | H 28, Ø 285 | 20,5W | warm WHITE 2400lm | | | 99224 | 9 002759 992248 | |
| | H 28, Ø 285 | 20,5W | warm WHITE 2400lm | | | 99264 | 9 002759 992644 | |
| | H 28, Ø 285 | 20,5W | warm WHITE 2400lm | | | | 99267 | 9 002759 992675 |
| | H 28, Ø 285 | 20,5W | warm WHITE 2400lm | | | 160°, 2 m 20 sec. | 901014 | 9 008606 299539 |
| | H 28, Ø 285 | 20,5W | neutral WHITE 2500lm | | | | 99235 | 9 002759 992354 |
| | H 28, Ø 285 | 20,5W | neutral WHITE 2500lm | | | | 30761 | 9 002759 307615 |
| steel, brushed brass / plastic, white Stahl, messing-gebürstet / Kunststoff, weiss acier, laiton brossé / plastique, blanc | H 28, Ø 285 | 20,5W | warm WHITE 2400lm | | | 900182 | 9 008606 229574 | |



IP44



FUEVA 5

Water-splash protected luminaires are labelled with an IP value.

Spritzwassergeschützte Leuchten sind mittels IP-Wert gekennzeichnet.

Les luminaires protégés contre les projections d'eau sont identifiés au moyen de la valeur IP.

| | 0 | 1 | 2 | 3 |
|----|---|---|---|---|
| EU | X | X | ✓ | ✓ |
| FR | X | X | X | ✓ |

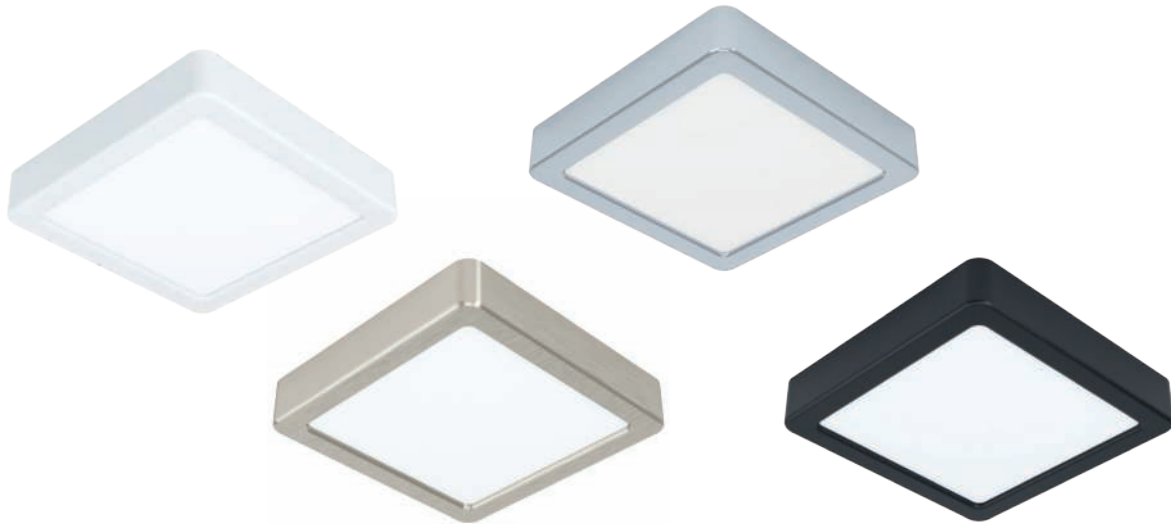

FUEVA 5

L 160, B 160, H 28

surface-mounted light
Aufbauleuchte
luminaire en saillie

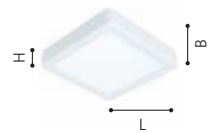

| Material / Colour | Size | Watt | Lumen | IP class | Item no. | EAN code |
|--|--------------------|------|--------|----------|---------------|-----------------|
| steel, white / plastic, white Stahl, weiss / Kunststoff, weiss acier, blanc / plastique, blanc | L 160, B 160, H 28 | 11 W | 1350lm | | 99236 | 9 002759 992361 |
| | L 160, B 160, H 28 | 11 W | 1350lm | | 900589 | 9 008606 244898 |
| | L 160, B 160, H 28 | 11 W | 1350lm | | 900646 | 9 008606 245291 |
| | L 160, B 160, H 28 | 11 W | 1350lm | | 99246 | 9 002759 992460 |
| steel, satin nickel / plastic, white Stahl, nickel-matt / Kunststoff, weiss acier, nickel mat / plastique, blanc | L 160, B 160, H 28 | 11 W | 1350lm | | 99239 | 9 002759 992392 |
| | L 160, B 160, H 28 | 11 W | 1350lm | | 900593 | 9 008606 244928 |
| | L 160, B 160, H 28 | 11 W | 1350lm | | 99252 | 9 002759 992521 |
| steel, chrome / plastic, white Stahl, chrom / Kunststoff, weiss acier, chrome / plastique, blanc | L 160, B 160, H 28 | 11 W | 1350lm | | 900649 | 9 008606 245321 |
| steel, black / plastic, white Stahl, schwarz / Kunststoff, weiss acier, noir / plastique, blanc | L 160, B 160, H 28 | 11 W | 1350lm | | 99243 | 9 002759 992439 |
| | L 160, B 160, H 28 | 11 W | 1350lm | | 900586 | 9 008606 244867 |
| | L 160, B 160, H 28 | 11 W | 1350lm | | 900643 | 9 008606 245260 |
| | L 160, B 160, H 28 | 11 W | 1350lm | | 99255 | 9 002759 992552 |





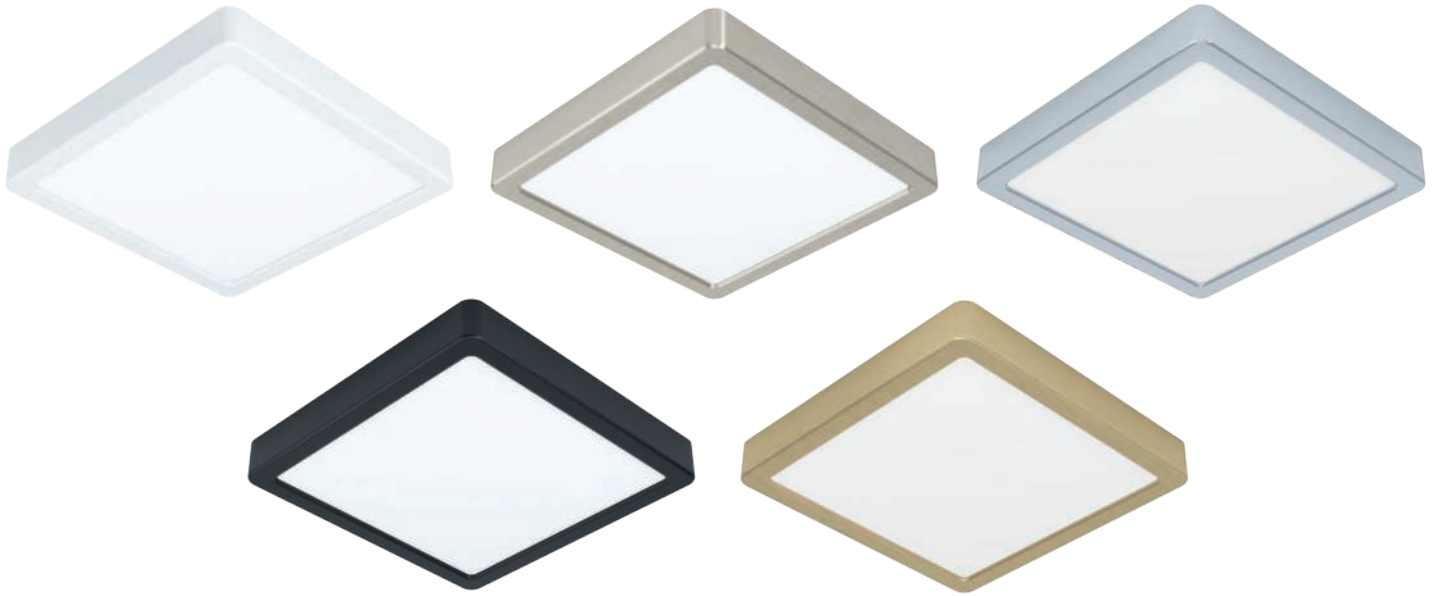

FUEVA 5
L 210, B 210, H 28

surface-mounted light
Aufbauleuchte
luminaire en saillie

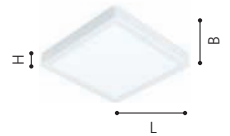

| Material / Colour | Size | Watt | Lumen | IP class | Item no. | EAN code |
|--|--------------------|------|--------|----------|---------------|-----------------|
| steel, white / plastic, white Stahl, weiss / Kunststoff, weiss acier, blanc / plastique, blanc | L 210, B 210, H 28 | 17W | 2000lm | | 99237 | 9 002759 992378 |
| | L 210, B 210, H 28 | 17W | 2000lm | | 900591 | 9 008606 244904 |
| | L 210, B 210, H 28 | 17W | 2000lm | IP44 | 900647 | 9 008606 245307 |
| | L 210, B 210, H 28 | 17W | 2100lm | | 99247 | 9 002759 992477 |
| steel, satin nickel / plastic, white Stahl, nickel-matt / Kunststoff, weiss acier, nickel mat / plastique, blanc | L 210, B 210, H 28 | 17W | 2000lm | | 99241 | 9 002759 992415 |
| | L 210, B 210, H 28 | 17W | 2000lm | | 900594 | 9 008606 244935 |
| | L 210, B 210, H 28 | 17W | 2100lm | | 99253 | 9 002759 992538 |
| steel, chrome / plastic, white Stahl, chrom / Kunststoff, weiss acier, chrome / plastique, blanc | L 210, B 210, H 28 | 17W | 2000lm | IP44 | 900651 | 9 008606 245338 |
| steel, black / plastic, white Stahl, schwarz / Kunststoff, weiss acier, noir / plastique, blanc | L 210, B 210, H 28 | 17W | 2000lm | | 99244 | 9 002759 992446 |
| | L 210, B 210, H 28 | 17W | 2000lm | | 900587 | 9 008606 244874 |
| | L 210, B 210, H 28 | 17W | 2000lm | IP44 | 900644 | 9 008606 245277 |
| | L 210, B 210, H 28 | 17W | 2100lm | | 99256 | 9 002759 992569 |
| steel, brushed brass / plastic, white Stahl, messing-gebürstet / Kunststoff, weiss acier, laiton brossé / plastique, blanc | L 210, B 210, H 28 | 17W | 2000lm | | 900183 | 9 008606 229581 |

FUEVA 5

L 285, B 285, H 28

surface-mounted light

Aufbauleuchte

luminaire en saillie

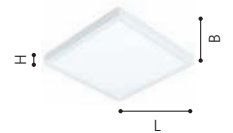

| Material / Colour | Size | Watt | | Lumen | | IP class | Item no. | EAN code |
|--|--------------------|-------|--|--------|--|----------|---------------|-----------------|
| steel, white / plastic, white Stahl, weiss / Kunststoff, weiss acier, blanc / plastique, blanc | L 285, B 285, H 28 | 20,5W | | 2400lm | | | 99238 | 9 002759 992385 |
| | L 285, B 285, H 30 | 20,5W | | 2400lm | | | 99268 | 9 002759 992682 |
| | L 285, B 285, H 28 | 20,5W | | 2400lm | | | 900592 | 9 008606 244911 |
| | L 285, B 285, H 28 | 20,5W | | 2500lm | | | 99248 | 9 002759 992484 |
| | L 285, B 285, H 30 | 20,5W | | 2500lm | | | 30893 | 9 002759 308933 |
| steel, satin nickel / plastic, white Stahl, nickel-matt / Kunststoff, weiss acier, nickel mat / plastique, blanc | L 285, B 285, H 28 | 20,5W | | 2400lm | | | 99242 | 9 002759 992422 |
| | L 285, B 285, H 28 | 20,5W | | 2400lm | | | 900595 | 9 008606 244942 |
| | L 285, B 285, H 28 | 20,5W | | 2500lm | | | 99254 | 9 002759 992545 |
| steel, chrome / plastic, white Stahl, chrom / Kunststoff, weiss acier, chrome / plastique, blanc | L 285, B 285, H 30 | 20,5W | | 2400lm | | | 99269 | 9 002759 992699 |
| | L 285, B 285, H 30 | 20,5W | | 2500lm | | | 30894 | 9 002759 308940 |
| steel, black / plastic, white Stahl, schwarz / Kunststoff, weiss acier, noir / plastique, blanc | L 285, B 285, H 28 | 20,5W | | 2400lm | | | 99245 | 9 002759 992453 |
| | L 285, B 285, H 30 | 20,5W | | 2400lm | | | 99271 | 9 002759 992712 |
| | L 285, B 285, H 28 | 20,5W | | 2400lm | | | 900588 | 9 008606 244881 |
| | L 285, B 285, H 28 | 20,5W | | 2500lm | | | 99257 | 9 002759 992576 |
| | L 285, B 285, H 30 | 20,5W | | 2500lm | | | 30762 | 9 002759 307622 |
| steel, brushed brass / plastic, white Stahl, messing-gebürstet / Kunststoff, weiss acier, laiton brossé / plastique, blanc | L 285, B 285, H 28 | 20,5W | | 2400lm | | | 900184 | 9 008606 229598 |



IP44



FUEVA 5

Water-splash protected luminaires are labelled with an IP value.

Spritzwassergeschützte Leuchten sind mittels IP-Wert gekennzeichnet.

Les luminaires protégés contre les projections d'eau sont identifiés au moyen de la valeur IP.

| | 0 | 1 | 2 | 3 |
|----|---|---|---|---|
| EU | X | X | ✓ | ✓ |
| FR | X | X | X | ✓ |

FUEVA 1

H 30, Ø 400

surface-mounted light
Aufbauleuchte
luminaire en saillie

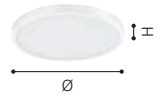

| Material / Colour | Size | Watt | | Lumen | | Item no. | EAN code |
|---|-------------|-------|--|--------|--|--------------|-----------------|
| aluminium, white / plastic, white Alu, weiss / Kunststoff, weiss aluminium, blanc / plastique, blanc | H 30, Ø 400 | 22,3W | | 2500lm | | 97262 | 9 002759 972622 |
| | H 30, Ø 400 | 22,3W | | 2600lm | | 97266 | 9 002759 972660 |
| aluminium, silver / plastic, white Alu, silber / Kunststoff, weiss aluminium, argent / plastique, blanc | H 30, Ø 400 | 22,3W | | 2500lm | | 97263 | 9 002759 972639 |
| | H 30, Ø 400 | 22,3W | | 2600lm | | 97267 | 9 002759 972677 |

FUEVA 1

H 30, Ø 500

surface-mounted light
Aufbauleuchte
luminaire en saillie



| Material / Colour | Size | Watt | | Lumen | | Item no. | EAN code |
|--|-------------|------|--|--------|--|--------------|-----------------|
| aluminium, white / plastic, white Alu, weiss / Kunststoff, weiss aluminium, blanc / plastique, blanc | H 30, Ø 500 | 26W | | 3000lm | | 97271 | 9 002759 972714 |

FUEVA 1

H 30, Ø 600

surface-mounted light
Aufbauleuchte
luminaire en saillie



| Material / Colour | Size | Watt | | Lumen | | Item no. | EAN code |
|--|-------------|------|--|--------|--|--------------|-----------------|
| aluminium, white / plastic, white Alu, weiss / Kunststoff, weiss aluminium, blanc / plastique, blanc | H 30, Ø 600 | 27W | | 3400lm | | 97279 | 9 002759 972790 |

FUEVA 1

L 400, B 400, H 30

surface-mounted light
Aufbauleuchte
luminaire en saillie

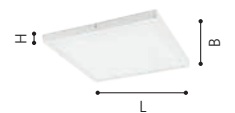

| Material / Colour | Size | Watt | | Lumen | | Item no. | EAN code |
|---|--------------------|------|--|--------|--|--------------|-----------------|
| aluminium, white / plastic, white Alu, weiss / Kunststoff, weiss aluminium, blanc / plastique, blanc | L 400, B 400, H 30 | 22W | | 2500lm | | 97264 | 9 002759 972646 |
| | L 400, B 400, H 30 | 22W | | 2600lm | | 97268 | 9 002759 972684 |
| aluminium, silver / plastic, white Alu, silber / Kunststoff, weiss aluminium, argent / plastique, blanc | L 400, B 400, H 30 | 22W | | 2500lm | | 97265 | 9 002759 972653 |
| | L 400, B 400, H 30 | 22W | | 2600lm | | 97269 | 9 002759 972691 |



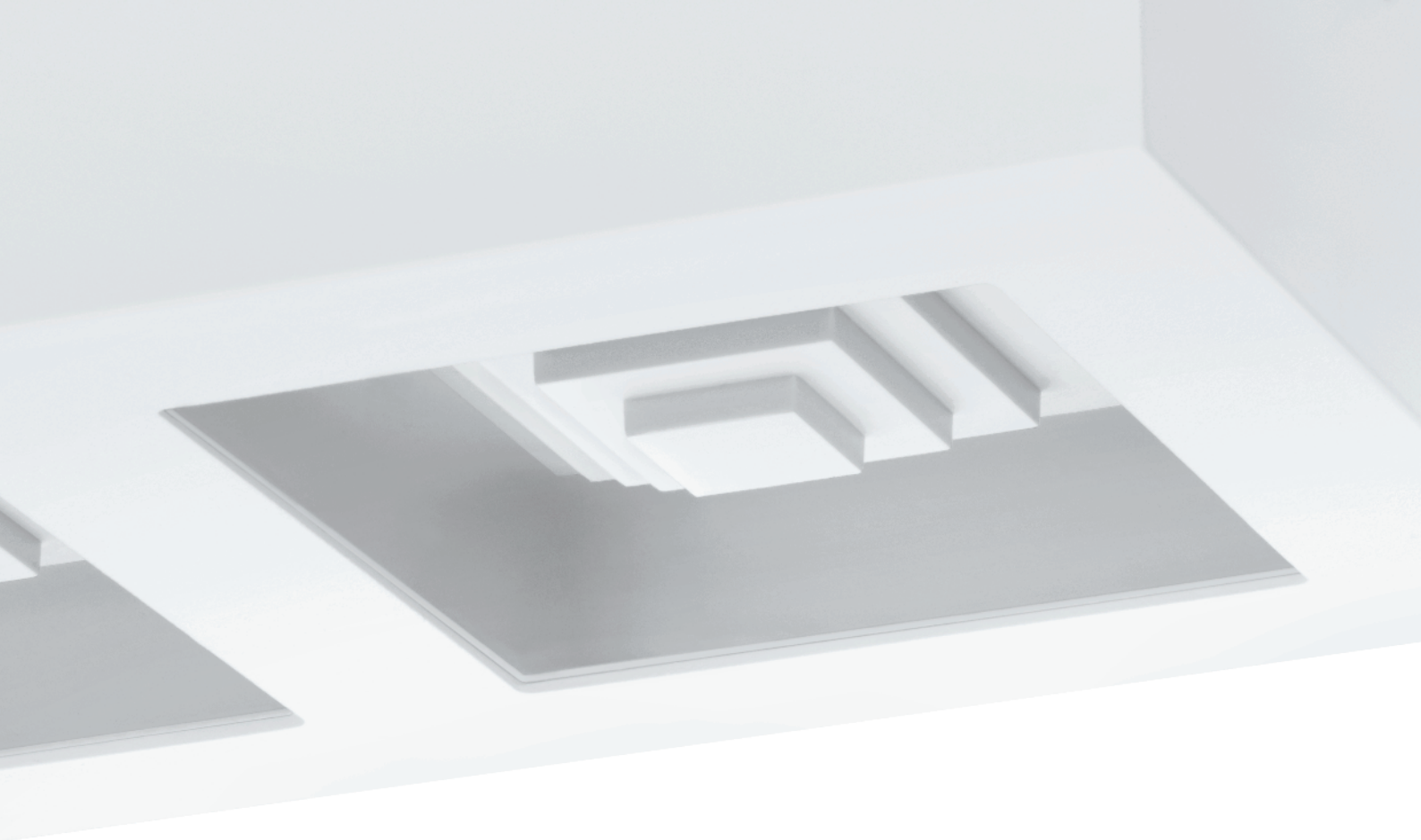

SURFACE DOWNLIGHTS

DECORATIVE

ADVANTAGES

- > UNIFORM DISTRIBUTION OF INDIRECT LIGHT - IDEAL FOR ILLUMINATING SPACES AND SURFACES
 - > LOW TEMPERATURE ENHANCES SAFETY
 - > UP TO 80% POWER SAVINGS COMPARED TO INCANDESCENT LAMPS, EASY ON YOUR BUDGET AND THE ENVIRONMENT
-

VORTEILE

- > HOMOGENES, INDIREKTES LICHT – IDEAL ZUR BELEUCHTUNG VON RÄUMEN UND FLÄCHEN
 - > GERINGE WÄRMEENTWICKLUNG SORGT FÜR MEHR SICHERHEIT
 - > BIS ZU 80% STROMERSPARNIS GEGENÜBER GLÜHLAMPEN, SCHONT IHR BUDGET UND DIE UMWELT
-

AVANTAGES

- > LA DISTRIBUTION UNIFORME DE LA LUMIÈRE INDIRECTE - IDÉAL POUR LES ESPACES ET LES SURFACES ÉCLAIRANTES
- > FAIBLE CHALEUR AMÉLIORE LA SÉCURITÉ
- > JUSQU'À 80% D'ÉCONOMIES D'ÉNERGIE PAR RAPPORT AUX LAMPES À INCANDESCENCE, RÉDUIT VOTRE BUDGET ET PROTÈGE L'ENVIRONNEMENT

OVERVIEW



CRESPILLO
278-279



BOHOYO
280



POLASSO
282-284



FERREROS
286



This product is available in different colors and shapes./ Dieser Artikel ist in unterschiedlichen Farben und Formen verfügbar./
Cet article est disponible en différentes couleurs et formes.



99726

LED



99337

LED



99338

LED

99337 CRESPILLO

surface-mounted light; plastic, steel, white / plastic, white
 Aufbauleuchte; Kunststoff, Stahl, weiss / Kunststoff, weiss
 luminaire en saillie; plastique, acier, blanc / plastique, blanc

H 45, Ø 240

LED

12,5W

neutral
WHITE

1350lm



99338 CRESPILLO

surface-mounted light; plastic, steel, white / plastic, white
 Aufbauleuchte; Kunststoff, Stahl, weiss / Kunststoff, weiss
 luminaire en saillie; plastique, acier, blanc / plastique, blanc

H 45, Ø 315

LED

15W

neutral
WHITE

1800lm



9 002759 993375



9 002759 993382





99726

LED



99727

LED

99726 CRESPILLO

surface-mounted light; plastic, white / plastic, white
Aufbauleuchte; Kunststoff, weiss / Kunststoff, weiss
luminaire en saillie; plastique, blanc / plastique, blanc

H 65, Ø 380

LED

21 W

neutral
WHITE

3000lm



99727 CRESPILLO

surface-mounted light; plastic, white / plastic, white
Aufbauleuchte; Kunststoff, weiss / Kunststoff, weiss
luminaire en saillie; plastique, blanc / plastique, blanc

H 65, Ø 500

LED

29 W

neutral
WHITE

4800lm



9 002759 997267

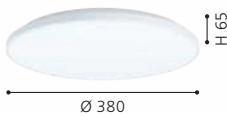

9 002759 997274

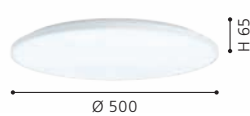



901043



901044



BOHOYO

These luminaires can be used as recessed or surface-mounted lights. The head of the light is surface-mounted lights. The head of the light is movable and can be rotated.

Diese Leuchten können als Ein- oder Aufbauleuchten verwendet werden. Der Kopf der Leuchte ist beweglich und kann gedreht werden.

Ces luminaires peuvent être utilisés comme luminaires encastrés ou apparents. La tête du luminaire est mobile et peut être tournée.



901043 BOHOYO

spot; aluminium, white / plastic, transparent
Spot; Alu, weiss / Kunststoff, transparent
spot; aluminium, blanc / plastique, transparent

L 100, H 110, ET 40



1x 8W 1000lm



9 008606 315949



901044 BOHOYO

spot; aluminium, black / plastic, transparent
Spot; Alu, schwarz / Kunststoff, transparent
spot; aluminium, noir / plastique, transparent

L 100, H 110, ET 40



1x 8W 1000lm



9 008606 315956





901044

LED





94501

LED



94502

LED



94504

LED

94501 POLASSO

ceiling light; aluminium, plastic, black, copper
Deckenleuchte; Alu, Kunststoff, schwarz, kupfer
plafonnier; aluminium, plastique, noir, cuivre

H 120, Ø 100



3,3W 340lm



9 002759 945015



94504 POLASSO

ceiling light; aluminium, plastic, white, silver
Deckenleuchte; Alu, Kunststoff, weiss, silber
plafonnier; aluminium, plastique, blanc, argent

H 120, Ø 100



3,3W 340lm



9 002759 945046



94502 POLASSO

ceiling light; aluminium, plastic, black, gold
Deckenleuchte; Alu, Kunststoff, schwarz, gold
plafonnier; aluminium, plastique, noir, or

H 120, Ø 100



3,3W 340lm



9 002759 945022





94503

LED



94501

LED

94503 POLASSO

ceiling light; aluminium, plastic, white, gold
Deckenleuchte; Alu, Kunststoff, weiss, gold
plafonnier; aluminium, plastique, blanc, or

H 120, Ø 100

LED

3,3W

warm
WHITE

340lm



9 002759 945039

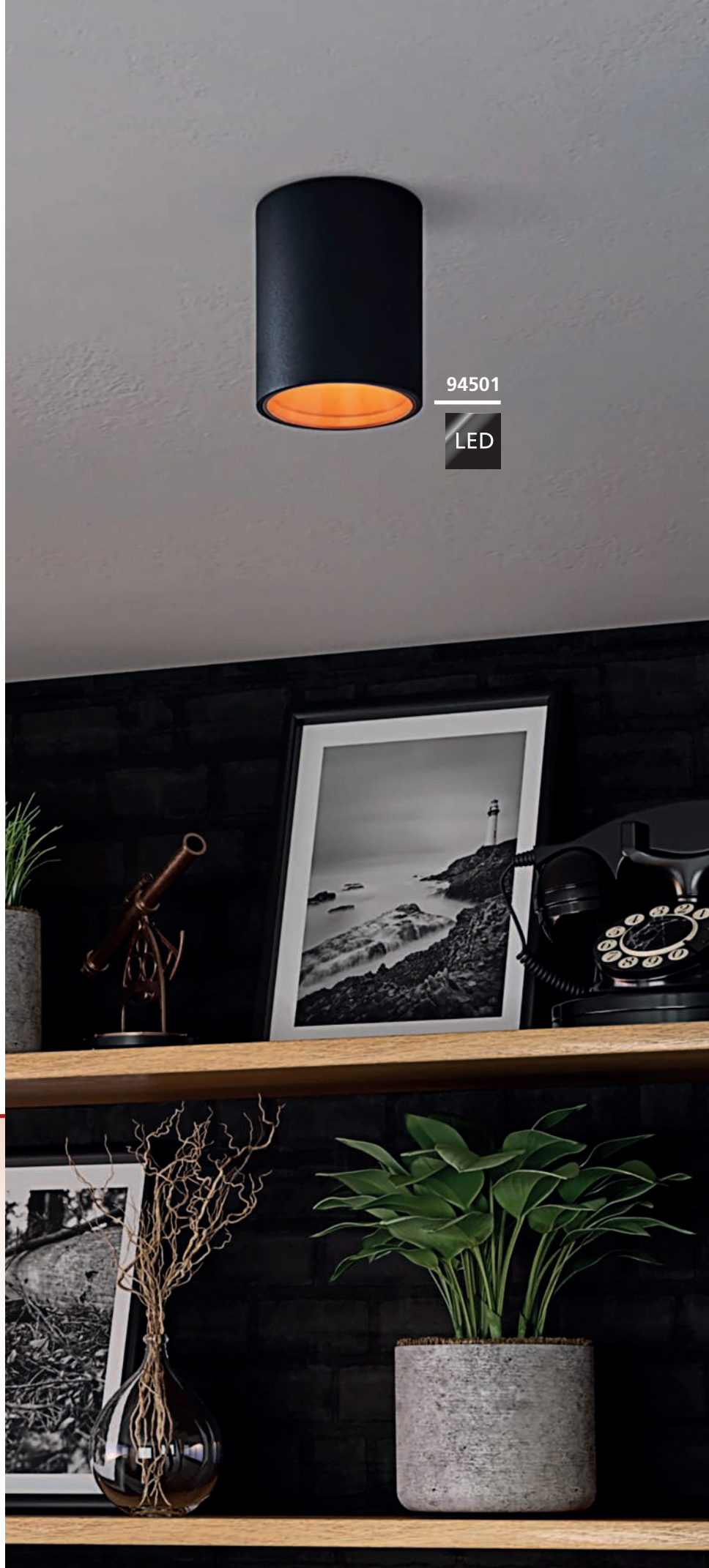



94496

LED



94499

LED



94497

LED

94496 POLASSO

ceiling light; aluminium, plastic, black, copper
Deckenleuchte; Alu, Kunststoff, schwarz, kupfer
plafonnier; aluminium, plastique, noir, cuivre

L 100, B 100, H 120



3,3W 340lm



9 002759 944964

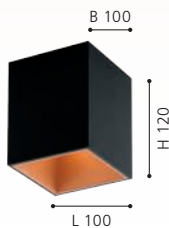

94497 POLASSO

ceiling light; aluminium, plastic, black, gold
Deckenleuchte; Alu, Kunststoff, schwarz, gold
plafonnier; aluminium, plastique, noir, or

L 100, B 100, H 120



3,3W 340lm



9 002759 944971

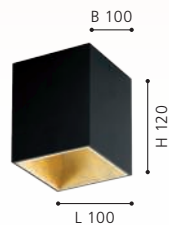

94499 POLASSO

ceiling light; aluminium, plastic, white, silver
Deckenleuchte; Alu, Kunststoff, weiss, silber
plafonnier; aluminium, plastique, blanc, argent

L 100, B 100, H 120



3,3W 340lm



9 002759 944995

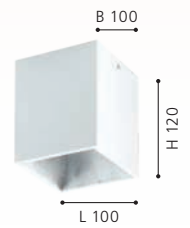



94497

LED

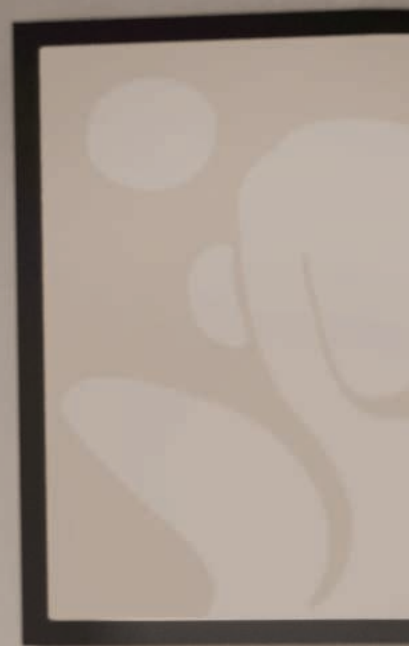

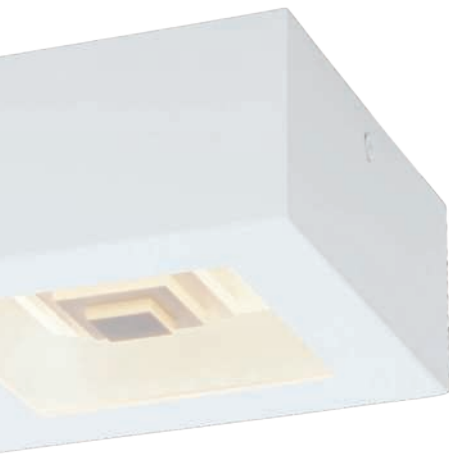

FERREROS

These luminaires have a special leveling effect.

Diese Leuchten besitzen einen besonderen Stufeneffekt.

Ces luminaires ont un effet escalier spécial.

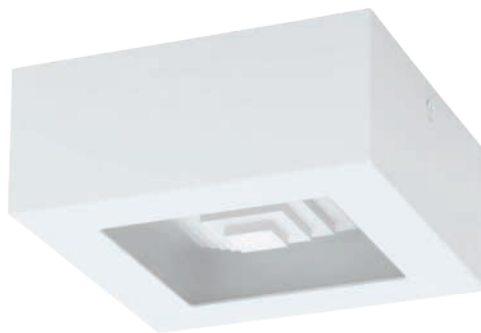

96791

LED

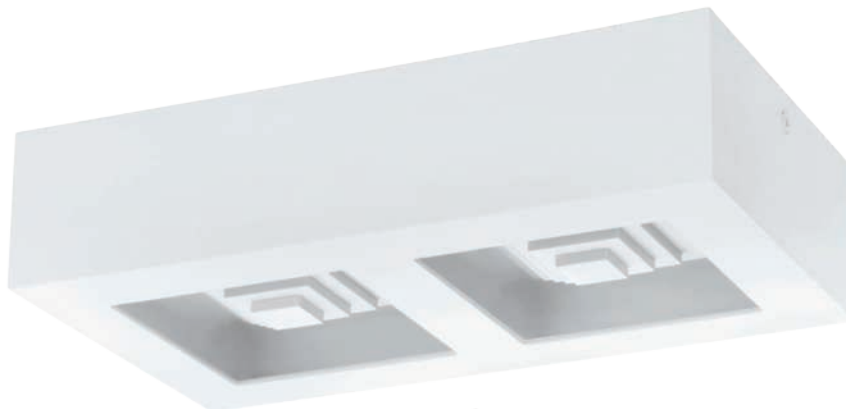

96792

LED

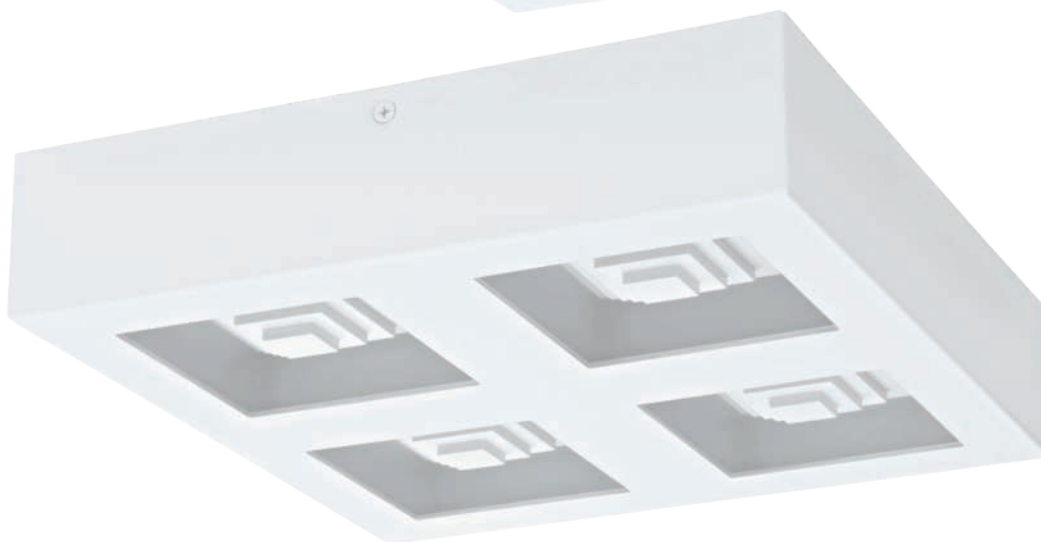

96794

LED

96791 FERREROS

wall/ceiling light; steel, white / plastic, white
Wand- / Deckenleuchte; Stahl, weiss / Kunststoff, weiss
Applique/Plafonnier; acier, blanc / plastique, blanc

L 140, B 140, H 60



1x 6,3W 840lm

96792 FERREROS

wall/ceiling light; steel, white / plastic, white
Wand- / Deckenleuchte; Stahl, weiss / Kunststoff, weiss
Applique/Plafonnier; acier, blanc / plastique, blanc

L 255, B 140, H 60



2x 6,3W 1680lm

96794 FERREROS

wall/ceiling light; steel, white / plastic, white
Wand- / Deckenleuchte; Stahl, weiss / Kunststoff, weiss
Applique/Plafonnier; acier, blanc / plastique, blanc

L 270, B 270, H 60



4x 6,3W 3360lm



9 002759 967918

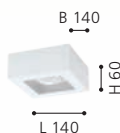

9 002759 967925

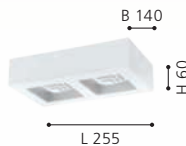

9 002759 967949

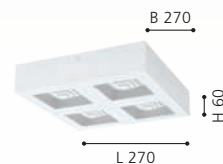

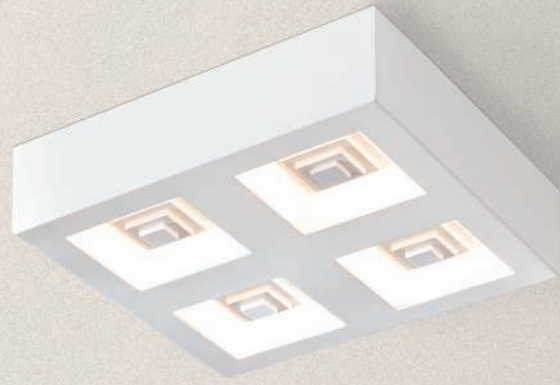

96794

LED





LED STRIPES

ADVANTAGES

- > HOMOGENEOUS LIGHT DISTRIBUTION - IDEAL FOR ILLUMINATING ROOMS AND SURFACES
- > DIFFERENT LIGHT TEMPERATURES:
WARM WHITE/NEUTRAL WHITE AND FUNCTIONS SUCH AS RGB, MOTION SENSOR
- > LOW HEAT GENERATION ENSURES GREATER SAFETY
- > UP TO 80% ENERGY SAVINGS COMPARED TO INCANDESCENT LAMPS, PROTECTING YOUR BUDGET AND THE ENVIRONMENT
- > SIMPLE WIRING THANKS TO INTEGRATED TERMINAL CONNECTION ON THE DRIVER
- > ALL STRIPS HAVE A SELF-ADHESIVE BACKING AND CAN BE CUT TO LENGTH ONCE
- > FREE MOUNTING OR IN LED PROFILE

VORTEILE

- > HOMOGENE LICHTVERTEILUNG – IDEAL ZUR BELEUCHTUNG VON RÄUMEN UND FLÄCHEN
- > VERSCHIEDENE LICHTTEMPERATUREN:
WARMWHITE/NEUTRAL WHITE UND FUNKTIONEN WIE RGB, MOTION SENSOR
- > GERINGE WÄRMEENTWICKLUNG SORGT FÜR MEHR SICHERHEIT
- > BIS ZU 80% STROMERSPARNIS GEGENÜBER GLÜHLAMPEN, SCHONT IHR BUDGET UND DIE UMWELT
- > EINFACHE VERKABELUNG DURCH INTEGRIERTEN KLEMMANSCHLUSS AM TREIBER
- > ALLE STREIFEN MIT SELBSTKLEBENDER RÜCKSEITE UND EINMALIG KÜRZBAR
- > MONTAGE FREI ODER IN LED PROFIL

AVANTAGES

- > RÉPARTITION HOMOGENÈ DE LA LUMIÈRE - IDÉAL POUR L'ÉCLAIRAGE DE PIÈCES ET DE SURFACES
- > DIFFÉRENTES TEMPÉRATURES DE LUMIÈRE :
WARMWHITE/NEUTRAL WHITE ET FONCTIONS TELLES QUE RGB, MOTION SENSOR
- > UN FAIBLE DÉGAGEMENT DE CHALEUR ASSURE UNE PLUS GRANDE SÉCURITÉ
- > JUSQU'À 80% D'ÉCONOMIE D'ÉNERGIE PAR RAPPORT AUX LAMPES À INCANDESCENCE, PRÉSERVE VOTRE BUDGET ET L'ENVIRONNEMENT
- > CÂBLAGE SIMPLE GRÂCE AU RACCORD DE SERRAGE INTÉGRÉ AU DRIVER
- > TOUTES LES BANDES ONT UN VERSO AUTOCOLLANT ET PEUVENT ÊTRE RACCOURCIES UNE SEULE FOIS
- > MONTAGE LIBRE OU DANS UN PROFILÉ LED

OVERVIEW



COB STRIPE
290-291



FLEXIBLE STRIPE
292-296



LED STRIPES-FLEX
296

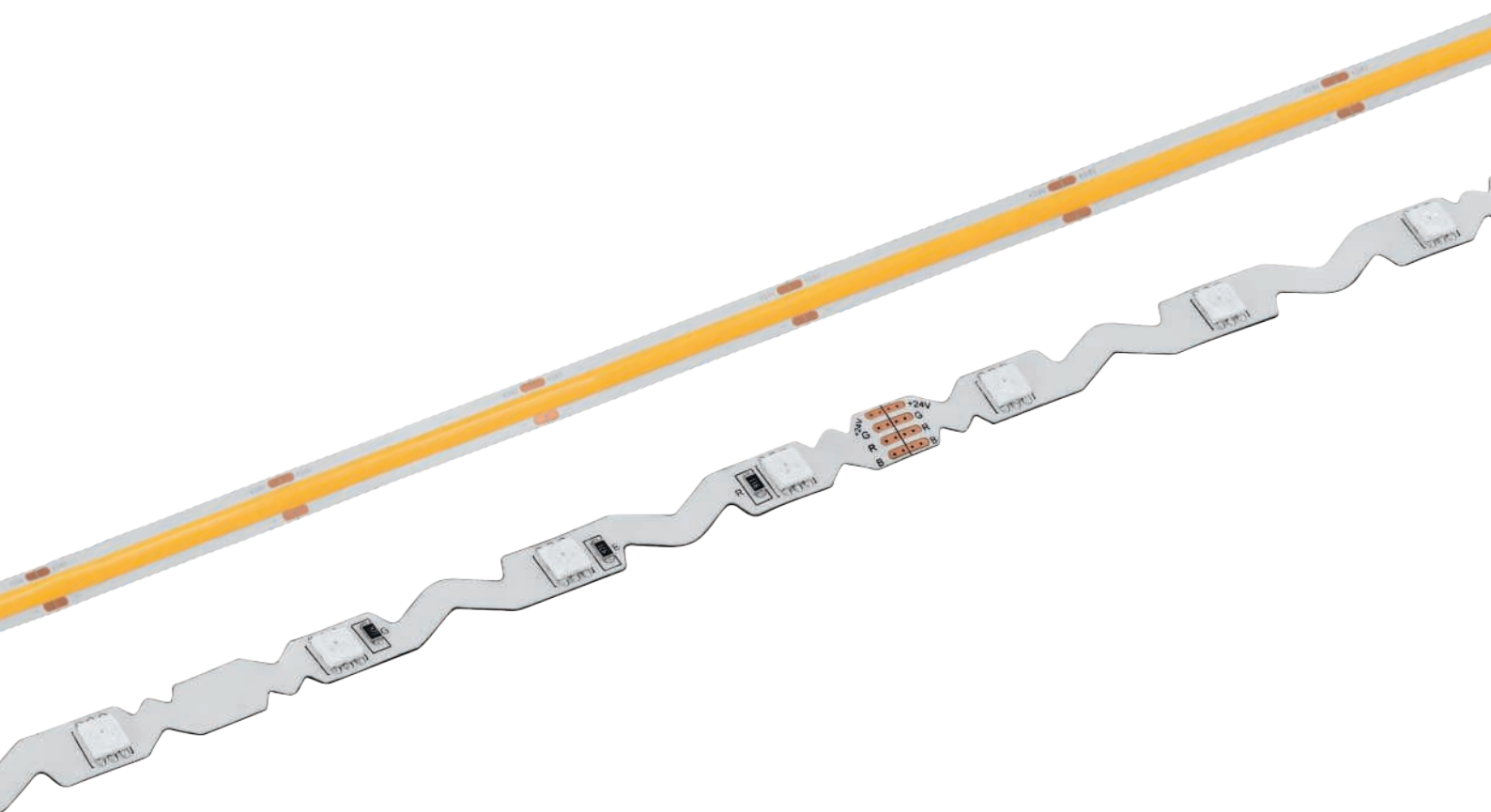

This product is available in different colors and shapes./ Dieser Artikel ist in unterschiedlichen Farben und Formen verfügbar/
Cet article est disponible en différentes couleurs et formes.



LED STRIPES

COB STRIPES

ADVANTAGES

- > PREMIUM LED STRIPS WITHOUT VISIBLE LIGHT POINTS
- > HOMOGENEOUS LIGHT EMISSION ALONG THE ENTIRE LENGTH
- > 480 LEDS/METRE
- > LATEST CHIP ON BOARD (COB) TECHNOLOGY
- > DRIVER INCLUDED

VORTEILE

- > PREMIUM LED-STREIFEN OHNE SICHTBARE LICHTPUNKTE
- > HOMOGENE LICHTABSTRAHLUNG ÜBER DIE GESAMTE LÄNGE
- > 480 LEDS / METER
- > NEUESTE CHIP ON BOARD (COB) TECHNOLOGIE
- > TREIBER INKLUDIERT

AVANTAGES

- > BANDE LED PREMIUM SANS POINTS LUMINEUX VISIBLES
- > ÉMISSION DE LUMIÈRE HOMOGENÈME SUR TOUTE LA LONGUEUR
- > 480 LED/MÈTRE
- > DERNIÈRE TECHNOLOGIE CHIP ON BOARD (COB)
- > PILOTE INCLUS

900574 COB STRIPE

bar/strip light; plastic, white
Leuchtband/-stab; Kunststoff, weiss
bande lumineuse / bâton l; plastique, blanc

L 2000



16W 1400lm



9 008606 244751



L 2000

900575 COB STRIPE

bar/strip light; plastic, white
Leuchtband/-stab; Kunststoff, weiss
bande lumineuse / bâton l; plastique, blanc

L 5000



40W 3500lm



9 008606 244768



L 5000

900576 COB STRIPE

bar/strip light; plastic, white
Leuchtband/-stab; Kunststoff, weiss
bande lumineuse / bâton l; plastique, blanc

L 8000



64W 5600lm



9 008606 244775



L 8000

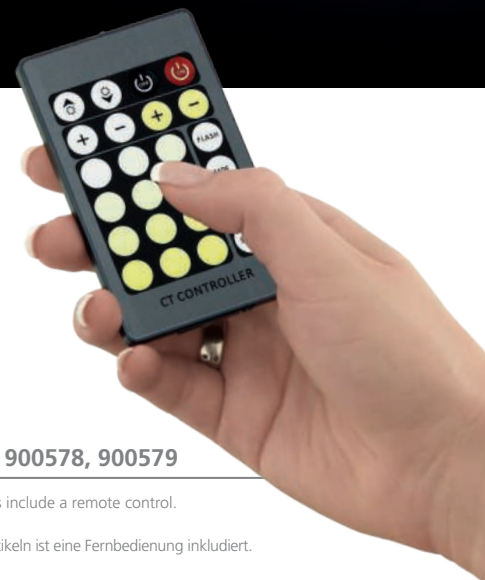

900574

LED

900575

LED

900576

LED



900577

LED

900578

LED

900579

LED

900577, 900578, 900579

These articles include a remote control.

Bei diesen Artikeln ist eine Fernbedienung inkludiert.

Ces articles comprennent une télécommande.

900577 COB STRIPE

bar/strip light; plastic, white
Leuchtband/-stab; Kunststoff, weiss
bande lumineuse / bâton l; plastique, blanc

L 2000



13,2W



1320lm



Remote



L 2000

900578 COB STRIPE

bar/strip light; plastic, white
Leuchtband/-stab; Kunststoff, weiss
bande lumineuse / bâton l; plastique, blanc

L 5000



33W



3300lm



Remote



L 5000

900579 COB STRIPE

bar/strip light; plastic, white
Leuchtband/-stab; Kunststoff, weiss
bande lumineuse / bâton l; plastique, blanc

L 8000



52,8W



5280lm



Remote



L 8000



9 008606 244782



9 008606 244799



9 008606 244805



LED STRIPES

FLEXIBLE STRIPES

ADVANTAGES

- > FREELY FORMABLE
- > SELF-ADHESIVE
- > SEPARABLE EVERY 10 CM
- > OPTIMAL ILLUMINATION EVEN IN CORNERS
- > NO SOLDERING OR INTERMEDIATE PIECE NECESSARY

VORTEILE

- > FREI FORMBAR
- > SELBSTKLEBEND
- > ALLE 10 CM KÜRZBAR
- > OPTIMALE AUSLEUCHTUNG AUCH IN ECKEN
- > KEIN LÖTEN ODER ZWISCHENSTÜCK NOTWENDIG

AVANTAGES

- > SE DÉFORME AISEMENT
- > AUTO-ADHÉSIF
- > PEUT ÊTRE SECTIONNÉ TOUS LES 10 CM
- > UN ÉCLAIRAGE OPTIMAL, MÊME DANS LES COINS
- > PAS DE SOUDURE OU DE PIÈCE INTERMÉDIAIRE NÉCESSAIRE

98571 FLEXIBLE STRIPE

bar/strip light; plastic, white
 Leuchtband/-stab; Kunststoff, weiss
 bande lumineuse / bâton |; plastique, blanc

L 2000, B 6

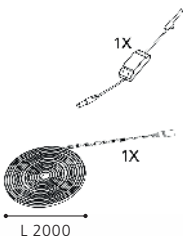

98572 FLEXIBLE STRIPE

bar/strip light; plastic, white
 Leuchtband/-stab; Kunststoff, weiss
 bande lumineuse / bâton |; plastique, blanc

L 5000, B 6

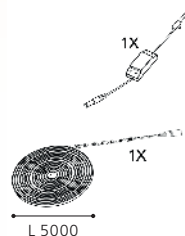

99716 FLEXIBLE STRIPE

bar/strip light; white
 Leuchtband/-stab; weiss
 bande lumineuse / bâton |; blanc

L 8000, B 6

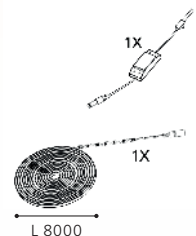



99717 FLEXIBLE STRIPE

bar/strip light; white
Leuchtband/-stab; weiss
bande lumineuse / bâton l; blanc

L 2000, B 6



2x 5,4W 1240lm

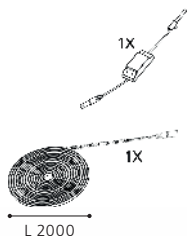

99718 FLEXIBLE STRIPE

bar/strip light; white
Leuchtband/-stab; weiss
bande lumineuse / bâton l; blanc

L 5000, B 6



5x 5,4W 3100lm

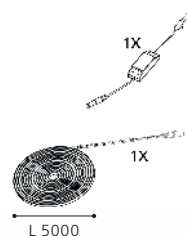

99719 FLEXIBLE STRIPE

bar/strip light; white
Leuchtband/-stab; weiss
bande lumineuse / bâton l; blanc

L 8000, B 8



8x 5,4W 4960lm

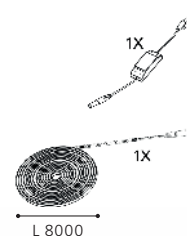



| | | |
|---|--------------|--------------|
|  | 98573 | 98574 |
| RGB | LED | LED |



FLEXIBLE STRIPE

These LED strips are very flexible and are perfect for shaping.

Diese LED-Streifen sind sehr flexibel und eignen sich perfekt zum Formen.

Ces bandes LED sont très flexibles et conviennent parfaitement à la mise en forme.

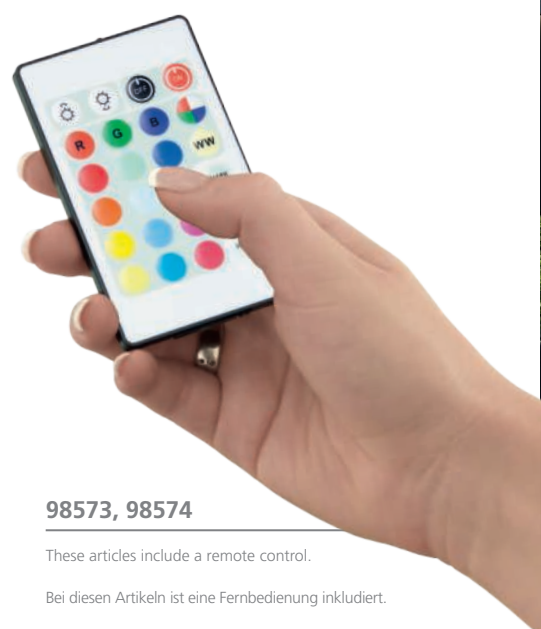

98573, 98574

These articles include a remote control.

Bei diesen Artikeln ist eine Fernbedienung inkludiert.

Ces articles comprennent une télécommande.

98573 FLEXIBLE STRIPE

bar/strip light; plastic, white
 Leuchtband/-stab; Kunststoff, weiss
 bande lumineuse / bâton l; plastique, blanc

L 2000, B 8

| | | | | |
|--|---|---|---|---|
|  |  |  |  |  |
| 9,7W | | | Remote | |

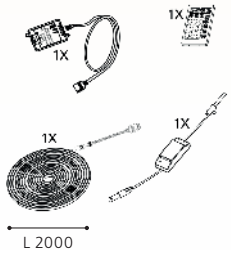

9 002759 985738

L 2000

98574 FLEXIBLE STRIPE

bar/strip light; plastic, white
 Leuchtband/-stab; Kunststoff, weiss
 bande lumineuse / bâton l; plastique, blanc

L 5000, B 8

| | | | | |
|---|---|---|---|---|
|  |  |  |  |  |
| 19,5W | | | Remote | |

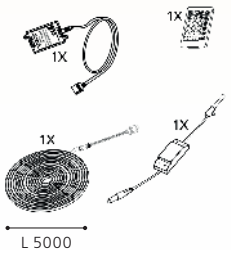

9 002759 985745

L 5000



REMOTE CONTROL

With the aid of the remote control, all LED STRIPES can be dimmed. This note indicates that the remote control is included with the delivery.

Mit Hilfe der Fernbedienung können sämtliche LED-STRIPES gedimmt werden. Bei diesem Hinweis ist die Fernbedienung im Lieferumfang enthalten!

Au moyen de la télécommande, tous les LED STRIPES peuvent être gradués. Avec cette remarque, la télécommande est comprise dans l'étendue de la livraison !



tunable
WHITE
99721
99722
99723
LED
LED
LED



99721, 99722, 99723

These articles include a remote control.
 Bei diesen Artikeln ist eine Fernbedienung inkludiert.
 Ces articles comprennent une télécommande.

99721 FLEXIBLE STRIPE

bar/strip light; white
 Leuchtband/-stab; weiss
 bande lumineuse / bâton l; blanc

L 2000, B 8



2x 4,6W

960lm



L 2000

99722 FLEXIBLE STRIPE

bar/strip light; white
 Leuchtband/-stab; weiss
 bande lumineuse / bâton l; blanc

L 5000, B 8



5x 4,6W

2400lm



L 5000

99723 FLEXIBLE STRIPE

bar/strip light; white
 Leuchtband/-stab; weiss
 bande lumineuse / bâton l; blanc

L 8000, B 8



8x 4,6W

3840lm



L 8000

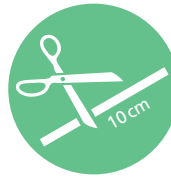
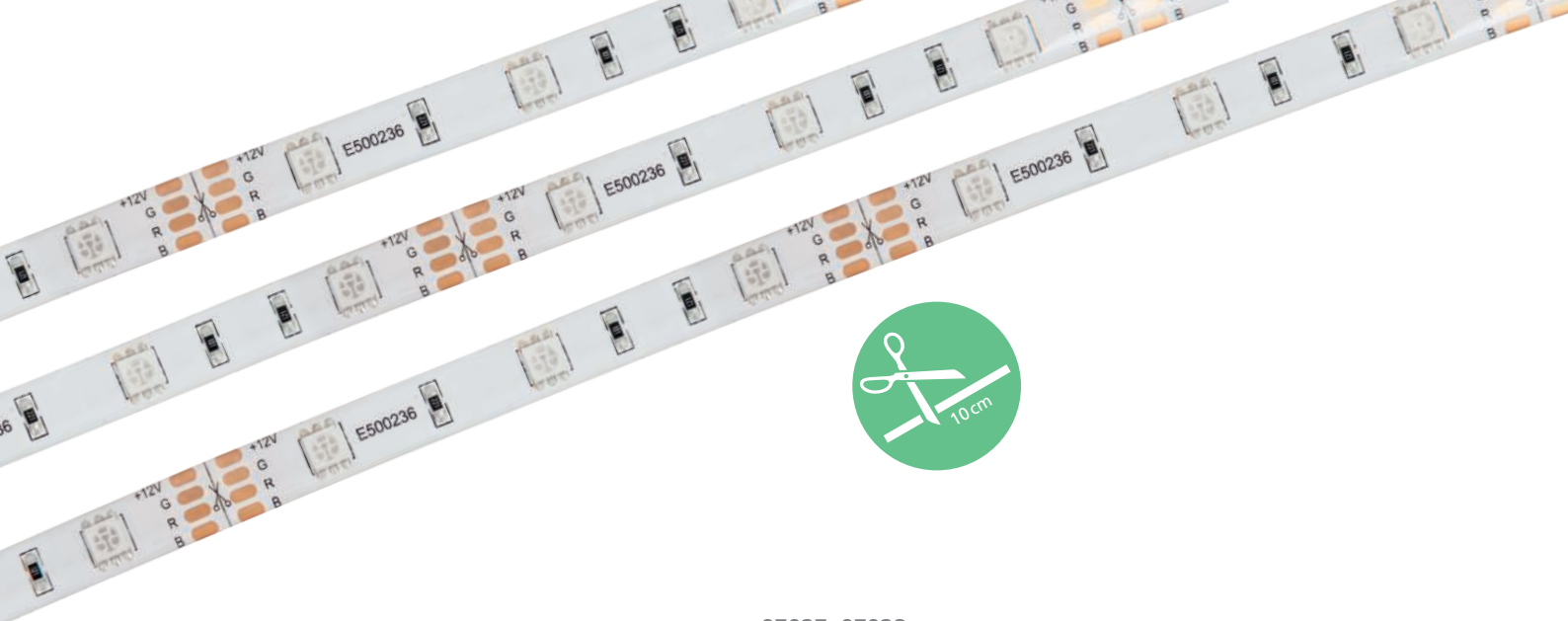

97927, 97928

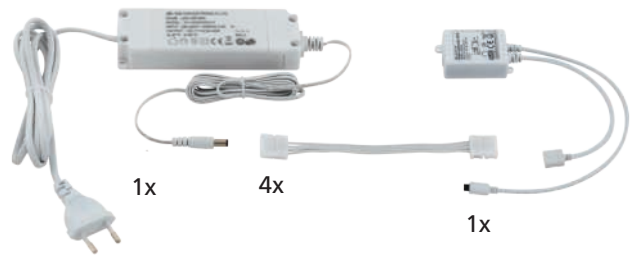

1x

4x

1x

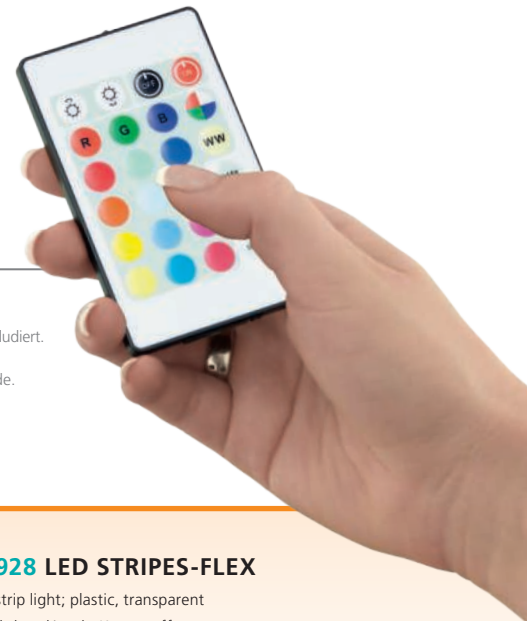

99724, 97927, 97928

These articles include a remote control.

Bei diesen Artikeln ist eine Fernbedienung inkludiert.

Ces articles comprennent une télécommande.

99724 FLEXIBLE STRIPE

bar/strip light; white
Leuchtband/-stab; weiss
bande lumineuse / bâton l; blanc

L 8000, B 8



38,4W

Remote



9 002759 997243



L 8000

97927 LED STRIPES-FLEX

bar/strip light; plastic, transparent
Leuchtband/-stab; Kunststoff, transparent
bande lumineuse / bâton l; plastique, transparent

L 2000, B 10, H 3



10W

760lm

Remote



10



9 002759 979270



L 2000

97928 LED STRIPES-FLEX

bar/strip light; plastic, transparent
Leuchtband/-stab; Kunststoff, transparent
bande lumineuse / bâton l; plastique, transparent

L 5000, B 10, H 3



20W

1900lm

Remote



10



9 002759 979287



L 5000



97927



97928



EGLO WORLDWIDE

EGLO WELTWEIT / EGLO DANS LE MONDE



 **AUSTRIA**
EGLO LEUCHTEN GMBH

Heiligkreuz 22
6136 Pill
T: +43 5242 6996 110 | F: +43 5242 6996 972
info-austria@eglo.com

 **CHILE**
EGLO CHILE ILUMINACIÓN LTDA.

Av. Américo Vespucio Norte 1930
Conchalí - Santiago de Chile
T: +562 2 595 2222
info-chile@eglo.com

 **DENMARK**
EGLO DANMARK A/S

Agerbakken 20
8362 Hørning
T: +45 70 22 55 11
info-denmark@eglo.com

 **AUSTRALIA**
EGLO LIGHTING AUSTRALIA

5/339 Archerfield Road
4077 Richlands | Queensland
T: +61 7 3375 1413 | F: +61 7 3375 1412
info@eglolighting.com.au

 **CHINA**
DONGGUAN EGLO LIGHTING
COMMERCIAL CO LTD

No.1 | Shangqiao Industrial Rd Shangqiao, Dongcheng
Dongguancity, Guanzhouprovince
T: +86 769 2203 3866 | F: +86 769 2203 6866
info-china@eglo.com

 **ESTONIA**
MOODNE VALGUSTUS AS

Rävala pst. 7
10143 Tallinn
T: +372 667 6670 | F: +372 631 3195
info-estonia@eglo.com

 **BELGIUM**
EGLO BELGIUM BV

Antwerpsesteenweg 247
2950 Kapellen
T: +32 3 250 60 80 | F: +32 3 219 80 67
info-belgium@eglo.com

 **COLOMBIA**
EGLO COLOMBIA ILUMINACIÓN SAS

Autopista Norte 800 Mts adelante del Peaje de los Andes
Costado Oriental Km 19 Lote 30
Bogotá - Chia
T: +57 (1) 744 2339
info-colombia@eglo.com

 **FINLAND**
EGLO FINLAND OY

Malmi raitti 17A
00700 Helsinki
T: +358 20 7649 820
info-finland@eglo.com

 **BOSNIA AND HERZEGOVINA**
EGLO RASVIJETA BH D.O.O.

Hrgovi Donji 178
76250 Gradacac
T: +387 35 86 85 00 | F: +387 35 82 44 41
info-Bosnia-Herzegovina@eglo.com | info@eglo.ba

 **COSTA RICA**
EGLO COSTA RICA

Centro Comercial Calle Real local #8 de la sucursal del
BAC San José 800 metros al norte Guachipilín de Escazú
San José, Costa Rica
T: +506-2289-4690 | F: +506-2100-6384
info-costarica@eglo.com

 **FRANCE**
EGLO FRANCE LUMINAIRE SARL

Z.A. Jeune Bois | 2 Rue de la Martinique
68274 Wittenheim
T: +33 3 89 62 50 45 | F: +33 389 6250 49
info-france@eglo.com

 **BULGARIA**
EGLO BULGARIA EOOD

Main Road Burgas-Sofia | 5th kilometer | Building EGLO
8000 Burgas
T: +359 888 755 509
info-bulgaria@eglo.com

 **CROATIA**
EGLO RASVIJETA D.O.O.

Jadranska avenija 9
10020 Zagreb
T: +385 1 379 40 62 | F: +385 1 379 41 04
info-croatia@eglo.com

 **GERMANY**
EGLO LEUCHTEN HANDELS GMBH

Kleinbahnstr. 35
59759 Arnsberg
T: +49 2932 6269 0 | F: +49 2932 6269 39
info-germany@eglo.com

 **CANADA**
EGLO CANADA INC.

20700 Route Transcanadienne
H9X 4B7 Baie D'Ufré, Quebec
T: +1 514 457 5483 | F: +1 514 457 5487
info-canada@eglo.com

 **CZECH REPUBLIC**
EGLO CZ+SK s.r.o.

Náchodská 2479/63
193 00 Praha 9
T: +420 281 924 163 | F: +420 281 925 205
info-czechrepublic@eglo.com

 **GREAT BRITAIN AND IRELAND**
EGLO UK LTD.

54 Denington Rd, Denington Industrial Estate
Wellingborough NN8 2QH, UK
T: +44 1604 790 986
info-UK@eglo.com

**GREECE**

EGLO HELLAS A.E.

Sykias 2 and parodos dekeleias
13679 Acharnai
T: +30 21 0800 2363
info-greece@eglo.com

**HUNGARY**

EGLO LUX KFT.

Fő út 143/A
2120 Dunakeszi
T: +36 27 341 353
info-hungary@eglo.com

**INDIA**

EGLO INDIA PRIVATE LIMITED

A-307, Ansal Chambers - 1, 3, Bhikaji Cama Place,
110066 Delhi
T: +91 85279 44288
info-india@eglo.com

**ITALY**

EGLO ITALIANA S.R.L.

Via Giotto, 4
31021 Mogliano Veneto (TV)
T: +39 041 45 66 245 | F: +39 041 45 74 066 / 071
info-italy@eglo.com

**KAZAKHSTAN**

EGLO KAZAKHSTAN LLP

Al-Farabi Avenue 7, Office 72, 14rd floor, Block 4A,
Nurly-Tau Business Center
50059 Almaty
T: +7 727 293 25 20 | M: +7 701 031 00 00
info-kazakhstan@eglo.com

**KOSOVO**

EGLO KOSOVA LLC

Lugisht e qytetit pn
20000 Prizren
T: +383 44 216 687 | SHOP: +383 49 699 100
info-kosovo@eglo.com

**LATVIA**

MOODNE VALGUSTUS AS

Rāvala pst.7
10143 Tallinn
T: +370 652 49923 | T: +372 667 6670
info-latvia@eglo.com

**LITHUANIA**

MOODNE VALGUSTUS AS

Rāvala pst.7
10143 Tallinn
T: +370 652 49923 | T: +372 667 6670
info-lithuania@eglo.com

**MALAYSIA**

EGLO ASIA SDN BHD

B-07-13, Empire Soho, Empire Subang, Jalan SS 16/1,
47500 Subang Jaya, Selangor Darul Ehsan.
T: +60162115313
info-malaysia@eglo.com

**MEXICO**

EGLO MÉXICO ILUMINACIÓN S DE RL DE CV

Prolongación Avenida López Mateos Sur N°3561,
Fraccionamiento Los Gavilanes
C.P. 45645 Tlajomulco de Zúñiga | Jalisco
T: +52 33 3687 20 95
info-mexico@eglo.com

**MIDDLE EAST**

EGLO LIGHTING MIDDLE EAST FZE

P.O. BOX 262073, LOB6, OFFICE G18
Jebel Ali, Dubai, UAE
T: +97 148810080 | F: +97 148810081
gulf@eglo.com

**MOROCCO - EGLO AFRICA**

EGLO MAGHREB LUMINAIRES SARL

219 Bd Med Zerkoutouni. Suite: 67
20230 Casablanca
T: +212 522 98 80 25 / -05
info-global@eglo.com | info.africa@eglo.com

**THE NETHERLANDS**

EGLO VERLICHTING NEDERLAND B.V.

Innovatiepark 20
4906 AA Oosterhout (NB)
T: +31 162 48 28 30
info-nl@eglo.com

**NORWAY**

MS BELYSNING

Gardermovegen 95B
2030 Nannestad
T: +47 63 888500 | F: +47 63 888501
info-norway@eglo.com

**PERU**

EGLO PERU S.A.C

Av Primavera 1419
Distrito de Santiago de Surco y Departamento de Lima
T: +51 902 763 635
info-peru@eglo.com

**POLAND**

EGLO POLSKA SP. Z O.O.

Ul. Dżwiękowa 2
02-857 Warszawa
T: +48 22 644 57 55 | T: +48 22 644 89 82
info-poland@eglo.com

**PORTUGAL**

EGLO PORTUGAL ILUMINAÇÃO, LDA

Rua Fonte Parada, 125
4595-434 Seroa-Paços de Ferreira
T: +351 255 890 000
info-portugal@eglo.com

**ROMANIA**

EGLO ROMANIA PRODEXIM SRL.

Str. Atomistilor nr. 1D
77125 Magurele - Ilfov
T: +40 314 250 902 | F: +40 314 250 899
info-romania@eglo.com

**RUSSIA**

EGLO LIGHTING LLC

Varshavskoe shosse 3 | Office 23
117105 Moscow
T: +7495 789 4311 | F: +7495 789 4312
info-russia@eglo.com

**SERBIA**

EGLO RASVETA DOO

Stefana Prvovenčanog 28
11000 Beograd
T: +381 11 3981 366 | F: +381 11 3981 389
info-serbia@eglo.com

**SLOVAKIA**

EGLO CZ+SK s.r.o

Náchodská 2479/63
193 00 Praha 9
T: +421 313 211 551 | F: +421 313 211 556
info-slovakia@eglo.com

**SLOVENIA**

EGLO RASVJETA D.O.O.

Jadranska avenija 9
10020 Zagreb
T: +386 158 093 18
info-slovenia@eglo.com

**SPAIN**

EGLO ESPANA ILUMINACIÓN S.L.

Avda. de Castilla,1 (Edif. Best Point) 2º Planta - Oficina
16A-B
28830 San Fernando de Henares, Madrid
T: +34 91 677 90 44 | F: +34 91 677 03 04
info-spain@eglo.com

**SWEDEN**

EGLO SVRIGE AB

Star Street 1
512 50 Svenljunga
T: +46 340 623 505
info-sweden@eglo.com

**SWITZERLAND**

EGLO SCHWEIZ AG

Seetalstrasse 142
6032 Emmen
T: +41 41 268 69 59
info-switzerland@eglo.com

**TURKEY**

EGLO Aydınlatma ithalat ihracat Ltd. Şti.

Eyüp Sultan Mah. Sekmen Cad. No:18/2
34885 Sancaktepe / Istanbul Samandıra
T: +90 216 311 09 -02 / -03 / -04 |
F: +90 216 311 09 / -05
info-turkey@eglo.com

**UKRAINE**

EGLO UKRAINE LTD

Vatslava Gavela boulevard, 6/7-A,
03124 Kyiv
T: +38 067 670 58 61
info-ukraina@eglo.com

**USA**

EGLO USA, INC.

3640 Royal South Parkway
30349 Atlanta, Georgia
T: +1 404 477 5601 | F: +1 404 393 7053
info-usa@eglo.com

HOW TO READ

ERKLÄRUNG
COMMENT LIRE

ARTICLE NUMBER & SERIES NAME
ARTIKELNUMMER & SERIENNAME
NUMÉRO D'ARTICLE & NOM DE LA SÉRIE

DIMENSIONS
DIMENSIONEN
DIMENSIONS

all dimensions in mm | alle Größen in mm | toutes dimensions en mm

L = length | Länge | longueur

B = width | Breite | largeur

H = height | Höhe | hauteur

Ø = diameter | Durchmesser | diamètre

A = projection length | Ausladung | amplitude

ET = installation depth | Einbautiefe | profondeur utile

Base = base dimensions | Sockelmaße | dimensions de base

Attention! The dimensions relate solely to the sizes of the luminaire. Any air spaces that would be relevant for a safe operating of the lamp were not considered.

Achtung! Die Größen beziehen sich nur auf die Abmessungen der Leuchte. Etwaige Lufträume, die für einen sicheren Betrieb der Leuchte notwendig sind, werden nicht berücksichtigt.

Attention! Les dimensions se réfèrent à la taille de la lampe seulement. Espacements éventuels, que seraient importants pour une opération de la lampe sans danger, n'ont pas été considérés.

PICTOGRAMMES
PIKTOGRAMME
PIKTOGRAMMES

Technical details are represented as pictograms. An overview over all pictograms can be found on the next pages.

Technische Details werden als Piktogramme dargestellt. Eine Übersicht über alle Piktogramme finden Sie auf den nächsten Seiten.

Les détails techniques sont représentés sous forme de pictogrammes. Vous trouverez un aperçu de tous les pictogrammes dans les pages suivantes.

BUTTONS
BOUTONS
BOUTONS

Bulb included
Leuchtmittel inkludiert
ampoules inclus 

Recessed Luminaire
Einbauleuchte
luminaire encastrable 

Surface Luminaire
Aufbauleuchte
luminaire en saillie 

DESCRIPTION
BESCHREIBUNG
DESCRIPTION

The product description is composed as follows:
luminaire type; enclosure material, enclosure colour / glass or shade material, glass or shade colour

Die Produktbeschreibung setzt sich wie folgt zusammen:
Leuchtenart; Gehäusematerial, Gehäusefarbe / Schirm- bzw. Glasmaterial, Schirm- bzw. Glasfarbe

La description du produit est composée comme suit:
type de luminaire; matériel de boîtier, couleur de boîtier / matériel de verre ou abat-jour, couleur de verre ou abat-jour

SKETCHES
SKIZZEN
CROQUIS

The sketches state the most meaningful dimensions. If a product is adjustable by will, a turquoise arrow marks this function and only the maximum dimensions are indicated.

Die Bemaßung der Skizzen umfasst jeweils die aussagekräftigsten Größen. Bei verstellbaren Produkten kennzeichnet ein türkiser Pfeil diese Funktion und nur die maximalen Größen werden angegeben.

Les dimensions des croquis comprennent les plus représentatives. Si un produit est réglable au choix, une flèche turquoise affiche cette fonction et rien que les dimensions maximales sont indiquées.

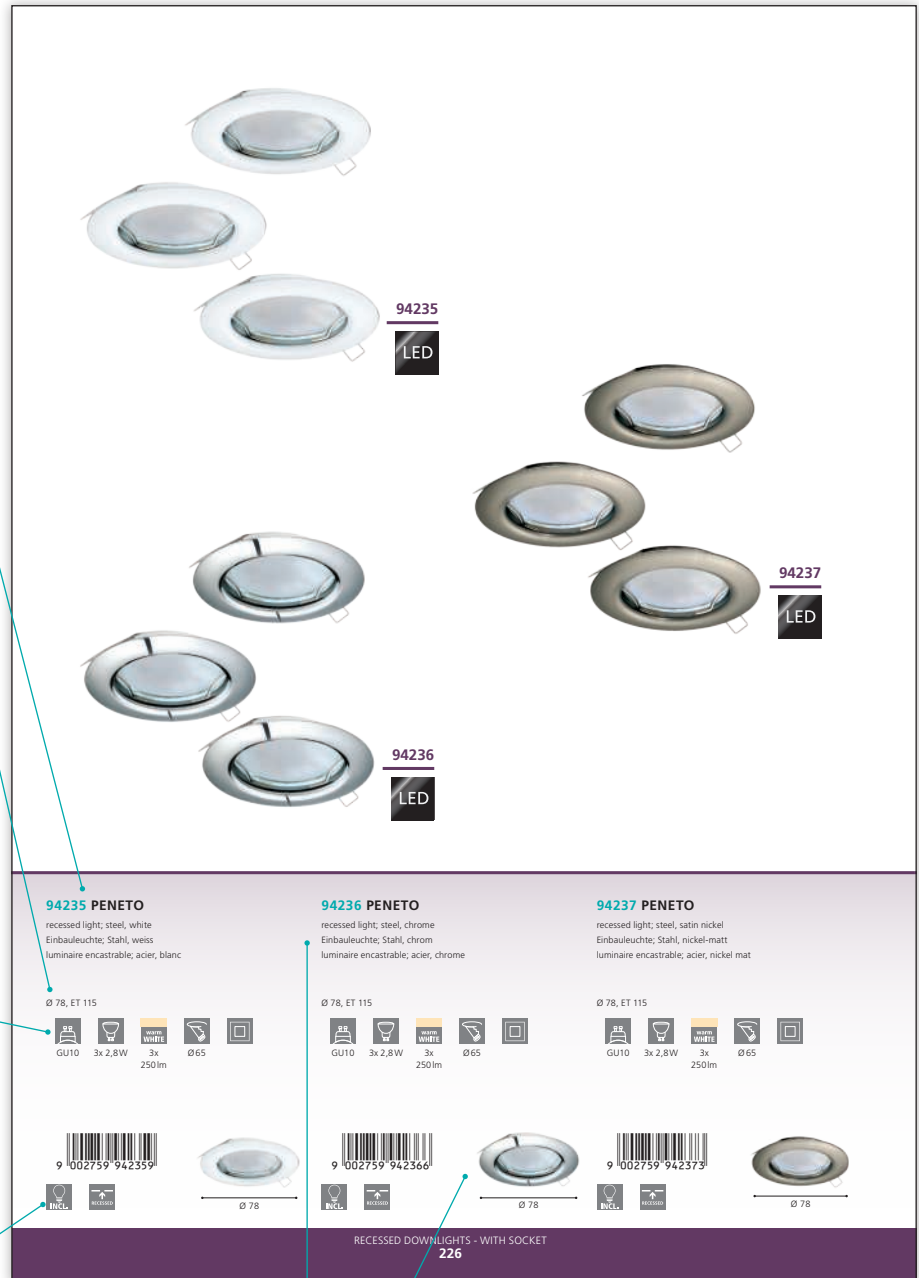

94235 PENETO
recessed light; steel, white
Einbauleuchte; Stahl, weiss
luminaire encastrable; acier, blanc
Ø 78, ET 115
GU10 3x 2,8W 3x 250lm Ø65

94236 PENETO
recessed light; steel, chrome
Einbauleuchte; Stahl, chrom
luminaire encastrable; acier, chrome
Ø 78, ET 115
GU10 3x 2,8W 3x 250lm Ø65

94237 PENETO
recessed light; steel, satin nickel
Einbauleuchte; Stahl, nickel-matt
luminaire encastrable; acier, nickel mat
Ø 78, ET 115
GU10 3x 2,8W 3x 250lm Ø65

RECESSED DOWNLIGHTS - WITH SOCKET
226

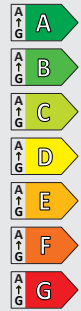
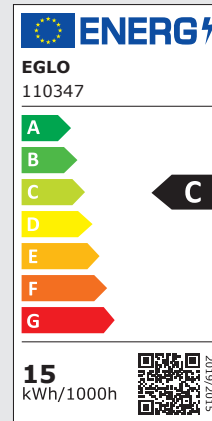

FUEVA 5
Ø 166, ET 26
recessed light
Einbauleuchte
luminaire encastrable



| Material / Colour | Size | Cutout | Watt | Lumen | IP class | Item no. | EAN code |
|--|--------------|--------|------|--------|----------|----------|-----------------|
| steel, white / plastic, white Stahl, weiss / Kunststoff, weiss acier, blanc / plastique, blanc | Ø 166, ET 26 | Ø 155 | 11W | 1350lm | | 99133 | 9 002759 991333 |
| | Ø 166, ET 26 | Ø 155 | 11W | 1350lm | | 99192 | 9 002759 991920 |
| | Ø 166, ET 26 | Ø 155 | 11W | 1350lm | IP44 | 99203 | 9 002759 992033 |
| | Ø 166, ET 26 | Ø 155 | 11W | 1350lm | | 99149 | 9 002759 991494 |
| | Ø 166, ET 26 | Ø 155 | 11W | 1350lm | IP44 | 99207 | 9 002759 992071 |
| steel, satin nickel / plastic, white Stahl, nickel-matt / Kunststoff, weiss acier, nickel mat / plastique, blanc | Ø 166, ET 26 | Ø 155 | 11W | 1350lm | | 99138 | 9 002759 991388 |
| | Ø 166, ET 26 | Ø 155 | 11W | 1350lm | | 99154 | 9 002759 991548 |
| steel, chrome / plastic, white Stahl, chrom / Kunststoff, weiss acier, chrome / plastique, blanc | Ø 166, ET 26 | Ø 155 | 11W | 1350lm | IP44 | 99205 | 9 002759 992057 |
| | Ø 166, ET 26 | Ø 155 | 11W | 1350lm | IP44 | 99209 | 9 002759 992095 |
| steel, black / plastic, white Stahl, schwarz / Kunststoff, weiss acier, noir / plastique, blanc | Ø 166, ET 26 | Ø 155 | 11W | 1350lm | | 99144 | 9 002759 991449 |
| | Ø 166, ET 26 | Ø 155 | 11W | 1350lm | IP44 | 99212 | 9 002759 992125 |
| | Ø 166, ET 26 | Ø 155 | 11W | 1350lm | | 99158 | 9 002759 991586 |
| | Ø 166, ET 26 | Ø 155 | 11W | 1350lm | IP44 | 99214 | 9 002759 992149 |

RECESSED DOWNLIGHTS - FUEVA
245

TABLE
TABELLE
TABLEAU

Some products have the same appearance and only differ in terms of technical data or functions such as light colour, dimmability, IP class, etc. These are shown in a table for a better overview.

Einige Produkte haben die selbe Optik und unterscheiden sich nur durch technische Daten oder Funktionen wie: Lichtfarbe, Dimmbarkeit, IP-Klasse, etc. Diese werden für den besseren Überblick in einer Tabelle dargestellt.

Certains produits ont la même apparence et ne diffèrent qu'en termes de données techniques ou de fonctions, telles que la couleur de la lumière, la possibilité de gradation, la classe IP, etc. Pour une meilleure vue d'ensemble, ils sont présentés dans un tableau.

The new energy label must be indicated on all light sources with a luminous flux between 60 and 82,000 lumens and LED. This applies to lamps, LED modules and luminaires where the light source cannot be removed without destroying it.

Das neue Energielabel muss auf allen Lichtquellen mit einem Lichtstrom zwischen 60 und 82.000 Lumen und LED angegeben werden. Dies gilt für Lampen, LED-Module und Leuchten, bei denen die Lichtquelle nicht zerstörungsfrei entnommen werden kann.

Le nouveau label énergétique doit être indiqué sur toutes les sources lumineuses dont le flux lumineux est compris entre 60 et 82 000 lumens et sur les LED. Cela s'applique aux lampes, aux modules LED et aux luminaires dont la source lumineuse ne peut être retirée sans être détruite.

The information on the label includes: / Die Angaben auf dem Etikett beinhalten: / Les informations figurant sur l'étiquette sont les suivantes :

- › Name/Trademark
Name/Warenzeichen
Nom/marque de commerce
- › Model / Modell / Modèle
- › Energy label scale A-G / Energielabel-Skala A-G / Échelle d'étiquetage énergétique A-G
- › Energy consumption for 1,000 hours of use/
Energieverbrauch bei 1.000 Stunden Nutzung/
Consommation d'énergie pour 1 000 heures d'utilisation
- › Energy efficiency class of the product/
Energieeffizienzklasse des Produkts/
Classe d'efficacité énergétique du produit
- › QR Code to EPREL (Product Database of the European Product Registry for Energylabelling)/
QR Code zur EPREL (Produktdatenbank der European Product Registry for Energylabelling)/
Code QR pour EPREL (base de données des produits du registre européen des produits pour l'étiquetage énergétique)

The energy spectrum ranges from G to A.
Das Energiespektrum reicht von G bis A.

Le spectre énergétique va de G à A.



















LEGEND

PICTOGRAM















































PIKTOGRAMME

PICTOGRAMME

SOCKETS FASSUNGEN DOUILLES

| | | |
|--|--|--|
|  LED |  G4 |  G53 |
|  2G7 |  G5 |  GU5,3 / MR16 |
|  2G11 |  G9 |  GU10 |
|  2GX13 |  G10Q |  GX53 |
|  E14 |  G13 |  GY6,35 |
|  E27 |  G23 |  R7s |

BULBS LEUCHTMITTEL AMPOULES

| | | |
|--|--|---|
|  E14 / C35 |  E27 / A60 Halogen |  E27 / E140 Filament |
|  E14 / C35f |  E27 / R63 Halogen |  E27 / PS160 Filament |
|  E14 / D45 |  E27 / A60 LED |  E27 / T30 Filament |
|  E14 / C35f LED |  E27 / A60 Filament |  E27 / T32 Filament |
|  E14 / D45 Halogen |  E27 / A65 LED |  G4 / T9 |
|  E14 / C35 Halogen |  E27 / A75 Filament |  G4 / LT9 |
|  E14 / T22 |  E27 / G45 LED |  G4 / LT14 |
|  E14 / C35 Filament |  E27 / G45 Filament |  G9 |
|  E14 / C37 Filament |  E27 / G80 Filament |  G9 LED |
|  E14 / C35f Filament |  E27 / G95 |  GU10 |
|  E14 / C37f Filament |  E27 / G95 Filament |  GU10 LED |
|  E14 / P45 LED |  E27 / G125 |  GU10 SMD LED |
|  E14 / P45 Filament |  E27 / G95 LED |  GX53 / LF75 |
|  E14 / P50 |  E27 / G200 Filament | LED LED board / LED Platine / LED bord |
|  E14 / ST48 Filament |  E27 / R63 LED |  MR16 |
|  E14 / ST64 Filament |  E27 / ST48 Filament |  MR16 LED |
|  E14 / T20 LED |  E27 / ST64 Filament |  R7s / 78mm |
|  E27 / A60 |  E27 / B80 Filament |  R7s / 118mm |
|  E27 / G90 |  E27 / BR150 Filament |  R7s / 78mm LED |
|  E27 / QR63 |  E27 / DP165 Filament |  R7s / 118mm LED |

LIGHT COLOUR & LUMEN
LICHTFARBE & LUMEN
COULEUR LUMINEUX & LUMEN

The colours of the LED are represented as pictogrammes (see below), their luminous flux directly beneath. The luminous flux is quoted in lumen and describes the amount of light generated by the LED. The higher the value, the brighter is the lamp. Lumens are LED boards and are the light measurement value in bulbs.

Die Farben der LED werden als Piktogramm (siehe unten) dargestellt, deren Lichtstrom direkt darunter. Der Lichtstrom wird in Lumen gemessen und gibt die erzeugte Lichtmenge der LED an. Je höher der Wert, desto heller das Produkt. Lichtstromangaben (Lumen) sind Platinen- bzw. Leuchtmittelwerte.

Les couleurs de LED ont représentés sous forme de pictogrammes, leur flux lumineux directement en dessous. L'unité de flux lumineux est le lumen et il mesure la quantité de lumière générée par les LED. Plus la valeur est élevée, plus la lampe est lumineuse. Les lumens sont l'unité de mesure de l'intensité lumineuse des ampoules et des panneaux led intégrés.

| | |
|--|---|
| | RGB RGB RGB |
| | RGB + white RGB + weiß RGB + blanc |
| | RGB + warmwhite RGB + warmweiß RGB + blanc chaud |
| | RGB + coldwhite RGB + kaltweiß RGB + blanc froid |
| | RGB + neutralwhite RGB + neutralweiß RGB + blanc neutrale |

| | |
|--|---|
| | RGB + tunable white RGB + tunable white RGB + tunable white |
| | tunable white tunable white tunable white |
| | warm white warmweiß blanc chaud |
| | cold white kaltweiß blanc froid |
| | neutral white neutralweiß blanc neutre |

SWITCHES & SENSORS
SCHALTER & SENSOREN
INTERRUPTEUR & CAPTEURS

| | |
|--|--|
| | incl. cable & plug inkl. Kabel & Stecker câble & connecteur inclus |
| | internal dimmer eingebauter Dimmer variateur intégré |
| | button switch Druckknopf interrupteur de pression |
| | function switch Funktionsschalter interrupteur fonction |
| | rocker switch Wippschalter interrupteur à bascule |
| | pedal dimmer Trittdimmer variateur à pied |

| | |
|--|--|
| | pedal switch Trittschalter interrupteur à pied |
| | cable switch Kabelschalter interrupteur à câble |
| | incl. cable & plug transformer inkl. Kabel & Stecktransformator câble & transformateur à prise |
| | remote control Fernbedienung télécommande |
| | Day & Night Sensor Tag & Nacht Sensor sensor jour & nuit |
| | sensor Sensor sensor |

| | |
|--|--|
| | swedish plug Stecker Schweden connecteur swede |
| | "Touch me" ON/OFF "Touch me" EIN/AUS "Touch me" ON/OFF |
| | "Touch me" ON/OFF & dimm "Touch me" EIN/AUS & Dimmen "Touch me" ON/OFF & graduable |
| | pull switch Zugschalter interrupteur à bascule |
| | Timer - automatic on/off Zeitschaltuhr - automatisches Ein- & Ausschalten minuterie - peut être éteint et allumé automatiquement |

FUNKTIONS & COMFORT
FUNKTIONEN & KOMFORT
FONCTIONS & COMFORT

| | |
|--|---|
| | incl. battery inkl. Akku incl. pile |
| | incl. battery inkl. Batterie incl. pile |
| | battery specifications Batteriespezifikationen spécifications des piles |
| | beam angle Ausstrahlwinkel angle de rayonnement |
| | corner mount possible Eckmontage möglich montage en coin possible |
| | CRI Colour Rendering Index |

| | |
|--|--|
| | cutout (in mm) Ausschnitt (in mm) perçage du panneau (en mm) |
| | dimmable dimmbar mit externen Dimmer graduable |
| | not dimmable nicht dimmbar ne pas graduable |
| | Can be operated via control unit Bedienbar über Steuergerät Peut être commandé par une unité de contrôle |
| | replaceable LED austauschbare LED LED remplaçables |
| | loadable in kg belastbar in kg chargeable en kg |

| | |
|--|---|
| | packaging / delivery unit Verpackungs- / Liefereinheit unité d'emballage / de livraison |
| | shortable kürzbar réductible |
| | Voltage Volt Voltage |
| | Watt |
| | USB connection USB-Anschluss Connexion USB |
| | Qi-Charger |

PROTECTION CLASS
SCHUTZKLASSE
CLASSE DE PROTECTION

The protection class indicates to what extent the lamp is protected against electric shock. All lamps in this catalogue are at least protected with the protection class 1 - a higher class is specified in the information box of the respective lamp.

Die Schutzklasse gibt an, inwiefern ein Produkt gegen einen elektrischen Schlag gesichert ist. Alle Leuchten in diesem Katalog sind mit mindestens Schutzklasse 1 gesichert, bei höheren Klassen wird das Symbol im Infokasten der Leuchte angegeben.

La classe de protection indique, dans quelle mesure la lampe est protégée contre les chocs électriques. Tous les lampes dans ce catalogue sont protégées au moins avec la classe 1 - une classe plus élevée est indiquée dans l'information de la lampe.

| | |
|--|---|
| | protection class 1: protective earthing Schutzklasse 1: Schutzerdung classe de protection 1: prise de terre |
|--|---|

| | |
|--|---|
| | protection class 2: protective insulation Schutzklasse 2: Schutzisolation classe de protection 2: double isolation ou renforcée |
|--|---|

| | |
|--|---|
| | protection class 3: protective low voltage Schutzklasse 3: Schutzkleinspannung classe de protection 3: très basse tension de sécurité |
|--|---|

PROTECTION RATING
SCHUTZGRAD
INDICE DE PROTECTION

The protection rating ensures the operational safety of luminaires. The first number specifies the extent of the protection against the ingress of foreign bodies; the second number identifies the humidity protection grade. All luminaires in this catalogue are at least protected with the rating IP20 - a higher rating is specified in the information box of the luminaire.

Der Schutzgrad gewährleistet die Betriebssicherheit von Leuchten. Die erste Ziffer des IP Grades beschreibt den Schutzzumfang gegen das Eindringen von Fremdkörpern, die zweite Ziffer informiert über den Grad des Feuchtigkeitsschutzes. Alle Leuchten in diesem Katalog sind mit mindestens Schutzgrad IP20 gesichert, bei höheren Graden wird das Symbol im Infokasten der Leuchte angegeben.

L'indice de protection assure la sécurité opérationnelle des luminaires. Le premier chiffre indique à quel point la protection est efficace contre l'insertion de corps étrangers; le second chiffre indique quant à lui le degré de protection par rapport à l'humidité. Tous les luminaires dans ce catalogue sont protégés au moins avec l'indice IP20 - un indice plus élevé est indiqué dans l'information d'article.

| | |
|--|------|
| | IP33 |
| | IP44 |

| | |
|--|------|
| | IP54 |
|--|------|

| | |
|--|------|
| | IP65 |
|--|------|

| | |
|--|------|
| | IP67 |
|--|------|

REGISTER

ARTICLE NUMBER

ARTIKELNUMMER

NUMÉROS D'ARTICLE

| NUMBER NUMMER NUMÉRO | PAGE SEITE PAGE | NUMBER NUMMER NUMÉRO | PAGE SEITE PAGE | NUMBER NUMMER NUMÉRO | PAGE SEITE PAGE | NUMBER NUMMER NUMÉRO | PAGE SEITE PAGE | NUMBER NUMMER NUMÉRO | PAGE SEITE PAGE | NUMBER NUMMER NUMÉRO | PAGE SEITE PAGE | NUMBER NUMMER NUMÉRO | PAGE SEITE PAGE |
|----------------------------|-----------------------|----------------------------|-----------------------|----------------------------|-----------------------|----------------------------|-----------------------|----------------------------|-----------------------|----------------------------|-----------------------|----------------------------|-----------------------|
| 30761 | 266 | 95821 | 198 | 98129 | 148 | 98844 | 41 | 99155 | 246 | 99225 | 263 | 99643 | 211 |
| 30762 | 272 | 95822 | 198 | 98201 | 152 | 98845 | 42 | 99156 | 241 | 99226 | 264 | 99644 | 211 |
| 30891 | 266 | 95823 | 198 | 98203 | 152 | 98846 | 41 | 99157 | 242 | 99227 | 266 | 99669 | 21 |
| 30892 | 266 | 95843 | 202 | 98205 | 153 | 98847 | 42 | 99158 | 245 | 99228 | 263 | 99671 | 21 |
| 30893 | 272 | 95844 | 202 | 98206 | 153 | 98849 | 45 | 99159 | 246 | 99229 | 264 | 99684 | 54 |
| 30894 | 272 | 95846 | 202 | 98207 | 165 | 98852 | 45 | 99162 | 248 | 99232 | 266 | 99685 | 54 |
| 31683 | 232 | 95851 | 201 | 98208 | 165 | 98854 | 45 | 99163 | 248 | 99233 | 263 | 99686 | 55 |
| 31689 | 232 | 95852 | 201 | 98209 | 165 | 98865 | 255 | 99164 | 251 | 99234 | 264 | 99687 | 55 |
| 32811 | 149 | 95853 | 201 | 98212 | 242 | 98866 | 255 | 99167 | 248 | 99235 | 266 | 99716 | 292 |
| 32812 | 148 | 95855 | 201 | 98238 | 204 | 98867 | 255 | 99168 | 248 | 99236 | 268 | 99717 | 293 |
| 32813 | 149 | 95856 | 201 | 98241 | 204 | 98868 | 255 | 99169 | 251 | 99237 | 271 | 99718 | 293 |
| 32896 | 203 | 95857 | 201 | 98243 | 204 | 98869 | 255 | 99178 | 248 | 99238 | 272 | 99719 | 293 |
| 33107 | 156 | 95858 | 201 | 98244 | 204 | 98871 | 255 | 99179 | 248 | 99239 | 268 | 99721 | 295 |
| 33108 | 156 | 95859 | 201 | 98292 | 260 | 98901 | 172 | 99181 | 251 | 99241 | 271 | 99722 | 295 |
| 33391 | 207 | 96081 | 97 | 98293 | 260 | 98902 | 172 | 99183 | 248 | 99242 | 272 | 99723 | 295 |
| 33394 | 209 | 96151 | 161 | 98297 | 152 | 98903 | 172 | 99184 | 248 | 99243 | 268 | 99724 | 296 |
| 33996 | 204 | 96152 | 160 | 98301 | 207 | 98904 | 173 | 99185 | 251 | 99244 | 271 | 99726 | 279 |
| 33997 | 207 | 96153 | 160 | 98302 | 209 | 98905 | 173 | 99187 | 248 | 99245 | 272 | 99727 | 279 |
| 61355 | 162 | 96154 | 160 | 98303 | 207 | 99038 | 183 | 99188 | 248 | 99246 | 268 | 99728 | 146 |
| 61358 | 162 | 96791 | 286 | 98304 | 209 | 99039 | 183 | 99189 | 251 | 99247 | 271 | 99729 | 146 |
| 61359 | 163 | 96792 | 286 | 98305 | 207 | 99099 | 15 | 99191 | 242 | 99248 | 272 | 99833 | 168 |
| 61361 | 163 | 96794 | 286 | 98306 | 209 | 99106 | 15 | 99192 | 245 | 99252 | 268 | 99834 | 169 |
| 61489 | 162 | 96901 | 210 | 98307 | 207 | 99131 | 241 | 99193 | 246 | 99253 | 271 | 99835 | 169 |
| 93706 | 97 | 97079 | 218 | 98308 | 209 | 99132 | 242 | 99202 | 241 | 99254 | 272 | 99836 | 169 |
| 93707 | 97 | 97262 | 274 | 98418 | 154 | 99133 | 245 | 99203 | 245 | 99255 | 268 | 99841 | 185 |
| 94235 | 226 | 97263 | 274 | 98419 | 154 | 99134 | 246 | 99204 | 241 | 99256 | 271 | 99842 | 185 |
| 94236 | 226 | 97264 | 274 | 98472 | 209 | 99135 | 241 | 99205 | 245 | 99257 | 272 | 110337 | 89 |
| 94237 | 226 | 97265 | 274 | 98474 | 209 | 99136 | 241 | 99206 | 241 | 99258 | 264 | 110338 | 89 |
| 94239 | 228 | 97266 | 274 | 98571 | 292 | 99137 | 242 | 99207 | 245 | 99259 | 266 | 110339 | 86 |
| 94242 | 228 | 97267 | 274 | 98572 | 292 | 99138 | 245 | 99208 | 241 | 99263 | 264 | 110341 | 86 |
| 94406 | 231 | 97268 | 274 | 98573 | 294 | 99139 | 246 | 99209 | 245 | 99264 | 266 | 110342 | 86 |
| 94407 | 231 | 97269 | 274 | 98574 | 294 | 99141 | 241 | 99211 | 241 | 99265 | 266 | 110343 | 90 |
| 94408 | 231 | 97271 | 274 | 98607 | 204 | 99142 | 241 | 99212 | 245 | 99266 | 266 | 110344 | 90 |
| 94496 | 284 | 97279 | 274 | 98609 | 207 | 99143 | 242 | 99213 | 241 | 99267 | 266 | 110345 | 91 |
| 94497 | 284 | 97501 | 164 | 98611 | 209 | 99144 | 245 | 99214 | 245 | 99268 | 272 | 110346 | 91 |
| 94499 | 284 | 97502 | 164 | 98633 | 252 | 99145 | 246 | 99215 | 263 | 99269 | 272 | 110347 | 87 |
| 94501 | 282 | 97503 | 164 | 98634 | 252 | 99146 | 241 | 99216 | 264 | 99271 | 272 | 110348 | 87 |
| 94502 | 282 | 97571 | 95 | 98635 | 252 | 99147 | 241 | 99217 | 266 | 99337 | 278 | 110349 | 90 |
| 94503 | 283 | 97572 | 94 | 98637 | 222 | 99148 | 242 | 99218 | 263 | 99338 | 278 | 900044 | 34 |
| 94504 | 282 | 97573 | 94 | 98639 | 222 | 99149 | 245 | 99219 | 264 | 99493 | 204 | 900045 | 34 |
| 95359 | 233 | 97574 | 94 | 98766 | 155 | 99151 | 246 | 99221 | 266 | 99494 | 204 | 900046 | 34 |
| 95817 | 198 | 97927 | 296 | 98767 | 155 | 99152 | 241 | 99222 | 263 | 99548 | 30 | 900047 | 35 |
| 95818 | 198 | 97928 | 296 | 98842 | 41 | 99153 | 242 | 99223 | 264 | 99549 | 30 | 900048 | 35 |
| 95819 | 198 | 98025 | 149 | 98843 | 42 | 99154 | 245 | 99224 | 266 | 99639 | 30 | 900049 | 36 |

| NUMBER NUMMER NUMÉRO | PAGE SEITE PAGE | NUMBER NUMMER NUMÉRO | PAGE SEITE PAGE | NUMBER NUMMER NUMÉRO | PAGE SEITE PAGE | NUMBER NUMMER NUMÉRO | PAGE SEITE PAGE | NUMBER NUMMER NUMÉRO | PAGE SEITE PAGE | NUMBER NUMMER NUMÉRO | PAGE SEITE PAGE | NUMBER NUMMER NUMÉRO | PAGE SEITE PAGE |
|----------------------------|-----------------------|----------------------------|-----------------------|----------------------------|-----------------------|----------------------------|-----------------------|----------------------------|-----------------------|----------------------------|-----------------------|----------------------------|-----------------------|
| 900051 | 36 | 900486 | 24 | 900745 | 207 | 900967 | 215 | 901467 | 47 | 901571 | 75 | 901756 | 224 |
| 900052 | 36 | 900487 | 24 | 900746 | 207 | 900968 | 215 | 901468 | 48 | 901572 | 81 | 901757 | 224 |
| 900053 | 37 | 900558 | 180 | 900747 | 207 | 900969 | 215 | 901469 | 48 | 901573 | 81 | 901758 | 225 |
| 900054 | 26 | 900559 | 180 | 900748 | 201 | 901011 | 264 | 901471 | 50 | 901574 | 82 | 901759 | 225 |
| 900055 | 26 | 900561 | 180 | 900749 | 201 | 901012 | 266 | 901472 | 50 | 901575 | 83 | 901761 | 225 |
| 900056 | 26 | 900568 | 170 | 900751 | 228 | 901013 | 264 | 901473 | 50 | 901576 | 80 | | |
| 900057 | 32 | 900569 | 170 | 900752 | 229 | 901014 | 266 | 901474 | 51 | 901577 | 81 | | |
| 900058 | 32 | 900571 | 178 | 900753 | 227 | 901043 | 280 | 901475 | 51 | 901578 | 82 | | |
| 900059 | 32 | 900572 | 178 | 900754 | 227 | 901044 | 280 | 901476 | 49 | 901579 | 83 | | |
| 900061 | 33 | 900573 | 178 | 900758 | 28 | 901108 | 52 | 901477 | 49 | 901638 | 105 | | |
| 900062 | 33 | 900574 | 290 | 900759 | 28 | 901109 | 52 | 901524 | 78 | 901639 | 105 | | |
| 900095 | 37 | 900575 | 290 | 900761 | 29 | 901117 | 196 | 901525 | 78 | 901641 | 109 | | |
| 900099 | 38 | 900576 | 290 | 900762 | 29 | 901118 | 196 | 901526 | 79 | 901642 | 109 | | |
| 900101 | 38 | 900577 | 291 | 900763 | 17 | 901167 | 192 | 901527 | 78 | 901644 | 108 | | |
| 900102 | 41 | 900578 | 291 | 900764 | 16 | 901168 | 18 | 901528 | 79 | 901647 | 106 | | |
| 900103 | 42 | 900579 | 291 | 900765 | 17 | 901169 | 18 | 901529 | 79 | 901648 | 106 | | |
| 900104 | 45 | 900581 | 263 | 900766 | 16 | 901191 | 182 | 901537 | 70 | 901651 | 106 | | |
| 900105 | 38 | 900582 | 263 | 900815 | 234 | 901192 | 183 | 901541 | 60 | 901652 | 104 | | |
| 900106 | 38 | 900583 | 263 | 900816 | 235 | 901438 | 136 | 901542 | 60 | 901653 | 104 | | |
| 900107 | 41 | 900584 | 264 | 900817 | 150 | 901439 | 136 | 901543 | 60 | 901654 | 111 | | |
| 900108 | 42 | 900585 | 266 | 900818 | 150 | 901441 | 136 | 901544 | 61 | 901655 | 111 | | |
| 900109 | 45 | 900586 | 268 | 900819 | 151 | 901442 | 137 | 901545 | 62 | 901656 | 115 | | |
| 900111 | 38 | 900587 | 271 | 900821 | 151 | 901443 | 137 | 901546 | 62 | 901657 | 115 | | |
| 900112 | 38 | 900588 | 272 | 900822 | 151 | 901444 | 138 | 901547 | 62 | 901659 | 114 | | |
| 900113 | 41 | 900589 | 268 | 900912 | 194 | 901445 | 138 | 901548 | 63 | 901663 | 112 | | |
| 900114 | 42 | 900591 | 271 | 900913 | 195 | 901446 | 140 | 901549 | 63 | 901664 | 112 | | |
| 900115 | 45 | 900592 | 272 | 900914 | 194 | 901447 | 140 | 901551 | 65 | 901666 | 112 | | |
| 900116 | 15 | 900593 | 268 | 900915 | 195 | 901448 | 140 | 901552 | 65 | 901667 | 110 | | |
| 900181 | 264 | 900594 | 271 | 900931 | 255 | 901449 | 141 | 901553 | 65 | 901668 | 110 | | |
| 900182 | 266 | 900595 | 272 | 900932 | 255 | 901451 | 141 | 901554 | 66 | 901669 | 120 | | |
| 900183 | 271 | 900637 | 263 | 900933 | 255 | 901452 | 139 | 901555 | 66 | 901683 | 122 | | |
| 900184 | 272 | 900638 | 263 | 900934 | 255 | 901453 | 139 | 901556 | 67 | 901684 | 122 | | |
| 900251 | 210 | 900639 | 263 | 900935 | 255 | 901454 | 142 | 901557 | 67 | 901685 | 122 | | |
| 900451 | 235 | 900641 | 264 | 900936 | 255 | 901455 | 142 | 901558 | 68 | 901686 | 123 | | |
| 900452 | 236 | 900643 | 268 | 900937 | 158 | 901456 | 143 | 901559 | 68 | 901687 | 123 | | |
| 900453 | 236 | 900644 | 271 | 900938 | 158 | 901457 | 143 | 901561 | 68 | 901691 | 124 | | |
| 900454 | 235 | 900646 | 268 | 900939 | 158 | 901458 | 144 | 901562 | 69 | 901706 | 126 | | |
| 900455 | 237 | 900647 | 271 | 900959 | 174 | 901459 | 144 | 901563 | 69 | 901707 | 126 | | |
| 900456 | 237 | 900649 | 268 | 900961 | 174 | 901461 | 145 | 901564 | 70 | 901708 | 126 | | |
| 900481 | 22 | 900651 | 271 | 900962 | 212 | 901462 | 145 | 901565 | 70 | 901709 | 127 | | |
| 900482 | 22 | 900653 | 264 | 900963 | 213 | 901463 | 46 | 901566 | 74 | 901711 | 127 | | |
| 900483 | 22 | 900654 | 264 | 900964 | 213 | 901464 | 46 | 901567 | 74 | 901753 | 120 | | |
| 900484 | 23 | 900743 | 198 | 900965 | 213 | 901465 | 46 | 901568 | 74 | 901754 | 124 | | |
| 900485 | 23 | 900744 | 198 | 900966 | 214 | 901466 | 47 | 901569 | 75 | 901755 | 224 | | |

REGISTER

SERIES NAMES
SERIENNAMEN
NOME DE PRODUITS

| NAME NAME NOM | PAGE SEITE PAGE | NAME NAME NOM | PAGE SEITE PAGE | NAME NAME NOM | PAGE SEITE PAGE |
|---------------------|-----------------------|---------------------|-----------------------|---------------------|-----------------------|
| ALBARCA | 174 | FLEXIBLE STRIPE | 292-296 | SALOBRENA-M | 154 |
| AMMONIAK | 70 | FUEVA 1 | 252, 274 | SALOBRENA-RGBW | 156 |
| APPRODO | 78-79 | FUEVA 5 | 241-251, 263-272 | SALOBRENA-Z | 34-37 |
| AREITIO | 222 | FUEVA FLEX | 255 | SARSINA | 164 |
| ARENALS | 192 | FUEVA-A | 242, 260 | SARSINA-A | 165 |
| BALAZOTE | 182-183 | FUEVA-Z | 38-45 | SARSINA-Z | 28-29 |
| BASIC | 60-61 | HERRORA-Z | 30 | SARTIANO | 203 |
| BASIC PLUS | 62-63 | KOB LED | 97 | SAVATARILA | 183 |
| BOHOYO | 280 | LAZARAS | 185 | SICCIAROTTA | 75 |
| BORDONARA | 178 | LED STRIPE-Z | 54-55 | SLIM | 65 |
| CALONGE | 194-195 | LED STRIPES-FLEX | 296 | SLIM CCT | 66 |
| CALONGE RGB | 196 | LM_LED_G13 | 86-91 | SLIM SENSOR | 67 |
| CAROSSO | 234-237 | MARGIDORE | 79 | SUSPENSION | 70 |
| CAROSSO-Z | 16-18 | MARMORATA | 180 | TEDO | 232 |
| CHANGO | 218 | MATTANZA | 74 | TEDO 1 | 233 |
| COB STRIPE | 290-291 | MECINOS | 211 | TEYA | 97 |
| CONNECT Z | 15 | MINERARIO | 80-83 | TPLUS 6 LENS SPOT | 123, 127 |
| CONNECT-Z SENSOR | 15 | NEON-STRIFE-Z | 52 | TPLUS EXTENSION | 120, 124 |
| CONNECT-Z SWITCH | 15 | PADROGIANO-Z | 22-24 | TPLUS FLAT LIGHT | 122, 126 |
| CRESPILLO | 278-279 | PENETO | 226-231 | TPLUS PENDANT | 123, 127 |
| DUNDRY | 94-95 | PINEDA | 198-202 | TPLUS SLIM SPOT | 122, 126 |
| EASY FIX | 68 | POLASSO | 282-284 | TPLUS STARTER SET | 120, 124 |
| EASYT CONNECTOR | 109, 115 | PRIME | 69 | TPLUS WIDE SPOT | 122, 126 |
| EASYT CORNER | 109, 115 | RABASSA | 158 | TRUPIANA | 170 |
| EASYT E27 ADAPTER | 108, 114 | RAPITA | 212-215 | TURCONA | 172-173 |
| EASYT FEEDER | 105, 111 | ROVITO | 136-141 | TURCONA-CCT | 168-169 |
| EASYT PENDANT | 106, 112 | ROVITO-R | 142-145 | TURCONA-Z | 26, 32-33 |
| EASYT SET 3 SPOTS | 104, 110 | ROVITO-Z | 46-51 | URTEBIETA | 146 |
| EASYT SET 4 SPOTS | 104, 110 | SALABATE | 204 | ZARATE | 210 |
| EASYT SPOT RING | 106, 112 | SALICETO | 204, 207, 209 | | |
| EASYT SPOT TUBE | 106, 112 | SALICETO-Z | 21 | | |
| EASYT TRACK | 105, 111 | SALOBRENA 1 | 148-151, 160-163 | | |
| FAVAZZINA | 224-225 | SALOBRENA-A | 152-153 | | |
| FERREROS | 286 | SALOBRENA-B | 155 | | |



NOTES

NOTIZEN
NOTES



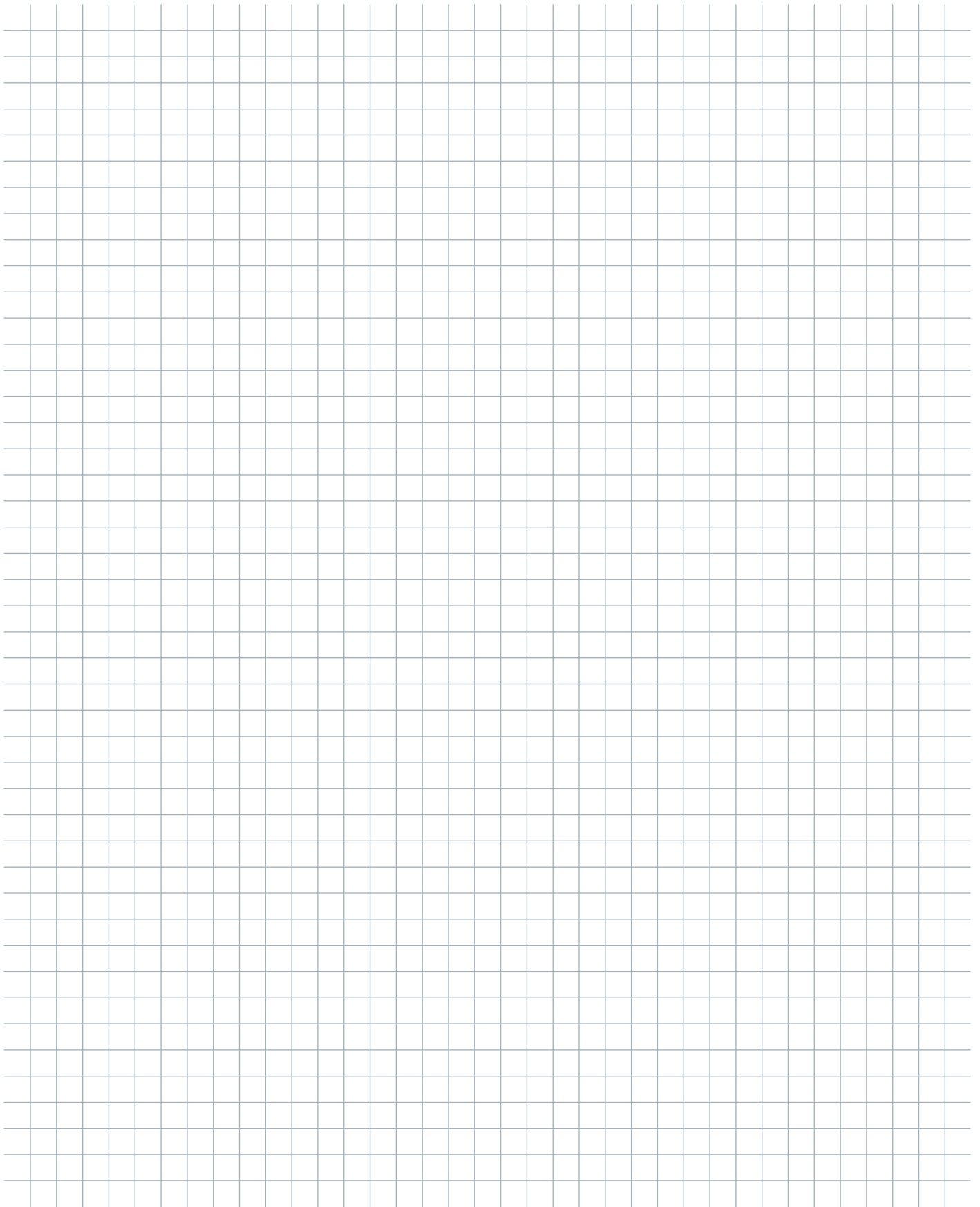

NOTES

NOTIZEN
NOTES



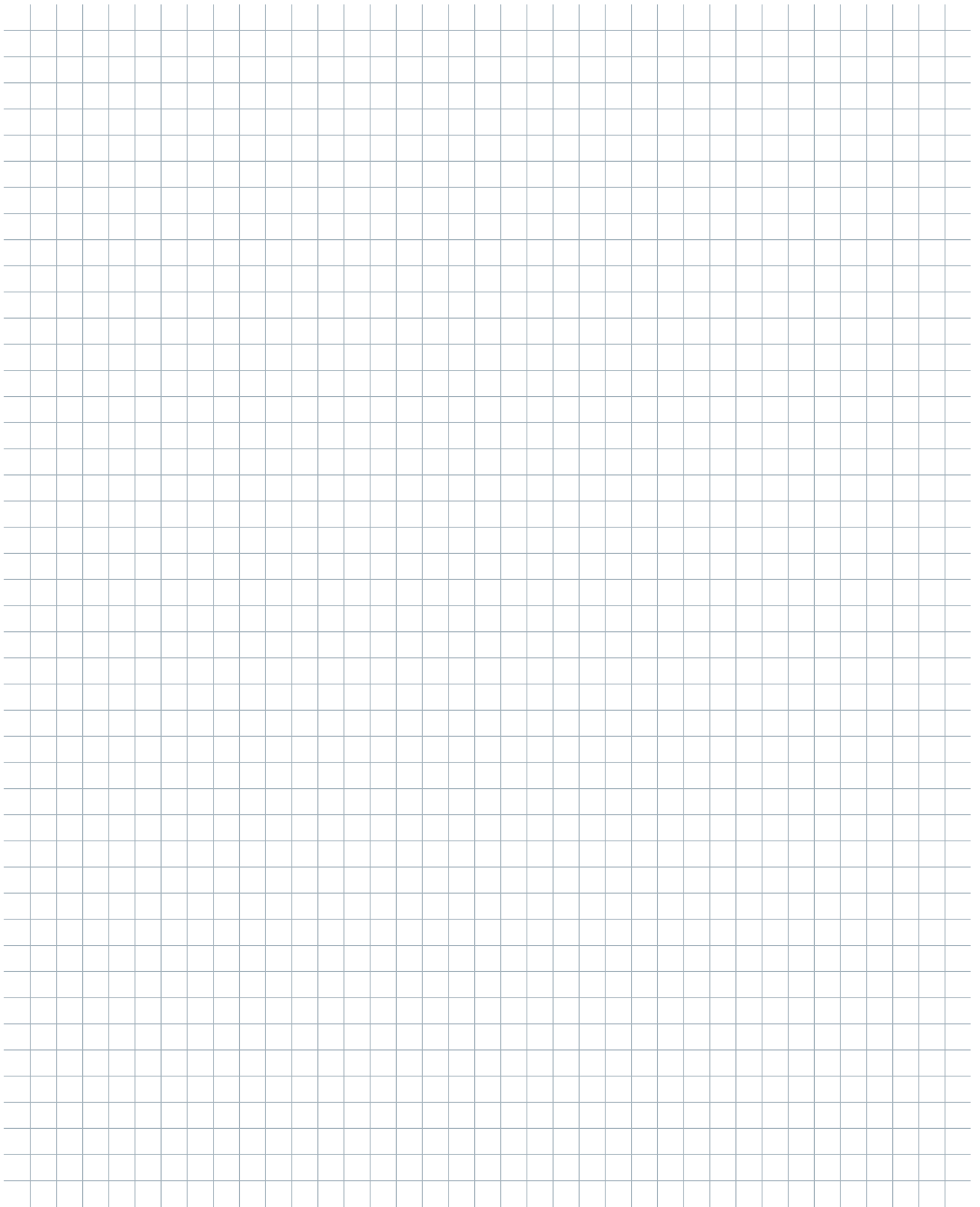



All previous catalogues and price lists are no longer valid with the issue of this catalogue. Errors, misprints, model and price changes and technical modifications are reserved. We deliver based on our terms of delivery and payment. Our products comply with the European light norm EN60598. Products with the ENEC test mark are conforming to the guide line 2006/95/EG. Products with additional safety remarks (e.g protection class, IP) are identified within the product family with the relevant symbol and number. The content of this catalogue is protected under copyright law for EGLO Leuchten GmbH. All rights reserved. Our specific written consent must be obtained before using any illustrations and texts. The pictures are 4C prints and may differ from the original. The product pictures and ambiences in this catalogue can deviate from reality, and they do not necessarily concur with the usual application of the product. EGLO does not assume liability for the correctness, completeness or the application depiction of the products and/or the product information.

Design, layout and composition:

EGLO GmbH, 6136 Pill - AUSTRIA

Print: Samson Druck GmbH, 5581 St. Margarethen - AUSTRIA

Pictures: EGLO, Adobe Stock, istockphoto.com, shutterstock.com

Mit diesem Katalog verlieren alle vorhergehenden Kataloge und Preislisten ihre Gültigkeit. Irrtümer, Druckfehler, Modell- und Preisänderungen sowie technische Änderungen vorbehalten. Wir liefern zu unseren Liefer- und Zahlungsbedingungen. Unsere Produkte entsprechen der europäischen Leuchtnorm EN 60598. Produkte mit dem ENEC Prüfzeichen sind konform mit der Richtlinie 2006/95/EG. Produkte mit weiteren Sicherheitshinweisen (zB. Schutzklasse, IP) sind mit Symbol und Zahl bei der Produktfamilie ausgezeichnet. Der Inhalt dieses Kataloges ist für die EGLO Leuchten GmbH urheberrechtlich geschützt. Alle Rechte sind vorbehalten. Bilder und Texte dürfen nicht ohne vorherige ausdrückliche, schriftliche Genehmigung verwendet werden. Die Abbildungen sind 4C Drucke und können vom Original abweichen.

Die Katalogbilder und die gezeigten Darstellungen der Produkte können von der Wirklichkeit abweichen und nicht den üblichen Produktanwendungen entsprechen. EGLO übernimmt keine Haftung für die Richtigkeit, Vollständigkeit und Anwendungsdarstellung der Produkte und Produktinformationen.

Gestaltung, Layout und Satz:

EGLO GmbH, A-6136 Pill - AUSTRIA

Druck: Samson Druck GmbH, 5581 St. Margarethen - AUSTRIA

Bilder: EGLO, Adobe Stock, istockphoto.com, shutterstock.com

Le présent catalogue remplace tous les catalogues et tarifs précédents. Sous réserve d'erreurs, de fautes d'impression, de modification des modèles et de changement de prix et de technique. Nous livrons sur la base de nos conditions de livraison et de paiement. Nos produits sont conformes aux normes européennes EN 60598 et portent le marquage CE. Les produits portant la marque ENEC sont conformes à la Directive 2006/95/EG. Les produits portant d'autres indications de sécurité (par exemple classe de protection, IP) sont identifiés par le symbole et le nombre correspondants dans la famille de produits.

Le contenu du présent catalogue est protégé pour la société EGLO Leuchten GmbH par un copyright. Tous droits réservés. Toute reproduction d'images et du texte est interdite sans autorisation explicite par écrit préalable. Les images sont imprimées en 4C et peuvent différer de l'original.

Les images des produits et les ambiences dans le catalogue peuvent dévier de la réalité et ne sont pas nécessairement en ligne avec l'usage habituel du produit. EGLO n'engage pas sa responsabilité sur la justesse des images et sur les informations relatives à l'usage pouvant être fait des produits.

Conception, maquette et composition :

EGLO GmbH, A-6136 Pill - AUSTRIA

Presse: Samson Druck GmbH, 5581 St. Margarethen - AUSTRIA

Images: EGLO, Adobe Stock, istockphoto.com, shutterstock.com

04-2024

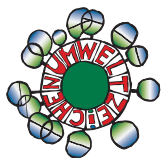

printed according to the Austrian Ecolabel criteria for printed matter, UW-Nr. 837

gedruckt nach der Richtlinie "Druckerzeugnisse" des Österreichischen Umweltzeichens, UW-Nr. 837

imprimé selon la directive „Produits imprimés du label écologique autrichien, UW-Nr. 837





EGLO Leuchten GmbH
Heiligkreuz 22
A-6136 Pill
Austria
Tel. +43 (0) 5242 6996
Fax +43 (0) 5242 6996-972
info@eglo.com
www.eglo.com

KATTLIS24



my light | my style