



THE PORTFOLIO AT A GLANCE

# LEDVANCE LED STRIP SYSTEM

SEPTEMBER 2020



[LEDVANCE.COM](http://LEDVANCE.COM)



**LEDVANCE**

# LEDVANCE: ADVANCING LIGHT

## BAD LIGHT MAKES YOU FREEZE? WE'VE GOT A SOLUTION FOR THAT!

As a trusted partner for general lighting, all our actions are directed at the fight against bad light. At LEDVANCE we combine traditional and modern, future-oriented lighting technologies. We build on long-term customer relationships and a strong sales network. We are experts in general lighting throughout the world, in technology trends and in the rapidly changing requirements for good light.

As a strong local partner, we are represented in over 140 countries. Our team of specialists focuses on the specific demands of our customers – whether they need lamps or electronic components such as our versatile new LED Strip System. The extensive LEDVANCE portfolio covers virtually any professional and residential application – from basic to sophisticated lighting.





Featuring new, dynamic Tunable White, RGBW and RGB products as well as new drivers, our extended LED Strip portfolio in particular is characterized by a strong customer focus. Each product development is based on our core philosophy: to offer user-friendly, intelligent lighting solutions that aim to improve the well-being of people – boosting concentration and performance.

Because we always focus on the practical benefits, our LED Strip System is also easy to plan, easy to install and easy to combine.

Based on these principles, we will continue to develop sophisticated products and provide you with optimum support in your personal fight against bad light.

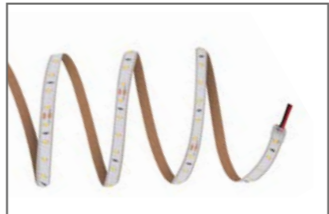
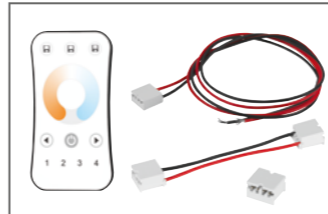
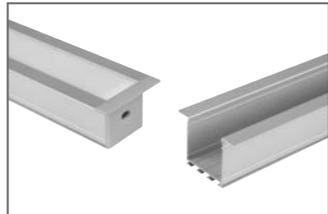

# CONTENTS

LEDVANCE: ADVANCING LIGHT	02
AS FLEXIBLE AS YOUR DEMANDS	04
SYSTEM COMPONENTS	06
SEGMENTATION OF THE PRODUCTS	07
APPLICATIONS FOR THE LED STRIPS	08
SUPERIOR CLASS - WHITE, TUNABLE WHITE	08
PERFORMANCE CLASS - WHITE, RGBW	10
VALUE CLASS- WHITE, RGB	12
SERVICE – CONFIGURATOR AND TRAINING CENTER	14
SERVICE – INSTALLATION INSTRUCTIONS	16
THE RANGE OF LED STRIPS	
 LED STRIPS SUPERIOR CLASS 18	
 LED STRIPS PERFORMANCE CLASS 32	
 LED STRIPS VALUE CLASS 48	
 ACCESSORIES 62	
 PROFILES 65	
 LED DRIVERS FOR CONSTANT VOLTAGE 71	
FEED LENGTHS	78
COMPATIBILITY OVERVIEW	80
LIGHTING CONTROL FROM OSRAM	82
SERVICE – ONLINE PORTAL	84
THE FULL LEDVANCE RANGE	85
NAMING IN THE LED STRIP SYSTEM	86
SYMBOLS AND ABBREVIATIONS	87

The pictures in the brochure are for illustration purposes only. All the technical parameters apply to the entire LED module. In view of the complex manufacturing process for light emitting diodes, the typical values given above for the technical LED parameters are merely statistical values that do not necessarily correspond to the actual technical parameters of an individual product; individual products may vary from the typical values.

# AS FLEXIBLE AS YOUR DEMANDS: THE NEW LEDVANCE LED STRIP SYSTEM

Quality and functionality are what counts – day in, day out. The new LEDVANCE LED Strip System offers you exactly what you need to meet your various demands – uncomplicated and professional. A portfolio of matching electronic components covering an extremely wide variety of applications. All perfectly coordinated, flexible, reliable and easy to handle. A guarantee of up to five years and excellent customer service available at any time round off the package.

### EASY TO PLAN

The LED Strip System Configurator leads you step by step to perfect results – it has never been easier to plan the quantities and types of components needed for your specific lighting job. And this also makes designing easier for you. The LEDVANCE LED Strip System is compatible with many components from other established providers. Simply plan your project at: [ledvance.com/led-strip-configurator](http://ledvance.com/led-strip-configurator)

### EASY TO LEARN

LEDVANCE's online training center offers a variety of application-oriented eLearning activities, including practical information on planning, product selection, installation and more. Take a look at: [training.ledvance.com](http://training.ledvance.com)

### EASY TO COMBINE

Everything from a single source, everything perfectly coordinated. The LEDVANCE LED Strip System comprises LED Strips, drivers, profiles and accessories. New DALI-2 drivers also extend the range of combinations and applications. The modular design saves you valuable time on installation.

### EASY TO INSTALL

Prewired on both sides, with optimized strip lengths, easy and flexible shortening. The LEDVANCE LED Strip System meets your needs. Your work is done in no time.

### EASY SELECTION

With white light colors from comfortably warm 2,700 kelvin to activating 6,500 kelvin as well as the dynamic new Tunable White, RGBW and RGB solutions, you have all the options for a wide variety of applications. Tunable White easily switches between activating work light and atmospheric warm light for relaxing. The color-changing LED Strip versions provide modern accents in any ambience. This is how you can impress your customers.

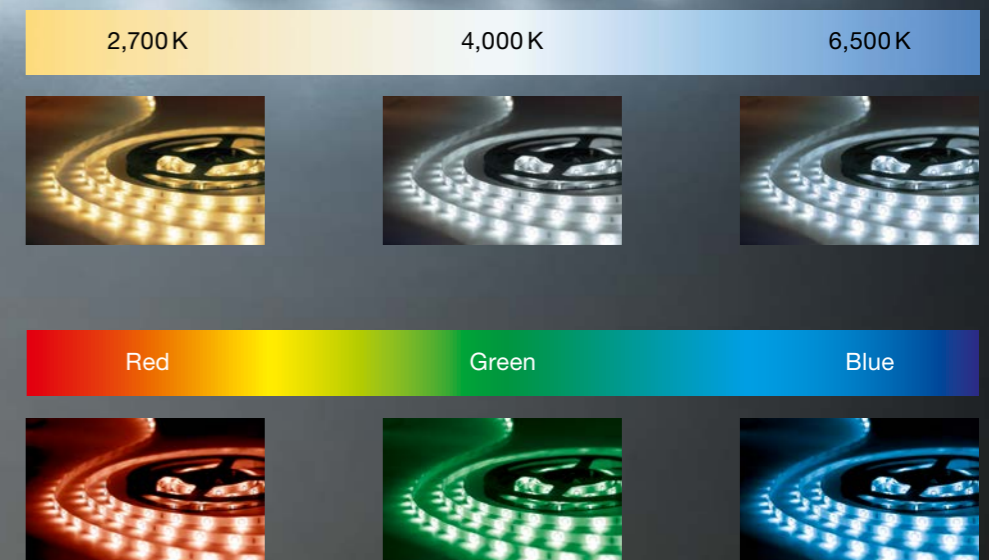

# TAILOR-MADE PRODUCTS SYSTEM COMPONENTS

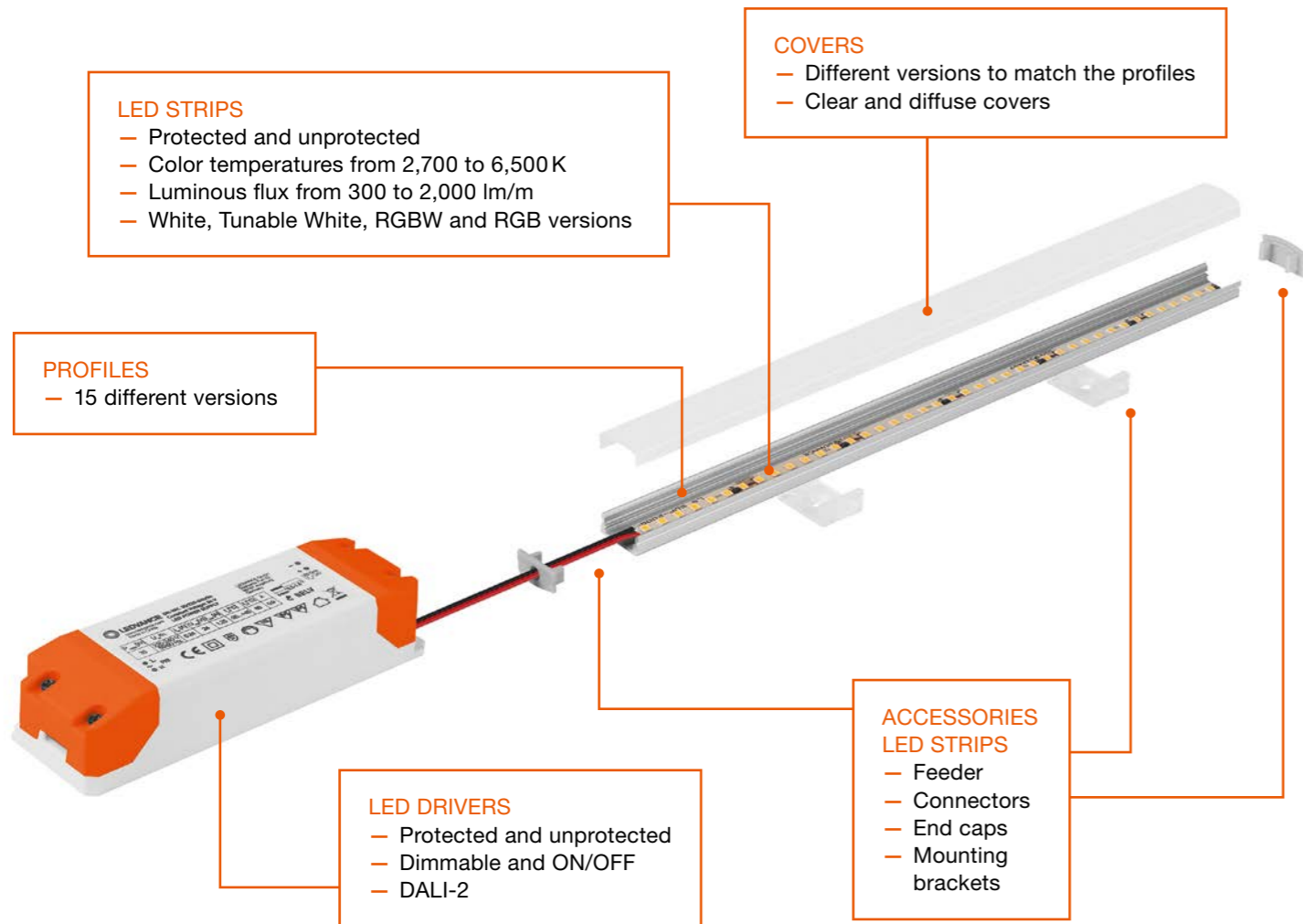

## THE GREAT FEELING OF COPING WITH MAJOR CHALLENGES

The LEDVANCE LED Strip System contains all the components you need for your modern lighting tasks. LED Strips, profiles, covers and drivers in many different versions as well as high-quality accessories. The benefit for you is that you don't have to spend time searching for specific components and making sure that they all match. Everything comes from a single source, matches perfectly and is easy to install.

High IP rating? No problem. Dimmable light? Possible at any time with the appropriate driver or lighting management system. And for complex dynamic lighting projects you can simply add the appropriate sensors. It has never been easier to impress your customers with optimum lighting solutions.

All the LED Strips from LEDVANCE are equipped with high-quality LEDs in the highest energy efficiency classes (A, A+ and A++). Energy efficiency class (EEI) on a scale from A++ (highest efficiency) to E (lowest efficiency).

# FULL BANDWIDTH TO THE POWER OF THREE: SEGMENTATION OF PRODUCTS

Your work involves everything from simple lighting tasks to the most complex and demanding – and it is precisely this bandwidth that is covered by LEDVANCE's electronic components. Clear segmentation into Superior, Performance and Value classes helps you to find the right products quickly and reliably. So you can easily meet the needs of your customers – today and tomorrow.

Clear color coding on the packaging will help you keep track of the products and quickly identify the right product for the job.



Our LEDVANCE Superior Class contains the highest quality products we have to offer. If you have special requirements or want to impress potential customers with a showcase project, you will find what you are looking for here.

General applications: major and prestige projects for indoor, outdoor and wet areas, as well as applications exposed to salt mist and high levels of UV.



The LEDVANCE Performance Class is our core portfolio for high-quality demand-based products. This range contains our widest selection of products. You can be sure to find a reliable solution for the majority of your lighting needs.

General applications: minor projects for indoor, outdoor and wet areas, as well as applications exposed to salt mist and high levels of UV.

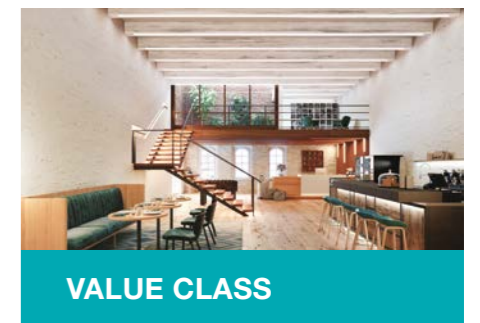

The LEDVANCE Value Class offers a good combination of strong performance and attractive prices. This particular portfolio focuses on the added value of our customers. Here you can find reliable products at economically beneficial prices.

General applications: small, semi-professional lighting projects for indoor, outdoor and wet areas.

# SUPERIOR CLASS BRILLIANT APPEARANCE

When every detail counts, the light also has to be superior in every respect. LEDVANCE LED Strips Superior Class are impressive for their quality of light, energy efficiency and durability. They are therefore ideal for exclusive flagship projects and all other highly demanding lighting tasks.

For inspirational lighting solutions in ambient, cove and general applications there are various light colors from warm white to daylight white, as well as a wide range of luminous fluxes. Particularly high values for color rendering and color consistency make LEDVANCE LED Strips Superior Class the first choice specifically for prestigious construction projects, luxury retail outlets and industry. Even for major projects in which durability and efficiency are prime considerations you need look no further than these high-end products. Not only do they comply with demanding safety standards and have multiple seals of approval, they also last a very long time – up to 60,000 hours. LEDVANCE provides a five-year guarantee for its LED Strips Superior Class.<sup>1</sup>

**GENERAL LIGHTING**  
LEDVANCE LED Strips Superior Class are excellent for delivering powerful and effective general lighting – with a luminous flux of 1,000 to 2,000 lm/m.

**AMBIENT LIGHTING**  
LED Strips with 300 to 600 lm/m are ideal for atmospheric accent lighting. The protected version can also be used in wet areas.

**COVE LIGHTING**  
Luminous fluxes of 600 to 1,000 lm/m are available for fascinating indirect lighting of niches and coves.

For precise terms and conditions go to: [www.ledvance.com/guarantee](http://www.ledvance.com/guarantee)

# PERFORMANCE CLASS FOR EVERY OCCASION

Good light – as it should be. The LEDVANCE LED Strip Performance Class delivers precisely what your commercial customers expect of high-quality demand-led products. These lighting solutions are an excellent choice for open-plan offices, conference rooms, cafes and many, many other large and small applications in an extremely wide range of sectors.

The Performance Class is notable for its extremely broad portfolio. Four color temperatures from 2,700 K to 6,500 K and different luminous fluxes from 300 lm/m to 2,000 lm/m cover a wide variety of applications – from relaxing to energizing, from atmospheric to general. And the hard facts don't lie. In terms of energy efficiency and durability, protection rating and reliability, color rendering and color consistency, the Performance Class easily meets the requirements of virtually every sector. And with a three-year guarantee<sup>1</sup> these LED Strips are the perfect allrounders for your lighting business.

**GENERAL LIGHTING**  
As bright as daylight – with a luminous flux of 1,000 to 2,000 lm/m, great flexibility and high efficiency, LEDVANCE LED Strips Performance Class are ideal for general lighting in large offices – especially in the color temperature of 6,500 K



**COVE LIGHTING**  
Tailored to a very wide variety of areas – luminous fluxes of 600 to 1,000 lm/m are available for illuminating niches or coves. As always in the Performance Class, there are four color temperatures from 2,700 to 6,500 K.



**AMBIENT LIGHTING**  
Performance down to the finest detail – with the protected LEDVANCE LED Strips in luminous fluxes from 300 to 600 lm/m and four white light colors you can provide professional accent lighting indoors and outdoors.

<sup>1</sup> For precise terms and conditions go to [www.ledvance.com/guarantee](http://www.ledvance.com/guarantee)

# VALUE CLASS QUALITY AT AFFORDABLE PRICES

The lighting solutions in the LEDVANCE LED Strip Value Class are impressive twice over. Because they offer amazing performance at affordable prices.

The Value Class provides you with excellent arguments for impressing your price-conscious customers. Different light colors from warm white to daylight white cover a wide spectrum of applications. A wide bandwidth of luminous fluxes enables these strips to be used for ambient, cove and general lighting. A life of up to 20,000 hours coupled with low purchase costs make them extremely economical for residential and small commercial applications. The Value Class will undoubtedly become a permanent asset in your lighting business.

**GENERAL LIGHTING**  
At 1,000 to 1,400 lm/m LEDVANCE LED Strips Value Class provides powerful and efficient general lighting – from daylight white with 6,500 K to an especially pleasant warm white with 2,700 K.

**AMBIENT LIGHTING**  
Want eye-catching staircase lighting at a good price-performance ratio? Look no further than LED Strips Value Class with a luminous flux of between 300 and 600 lm/m and four different color temperatures.

**COVE LIGHTING**  
Perfect light anywhere in coves and niches thanks to LED Strips with 600 to 1,000 lm/m. Shown here as an under-cabinet luminaire with a high IP rating for damp areas.

# THE SYSTEMATIC APPROACH TO SUCCESS USE OUR ONLINE TOOLS

## STEP BY STEP TO A CUSTOMIZED SOLUTION

# LED STRIP SYSTEM CONFIGURATOR

The quick and intuitive LED Strip System Configurator\* makes it extremely easy to plan any lighting project. You can use this handy online tool to define lighting requirements, mounting type, accessories, operating mode and drivers step by step. At the end, you will receive a summary with all the necessary components and useful information about mounting and installation. Of course, you can save the results of your configuration for future use. **It's easy to get started.**

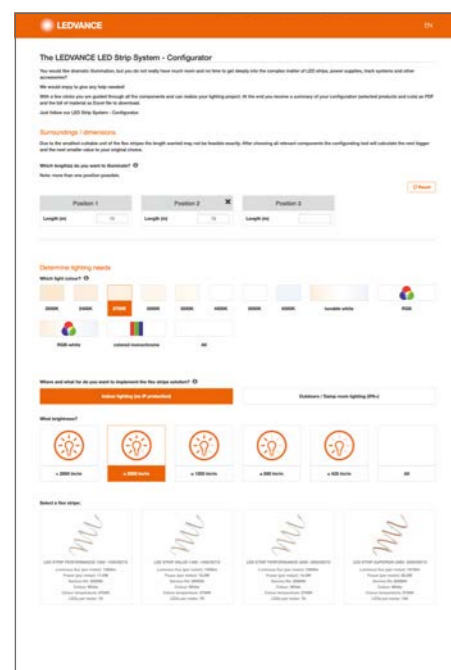
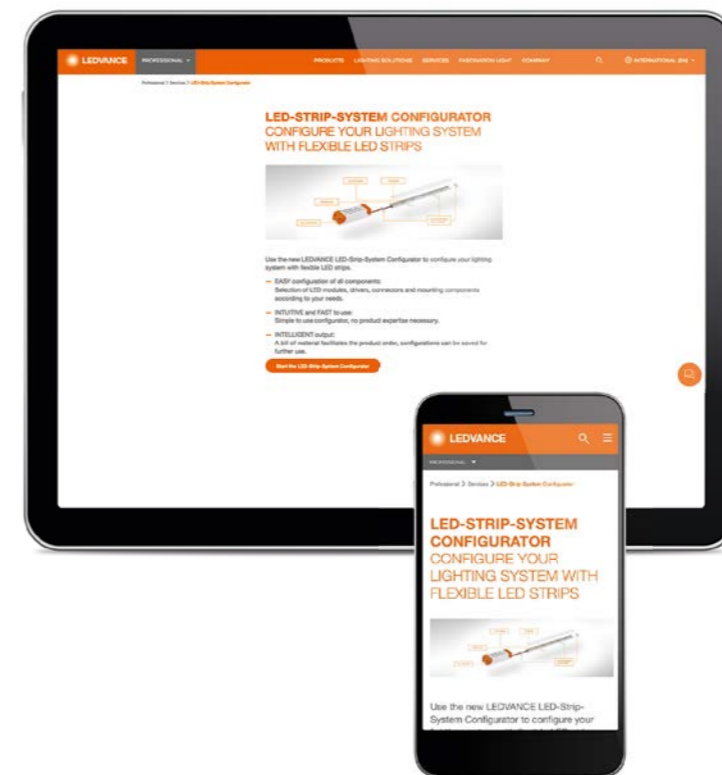

### Step 1 – Lighting requirements

In addition to the length of the LED Strips, here you can also specify the light color, the area of application and the required luminous intensity.

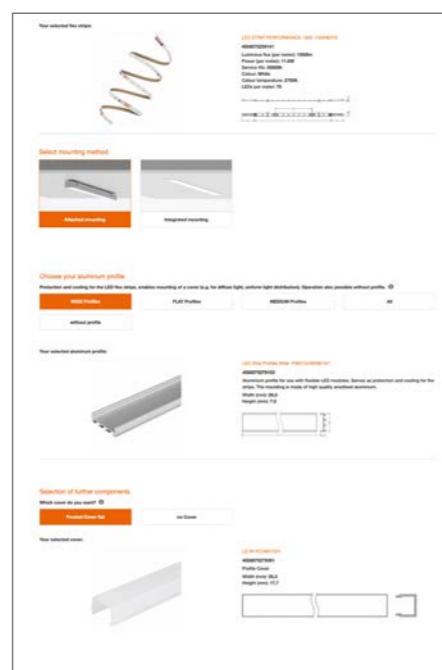

### Step 2 – Mounting type

Here you can decide whether you want surface or recessed mounting, and select the right aluminum profile and cover for your project.



### Step 3 – Accessories

Now you can specify all the other components: connectors, end caps and mounting accessories.

### Step 4 – Operating mode

Finally, you can determine a suitable operating mode, select the right drivers and complete configuration.

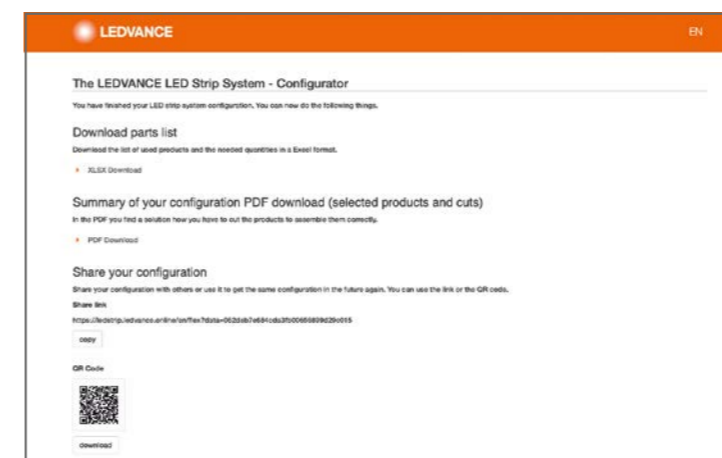

### Step 5 – Summary

After completing your configuration, in addition to a clear Excel parts list with all important product information you will receive a PDF with the selected products, the cuts and a wiring diagram. You can customize the Excel sheet if needed and then send it to your wholesaler for ordering.

Visit us at [www.ledvance.com/led-strip-configurator](http://www.ledvance.com/led-strip-configurator)

## LEDVANCE TRAINING CENTER: DEEPER KNOWLEDGE MADE EASY

Learn all you need to know about technology, products and applications. And discover the world of light in an interactive and interesting way.

Simply register at [www.training.ledvance.com](http://www.training.ledvance.com)

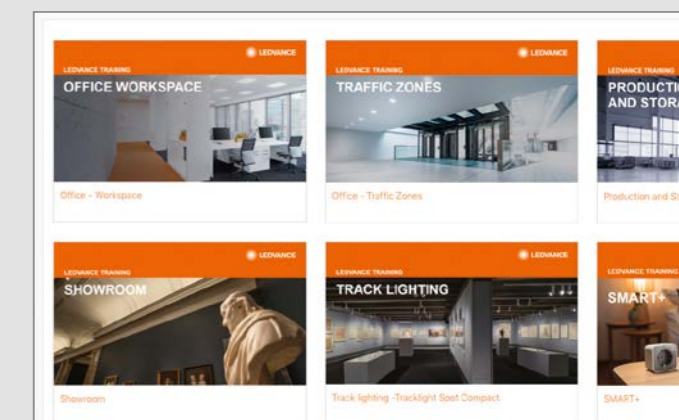

Current training courses are shown in a clear and self-explanatory layout. This allows you to dive right into the topic you want to learn about, refresh your knowledge and discover new things.

## TIPS AND TRICKS FOR DIFFERENT APPLICATIONS

- Office: How lighting in the workplace can contribute to the well-being of employees
- Traffic zones: How light provides orientation in corridors and avoids trip hazards in stairwells
- Industry: How to illuminate production and warehouse areas in an energy-efficient and standard-compliant manner
- Retail area: How to turn consumers' eyes and attract attention in retail areas
- Product highlights: What defines attractive track lighting today

\* The LED Strip System Configurator is no substitute for comprehensive professional planning with DIALux and RELUX or other professional light planning software



# TIPS FOR PROFESSIONALS FOR LED STRIP INSTALLATION

## THIS IS HOW THE LED STRIP SYSTEM WORKS

Tailor-made lighting solutions can be realized using LEDVANCE LED Strips. To ensure that you can professionally install the LED Strips for any project, here is some important information on the design, operation and handling of the strips – insider knowledge that will help you save time, nerves and budget and leave a professional impression on your customers.

### GENERAL INFORMATION

- LEDVANCE LED Strips are easy to handle, prewired on both sides and easy to wire without any tools
- They are dimmable, and the Tunable White, RGBW and RGB strips are also suitable for dynamic colored lighting
- Easy mounting on many smooth surfaces with self-adhesive tape
- It is important to select an LED driver and/or dimmer suitable for the application
- The basic rule is as follows: The total output of the LED Strip must not exceed the maximum output of the driver

PCB (PRINTED CIRCUIT BOARD)

CURRENT CONTROL

LED

CUTTING AREA

### IMPORTANT: NOTES ON HANDLING

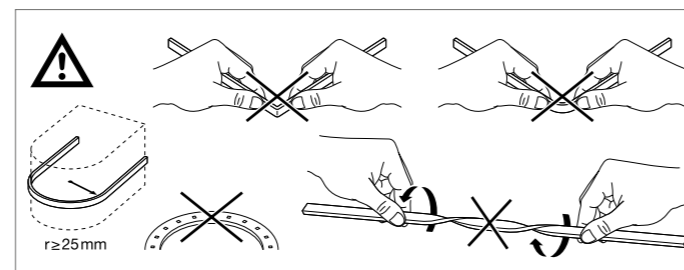

– Do not fold, bend or twist

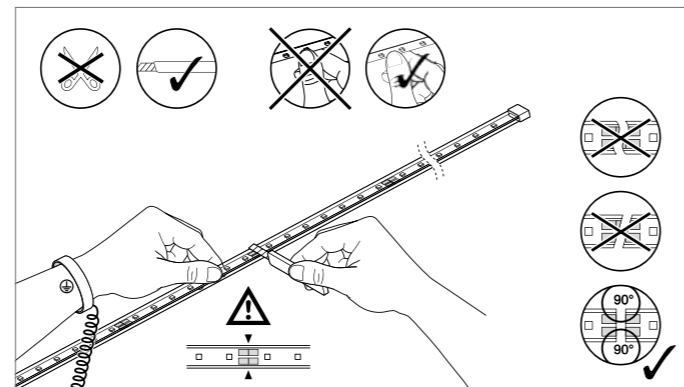

- Cut only in the designated areas
- Cut straight
- Note ESD protection
- Do not touch the LEDs on IP00 strips

## HOW TO WIRE LED STRIPS CORRECTLY

LEDVANCE LED Strips are easy to install. Which components you need to wire your project and how to connect them depends on whether you want to implement a static lighting solution in a white light color or a dynamic lighting solution with Tunable White, RGBW or RGB options.

## EXAMPLE WIRE DIAGRAMS: STATIC VS. DYNAMIC LED STRIP SYSTEM

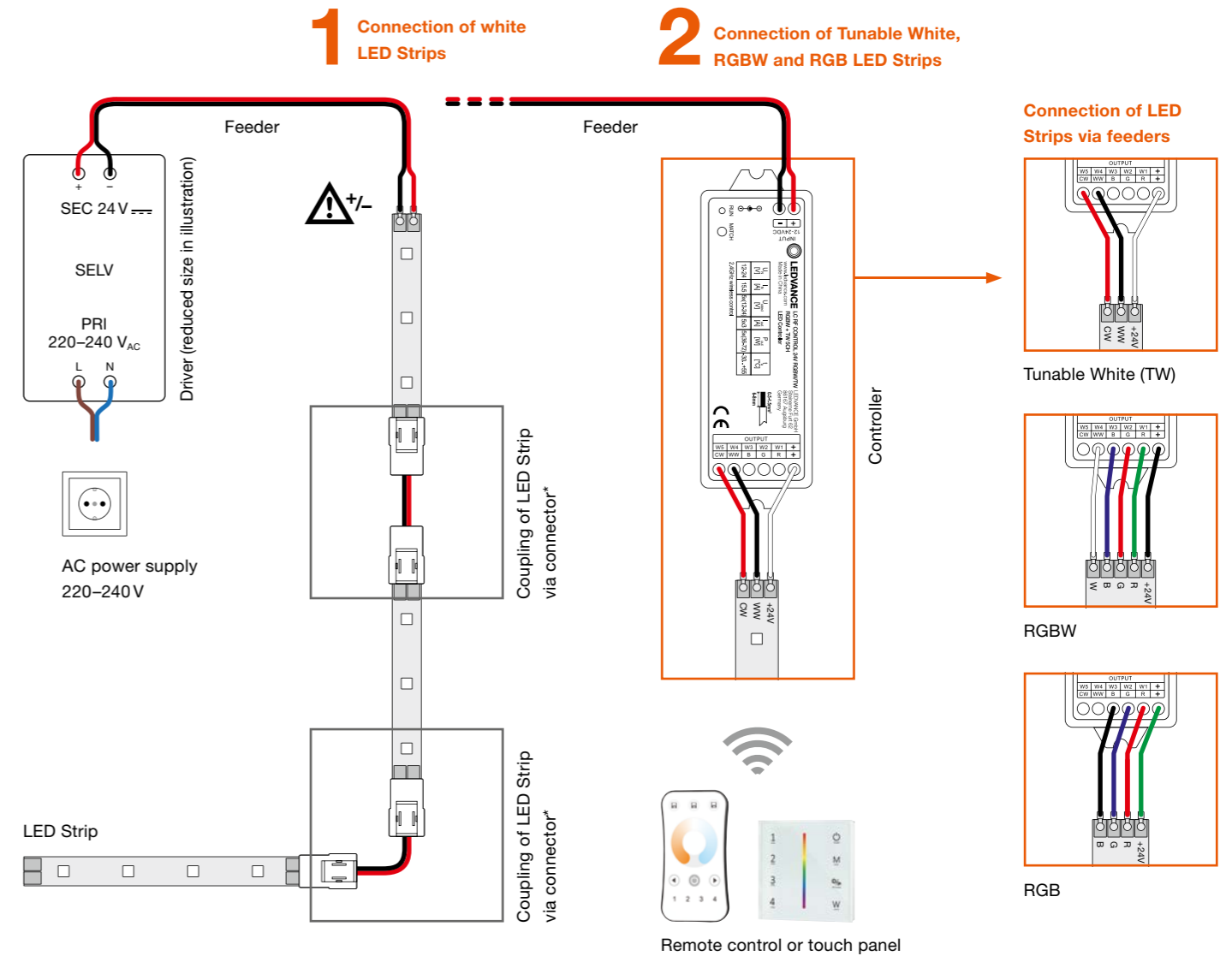

### 1. LED Strip System in a light color

If you are planning an LED Strip System with static white light, connect the driver to the power supply on one side and to the LED Strip on the other (+ and – respectively). To connect several LED Strips, use connectors\* or a parallel connection.

### 2. Dynamic LED Strip System (Tunable White, RGBW, RGB)

In addition to the LED Strips and a suitable driver, you need a multichannel controller as well as a touch panel or remote control. Tunable White works with three connections (CW, WW and +), RGBW with five connections (R, G, B, W and +) and RGB with four connections (R, G, B and +).

### AT A GLANCE

Are you looking for the right components for your LED Strip System? You'll see them at a glance in the compatibility overview on pages 78–79. Or simply visit the LED Strip Configurator at: [www.ledvance.com/led-strip-configurator](http://www.ledvance.com/led-strip-configurator)

\* Note the maximum feed length, see pages 76–77

# LED STRIPS AT THEIR BEST

## THE SUPERIOR CLASS RANGE AT A GLANCE

SUPERIOR CLASS

WHITE

There are jobs where the best is only ever just good enough. For your most demanding lighting jobs you should choose the LEDVANCE Superior Class. The products in this range offer high levels of durability and reliability. They also have impressive color rendering and homogeneity. Do you have special requirements for indoor or outdoor applications? The LEDVANCE Superior Class delivers.



- A life of up to 60,000 hours<sup>1</sup>
- Color rendering index CRI ≥ 90
- Color consistency SDCM ≤ 3
- Luminous fluxes from 500 to 2,000 lm/m – tailored for ambient, cove and general lighting
- 5 color temperatures: 2,700 K, 3,000 K, 4,000 K, 6,000 K, 6,500 K
- Type of protection IP 00/67
- Salt mist resistant (to IEC 60068-2-52) and UV resistant (to IEC 60068-2-5) at IP67
- ENEC and TÜV approval
- 5-year guarantee<sup>2</sup>

### AMBIENT LIGHTING

Do you need an exceptional eye-catcher? Thanks to their high IP67 rating, the LED Strips Superior Class can be used to create stunning lighting scenarios, as shown here with this protected version. At the sides of this water wall LEDVANCE LED Strips Superior Class with **3,000 K**, **500 lm/m** and **IP67** have been placed within a wide profile. The cover offers additional spray protection and enhances the lighting effect on the water.

### COVE LIGHTING

Brilliant good looks: Merchandise is displayed to best effect by indirect neutral white cove lighting equipped with LED Strips Superior Class. High-quality luxury goods and designer products will sell better in the premium lighting that they deserve. Along the back wall LEDVANCE LED Strips Superior Class with **4,000 K**, **800 lm/m** and **IP00** provide homogeneous illumination in a shallow profile with a diffuse cover.

### GENERAL LIGHTING

As bright as day: With their high luminous flux and daylight white 6,500 K color temperature, LED Strips Superior Class on ceilings and walls produce energizing and neutral general lighting for large spaces such as shopping malls and industrial buildings. LEDVANCE LED Strips Superior Class with **6,500 K**, **2,000 lm/m** and **IP00** can be used with appropriate drivers to create long-run strip lighting that provides optimum illumination. Their durability and low maintenance make them ideal for large high-ceiling spaces.

<sup>1</sup> L80/B10 at T<sub>a</sub>: 45 °C | <sup>2</sup> For precise terms and conditions go to [www.ledvance.com/guarantee](http://www.ledvance.com/guarantee)



### PRODUCT BENEFITS

- Great design freedom thanks to long, flexible LED Strips
- Easy installation and tool-free connection
- Easy mounting on many smooth surfaces with self-adhesive tape
- Protected LED Strips suitable for use in damp environments thanks to high degree of protection (IP67)
- Maximum flexibility thanks to a wide range of accessories
- Simple connection thanks to integrated cables on both sides

### APPLICATIONS

- General indoor lighting
- Protected LED Strips for general outdoor lighting (IP67)
- Industry
- Offices, sales and conference rooms
- Architectural lighting
- Decorative lighting

## LED STRIP SUPERIOR-500

LED strips with 500 lm/m for professional applications with very good color rendering and lifetime



Prewired cables on both sides

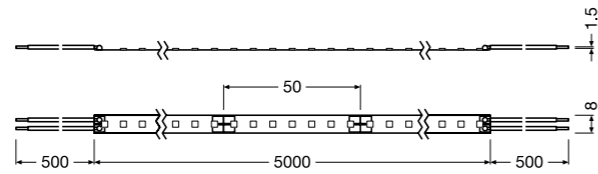

IP00  
 CRI > 90  
 SDCM ≤ 3  
 DIM  
 5 year guarantee  
 LEDVANCE

SHORT PITCH  
 TUV SUD  
 UL

E-number	Product name	GTIN (EAN)	COLOR	K	Im	Im	W	W	Im/W	V <sub>DC</sub>
LS SUP-500/927/5		4058075237049	Warm white	2700	485	2425	5.3	26.5	92.0	24
LS SUP-500/930/5		4058075237063	White	3000	520	2600	5.3	26.5	99.0	24
LS SUP-500/940/5		4058075237087	Cool white	4000	525	2650	5.3	26.5	99.0	24
LS SUP-500/965/5		4058075237100	Daylight	6500	575	2875	5.3	26.5	108.0	24

Product name	PITCH [mm]	α	IP	t <sub>m</sub>	T <sub>a</sub>	L x W x H [mm]	CABLE LENGTH	Imax [mA]	PRICE [EUR]	PRICE METER [EUR]
LS SUP-500/927/5	140	7.14	120	A+	60000	-20...+50	5000x8.0x1.5	500	50.0	
LS SUP-500/930/5	140	7.14	120	A+	60000	-20...+50	5000x8.0x1.5	500	50.0	
LS SUP-500/940/5	140	7.14	120	A+	60000	-20...+50	5000x8.0x1.5	500	50.0	
LS SUP-500/965/5	140	7.14	120	A+	60000	-20...+50	5000x8.0x1.5	500	50.0	

<sup>1</sup> Refer to www.ledvance.com/guarantee for precise conditions | <sup>2</sup> Dimmable with suitable drivers, see also www.ledvance.com/dim | <sup>3</sup> L80/B10 at T<sub>p</sub> 45°C | <sup>4</sup> Recommended retail price excl. VAT

### STRIP ACCESSORIES

Extract from the system components of the extensive LED Strip accessories

► Details see chapter STRIP ACCESSORIES

#### CONNECTORS



LS AY SUP-CP/P2/500  
4058075304413

#### ENDCAPS



LS AY SUP-CSD/P2  
4058075304444

#### MOUNTING BRACKETS



LS AY PFM-8/SMB  
4058075275645

### PROFILES

Matching profiles (orange) with corresponding covers and installation accessories

► Details see chapter PROFILES

LS AY SUP-PF01/U/ 16X10/13/1 4058075304741	LS AY SUP-PFS01/16X10/ 13/0,015 4058075304710	LS AY-PW01/U/ 26X8/14/1 4058075278103	LS AY-PW02/UW/ 39X26/14/1 4058075278134	LS AY-PW03/U/ 26X26/14/1 4058075278165	LS AY-PF01/UW/ 22X6/10/1 4058075278196	LS AY-PF02/U/ 16X5/10/1 4058075278226	LS AY-PF03/UW/ 25X7/12/1 4058075278257
LS AY-PF04/U/ 17X7/12/1 4058075278288	LS AY-PM01/UW/ 21,5X12/10/1 4058075278318	LS AY-PM04/UW/ 23X15,5/10/1 4058075278400	LS AY-PM05/U/ 17,5X14,5/10/1 4058075279278	LS AY-PM02/R/ 18X15,5/10/1 4058075278349	LS AY-PM03/E/ 19X19/10/1 4058075278370	LS AY-PM06/E/ 18X18/12/1 4058075279308	

### DRIVERS

Extract from the versatile driver portfolio

► Details see chapter DRIVERS



DR DALI-SUP-45/220-240/24  
4058075421820

DR DIM-PFM-40/220-240/24/P  
4058075379176

DR VAL-30/220-240/24  
4058075240056

## LED STRIP SUPERIOR-500 PROTECTED

IP67 protected LED strips with 500 lm/m for professional applications with very good color rendering and lifetime



Prewired cables on both sides

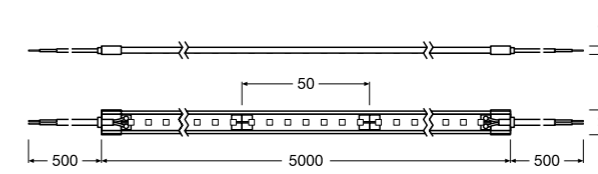

IP67  
 CRI > 90  
 SDCM ≤ 3  
 DIM  
 5 year guarantee  
 LEDVANCE

SHORT PITCH  
 UV RESISTANT  
 SALT MIST  
 TUV SUD  
 UL

E-number	Product name	GTIN (EAN)	COLOR	K	Im	Im	W	W	Im/W	V <sub>DC</sub>
LS SUP-500/927/5/IP67		4058075237261	Warm white	2700	470	2340	5.6	28.0	84.0	24
LS SUP-500/930/5/IP67		4058075237285	White	3000	500	2510	5.6	28.0	90.0	24
LS SUP-500/940/5/IP67		4058075237322	Cool white	4000	500	2515	5.6	28.0	90.0	24
LS SUP-500/960/5/IP67		4058075237346	Daylight	6000	550	2765	5.6	28.0	99.0	24

Product name	PITCH [mm]	α	IP	t <sub>m</sub>	T <sub>a</sub>	L x W x H [mm]	CABLE LENGTH	Imax [mA]	PRICE [EUR]	PRICE METER [EUR]
LS SUP-500/927/5/IP67	140	7.14	120	A	60000	-20...+50	5000x13.0x3.7	500	50.0	
LS SUP-500/930/5/IP67	140	7.14	120	A+	60000	-20...+50	5000x13.0x3.7	500	50.0	
LS SUP-500/940/5/IP67	140	7.14	120	A+	60000	-20...+50	5000x13.0x3.7	500	50.0	
LS SUP-500/960/5/IP67	140	7.14	120	A+	60000	-20...+50	5000x13.0x3.7	500	50.0	

<sup>1</sup> Refer to www.ledvance.com/guarantee for precise conditions | <sup>2</sup> Dimmable with suitable drivers, see also www.ledvance.com/dim | <sup>3</sup> L80/B10 at T<sub>p</sub> 45°C | <sup>4</sup> Recommended retail price excl. VAT

### STRIP ACCESSORIES

Extract from the system components of the extensive LED Strip accessories

► Details see chapter STRIP ACCESSORIES

#### CONNECTORS



LS AY SUP-CP/P2/500  
4058075304413

#### ENDCAPS



LS AY SUP-SE/P + SILICONE SEAL  
4058075304659

#### MOUNTING BRACKETS

### PROFILES

Matching profiles (orange) with corresponding covers and installation accessories

► Details see chapter PROFILES

LS AY SUP-PF01/U/ 16X10/13/1 4058075304741	LS AY SUP-PFS01/16X10/ 13/0,015 4058075304710	LS AY-PW01/U/ 26X8/14/1 4058075278103	LS AY-PW02/UW/ 39X26/14/1 4058075278134	LS AY-PW03/U/ 26X26/14/1 4058075278165	LS AY-PF01/UW/ 22X6/10/1 4058075278196	LS AY-PF02/U/ 16X5/10/1 4058075278226	LS AY-PF03/UW/ 25X7/12/1 4058075278257
LS AY-PF04/U/ 17X7/12/1 4058075278288	LS AY-PM01/UW/ 21,5X12/10/1 4058075278318	LS AY-PM04/UW/ 23X15,5/10/1 4058075278400	LS AY-PM05/U/ 17,5X14,5/10/1 4058075279278	LS AY-PM02/R/ 18X15,5/10/1 4058075278349	LS AY-PM03/E/ 19X19/10/1 4058075278370	LS AY-PM06/E/ 18X18/12/1 4058075279308	

### DRIVERS

Extract from the versatile driver portfolio

► Details see chapter DRIVERS



DR DIM-PFM-40/220-240/24/P  
4058075379176

DR PFM-30/220-240/24/P  
4058075239890

DR VAL-30/220-240/24  
4058075240056

## LED STRIP SUPERIOR-800

LED strips with 800 lm/m for professional applications with very good color rendering and lifetime



Prewired cables on both sides

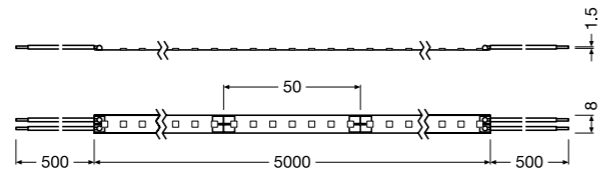

E-number	Product name	GTIN (EAN)	COLOR	K	Im	Im	W	W	lm/W	V <sub>DC</sub>
LS SUP-800/927/5		4058075237186	Warm white	2700	730	3640	7.8	39.0	94.0	24
LS SUP-800/930/5		4058075237223	White	3000	790	3955	7.8	39.0	101.0	24
LS SUP-800/940/5		4058075237247	Cool white	4000	795	3980	7.8	39.0	102.0	24
LS SUP-800/965/5		4058075237308	Daylight	6500	870	4345	7.8	39.0	112.0	24

Product name	PITCH [mm]	∠	IP	t <sub>inj</sub>	T <sub>a</sub>	L x W x H [mm]	CABLE LENGTH	Imax [mA]	PRICE [EUR]	PRICE METER [EUR]
LS SUP-800/927/5	140	7.14	120	A+	60000	-20...+50	5000x8.0x1.5	500	50.0	
LS SUP-800/930/5	140	7.14	120	A+	60000	-20...+50	5000x8.0x1.5	500	50.0	
LS SUP-800/940/5	140	7.14	120	A+	60000	-20...+50	5000x8.0x1.5	500	50.0	
LS SUP-800/965/5	140	7.14	120	A+	60000	-20...+50	5000x8.0x1.5	500	50.0	

<sup>1</sup> Refer to [www.ledvance.com/guarantee](http://www.ledvance.com/guarantee) for precise conditions | <sup>2</sup> Dimmable with suitable drivers, see also [www.ledvance.com/dim](http://www.ledvance.com/dim) | <sup>3</sup> L80/B10 at T<sub>p</sub> 45°C | <sup>4</sup> Recommended retail price excl. VAT

### STRIP ACCESSORIES

Extract from the system components of the extensive LED Strip accessories

► Details see chapter STRIP ACCESSORIES

#### CONNECTORS



LS AY SUP-CP/P2/500  
4058075304413

#### ENDCAPS



LS AY SUP-CSD/P2  
4058075304444

#### MOUNTING BRACKETS



LS AY PFM-8/SMB  
4058075275645

### PROFILES

Matching profiles (orange) with corresponding covers and installation accessories

► Details see chapter PROFILES

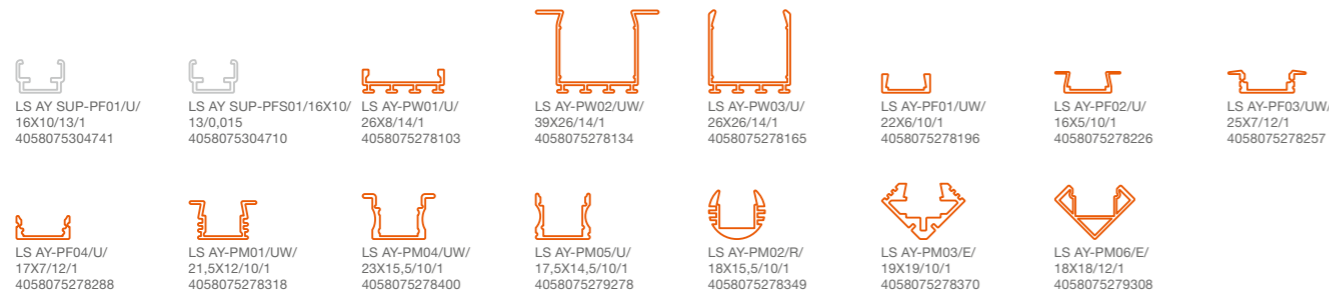

### DRIVERS

Extract from the versatile driver portfolio

► Details see chapter DRIVERS



DR DALI-SUP-80/220-240/24  
4058075421844

DR DIM-PFM-60/220-240/24/P  
4058075379190

DR VAL-60/220-240/24  
4058075240094

## LED STRIP SUPERIOR-800 PROTECTED

IP67 protected LED strips with 800 lm/m for professional applications with very good color rendering and lifetime



Prewired cables on both sides

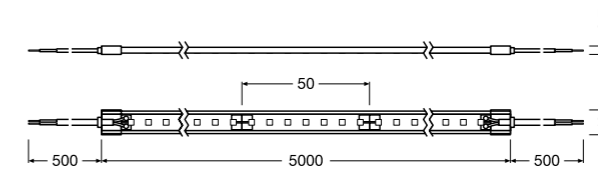

E-number	Product name	GTIN (EAN)	COLOR	K	Im	Im	W	W	lm/W	V <sub>DC</sub>
LS SUP-800/927/5/IP67		4058075237360	Warm white	2700	750	3750	8.8	44.0	85.0	24
LS SUP-800/930/5/IP67		4058075237384	White	3000	805	4000	8.8	44.0	91.0	24
LS SUP-800/940/5/IP67		4058075237407	Cool white	4000	800	4000	8.8	44.0	91.0	24
LS SUP-800/960/5/IP67		4058075237421	Daylight	6000	895	4475	8.8	44.0	101.0	24

Product name	PITCH [mm]	∠	IP	t <sub>inj</sub>	T <sub>a</sub>	L x W x H [mm]	CABLE LENGTH	Imax [mA]	PRICE [EUR]	PRICE METER [EUR]
LS SUP-800/927/5/IP67	140	7.14	120	A	60000	-20...+50	5000x13.0x3.7	500	50.0	
LS SUP-800/930/5/IP67	140	7.14	120	A+	60000	-20...+50	5000x13.0x3.7	500	50.0	
LS SUP-800/940/5/IP67	140	7.14	120	A+	60000	-20...+50	5000x13.0x3.7	500	50.0	
LS SUP-800/960/5/IP67	140	7.14	120	A+	60000	-20...+50	5000x13.0x3.7	500	50.0	

<sup>1</sup> Refer to [www.ledvance.com/guarantee](http://www.ledvance.com/guarantee) for precise conditions | <sup>2</sup> Dimmable with suitable drivers, see also [www.ledvance.com/dim](http://www.ledvance.com/dim) | <sup>3</sup> L80/B10 at T<sub>p</sub> 45°C | <sup>4</sup> Recommended retail price excl. VAT

### STRIP ACCESSORIES

Extract from the system components of the extensive LED Strip accessories

► Details see chapter STRIP ACCESSORIES

#### CONNECTORS



LS AY SUP-CP/P2/500  
4058075304413

#### ENDCAPS



LS AY SUP-SE/P + SILICONE SEAL  
4058075304659

#### MOUNTING BRACKETS

### PROFILES

Matching profiles (orange) with corresponding covers and installation accessories

► Details see chapter PROFILES

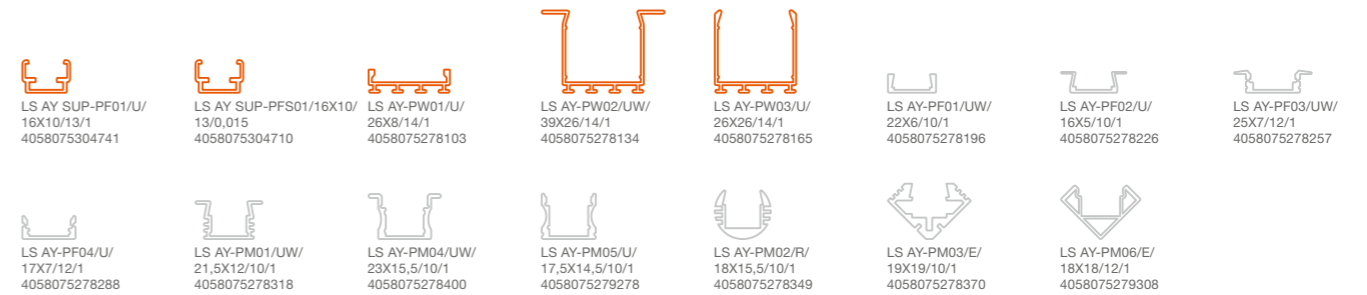

### DRIVERS

Extract from the versatile driver portfolio

► Details see chapter DRIVERS



DR DIM-PFM-60/220-240/24/P  
4058075379190

DR PFM-60/220-240/24/P  
4058075239913

DR VAL-60/220-240/24  
4058075240094

## LED STRIP SUPERIOR-1200

LED strips with 1200 lm/m for professional applications with very good color rendering and lifetime



Prewired cables on both sides

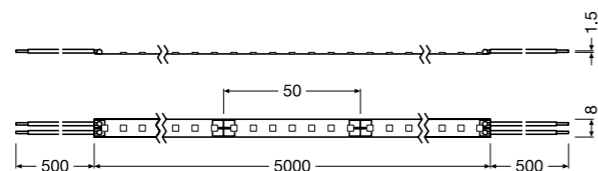

IP00  
 CRI > 90  
 5 year guarantee  
 SDCM ≤ 3  
 DIM



E-number	Product name	GTIN (EAN)	COLOR	K	Im METER	Im	W METER	W	lm/W	V <sub>DC</sub>
LS SUP-1200/927/5		4058075236646	Warm white	2700	1085	5430	11.6	58.0	94.0	24
LS SUP-1200/930/5		4058075236684	White	3000	1175	5880	11.6	58.0	102.0	24
LS SUP-1200/940/5		4058075236721	Cool white	4000	1195	5975	11.6	58.0	103.0	24
LS SUP-1200/965/5		4058075236745	Daylight	6500	1295	6480	11.6	58.0	112.0	24

Product name	PITCH [mm]	∠	IP	t <sub>inj</sub>	T <sub>a</sub>	L x W x H [mm]	CABLE LENGTH	Imax [mA]	PRICE (EUR)	PRICE METER (EUR)
LS SUP-1200/927/5	140	7.14	120	A+	60000	-20...+50	5000x8.0x1.5	500	50.0	
LS SUP-1200/930/5	140	7.14	120	A+	60000	-20...+50	5000x8.0x1.5	500	50.0	
LS SUP-1200/940/5	140	7.14	120	A+	60000	-20...+50	5000x8.0x1.5	500	50.0	
LS SUP-1200/965/5	140	7.14	120	A+	60000	-20...+50	5000x8.0x1.5	500	50.0	

<sup>1</sup> Refer to [www.ledvance.com/guarantee](http://www.ledvance.com/guarantee) for precise conditions | <sup>2</sup> Dimmable with suitable drivers, see also [www.ledvance.com/dim](http://www.ledvance.com/dim) | <sup>3</sup> L80/B10 at T<sub>p</sub> 45°C | <sup>4</sup> Recommended retail price excl. VAT

### STRIP ACCESSORIES

Extract from the system components of the extensive LED Strip accessories

► Details see chapter STRIP ACCESSORIES

#### CONNECTORS



LS AY SUP-CP/P2/500  
4058075304413

#### ENDCAPS



LS AY SUP-CSD/P2  
4058075304444

#### MOUNTING BRACKETS



LS AY PFM-8/SMB  
4058075275645

### PROFILES

Matching profiles (orange) with corresponding covers and installation accessories

► Details see chapter PROFILES

LS AY SUP-PF01/U/16X10/13/1 4058075304741	LS AY SUP-PFS01/16X10/13/0,015 4058075304710	LS AY-PW01/U/26X8/14/1 4058075278103	LS AY-PW02/UW/39X26/14/1 4058075278134	LS AY-PW03/U/26X26/14/1 4058075278165	LS AY-PF01/UW/22X6/10/1 4058075278196	LS AY-PF02/U/16X5/10/1 4058075278226	LS AY-PF03/UW/25X7/12/1 4058075278257
LS AY-PF04/U/17X7/12/1 4058075278288	LS AY-PM01/UW/21,5X12/10/1 4058075278318	LS AY-PM04/UW/23X15,5/10/1 4058075278400	LS AY-PM05/U/17,5X14,5/10/1 4058075279278	LS AY-PM02/RV/18X15,5/10/1 4058075278349	LS AY-PM03/E/19X19/10/1 4058075278370	LS AY-PM06/E/18X18/12/1 4058075279308	

### DRIVERS

Extract from the versatile driver portfolio

► Details see chapter DRIVERS



DR DALI-SUP-150/220-240/24  
4058075421868

DR DIM-PFM-100/220-240/24/P  
4058075240070

DR-VAL-120/220-240/24  
4058075240131

## LED STRIP SUPERIOR-1200 PROTECTED

IP67 protected LED strips with 1200 lm/m for professional applications with very good color rendering and lifetime



Prewired cables on both sides

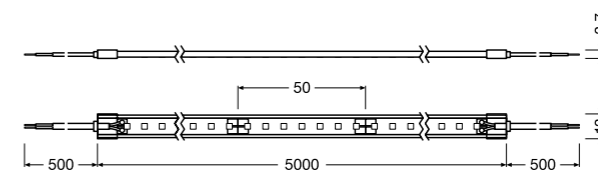

IP67  
 CRI > 90  
 5 year guarantee  
 SDCM ≤ 3  
 DIM



E-number	Product name	GTIN (EAN)	COLOR	K	Im METER	Im	W METER	W	lm/W	V <sub>DC</sub>
LS SUP-1200/927/5/IP67		4058075236783	Warm white	2700	1100	5500	11.6	58.0	94.0	24
LS SUP-1200/930/5/IP67		4058075236820	White	3000	1120	5600	11.6	58.0	96.0	24
LS SUP-1200/940/5/IP67		4058075236844	Cool white	4000	1200	6000	11.6	58.0	103.0	24
LS SUP-1200/960/5/IP67		4058075236868	Daylight	6000	1200	6000	11.6	58.0	103.0	24

Product name	PITCH [mm]	∠	IP	t <sub>inj</sub>	T <sub>a</sub>	L x W x H [mm]	CABLE LENGTH	Imax [mA]	PRICE (EUR)	PRICE METER (EUR)
LS SUP-1200/927/5/IP67	140	7.14	120	A+	60000	-20...+50	5000x13.0x3.7	500	50.0	
LS SUP-1200/930/5/IP67	140	7.14	120	A+	60000	-20...+50	5000x13.0x3.7	500	50.0	
LS SUP-1200/940/5/IP67	140	7.14	120	A+	60000	-20...+50	5000x13.0x3.7	500	50.0	
LS SUP-1200/960/5/IP67	140	7.14	120	A+	60000	-20...+50	5000x13.0x3.7	500	50.0	

<sup>1</sup> Refer to [www.ledvance.com/guarantee](http://www.ledvance.com/guarantee) for precise conditions | <sup>2</sup> Dimmable with suitable drivers, see also [www.ledvance.com/dim](http://www.ledvance.com/dim) | <sup>3</sup> L80/B10 at T<sub>p</sub> 45°C | <sup>4</sup> Recommended retail price excl. VAT

### STRIP ACCESSORIES

Extract from the system components of the extensive LED Strip accessories

► Details see chapter STRIP ACCESSORIES

#### CONNECTORS



LS AY SUP-SE/P + SILICONE SEAL  
4058075304659

#### ENDCAPS



LS AY SUP-SE/P + SILICONE SEAL  
4058075304659

#### MOUNTING BRACKETS

### PROFILES

Matching profiles (orange) with corresponding covers and installation accessories

► Details see chapter PROFILES

LS AY SUP-PF01/U/16X10/13/1 4058075304741	LS AY SUP-PFS01/16X10/13/0,015 4058075304710	LS AY-PW01/U/26X8/14/1 4058075278103	LS AY-PW02/UW/39X26/14/1 4058075278134	LS AY-PW03/U/26X26/14/1 4058075278165	LS AY-PF01/UW/22X6/10/1 4058075278196	LS AY-PF02/U/16X5/10/1 4058075278226	LS AY-PF03/UW/25X7/12/1 4058075278257
LS AY-PF04/U/17X7/12/1 4058075278288	LS AY-PM01/UW/21,5X12/10/1 4058075278318	LS AY-PM04/UW/23X15,5/10/1 4058075278400	LS AY-PM05/U/17,5X14,5/10/1 4058075279278	LS AY-PM02/RV/18X15,5/10/1 4058075278349	LS AY-PM03/E/19X19/10/1 4058075278370	LS AY-PM06/E/18X18/12/1 4058075279308	

### DRIVERS

Extract from the versatile driver portfolio

► Details see chapter DRIVERS



DR DIM-PFM-100/220-240/24/P  
4058075240070

DR-PFM-100/220-240/24/P  
4058075239937

DR-VAL-120/220-240/24  
4058075240131

## LED STRIP SUPERIOR-2000

LED strips with 2000 lm/m for professional applications with very good color rendering and lifetime



Prewired cables on both sides

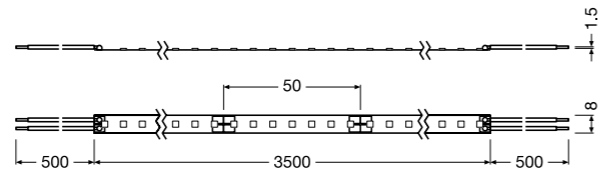

IP00  
 CRI > 90  
 5 year guarantee  
 SDCM ≤ 3  
 DIM

E-number	Product name	GTIN (EAN)	COLOR	K	Im	Im	W	W	lm/W	V <sub>DC</sub>
LS SUP-2000/927/3.5		4058075236769	Warm white	2700	1810	6340	20.0	70.0	90.0	24
LS SUP-2000/930/3.5		4058075236882	White	3000	1975	6910	20.0	70.0	98.0	24
LS SUP-2000/940/3.5		4058075236905	Cool white	4000	2030	7095	20.0	70.0	101.0	24
LS SUP-2000/965/3.5		4058075236929	Daylight	6500	2175	7615	20.0	70.0	108.0	24

Product name	PITCH [mm]	α	IP	t <sub>m</sub>	T <sub>a</sub>	L x W x H [mm]	CABLE LENGTH	Imax [mA]	PRICE [EUR]	PRICE METER [EUR]
LS SUP-2000/927/3.5	140	7.14	120	A+	60000	-20...+50	3500x8.0x1.5	500	50.0	
LS SUP-2000/930/3.5	140	7.14	120	A+	60000	-20...+50	3500x8.0x1.5	500	50.0	
LS SUP-2000/940/3.5	140	7.14	120	A+	60000	-20...+50	3500x8.0x1.5	500	50.0	
LS SUP-2000/965/3.5	140	7.14	120	A+	60000	-20...+50	3500x8.0x1.5	500	50.0	

<sup>1</sup> Refer to www.ledvance.com/guarantee for precise conditions | <sup>2</sup> Dimmable with suitable drivers, see also www.ledvance.com/dim | <sup>3</sup> L80/B10 at T<sub>p</sub> 45°C | <sup>4</sup> Recommended retail price excl. VAT

### STRIP ACCESSORIES

Extract from the system components of the extensive LED Strip accessories

► Details see chapter STRIP ACCESSORIES

#### CONNECTORS



LS AY SUP-CP/P2/500  
4058075304413

#### ENDCAPS



LS AY SUP-CSD/P2  
4058075304444

#### MOUNTING BRACKETS



LS AY PFM-8/SMB  
4058075275645

### PROFILES

Matching profiles (orange) with corresponding covers and installation accessories

► Details see chapter PROFILES

LS AY SUP-PF01/U/16X10/13/1 4058075304741	LS AY SUP-PFS01/16X10/13/0,015 4058075304710	LS AY-PW01/U/26X8/14/1 4058075278103	LS AY-PW02/UW/39X26/14/1 4058075278134	LS AY-PW03/U/26X26/14/1 4058075278165	LS AY-PF01/UW/22X6/10/1 4058075278196	LS AY-PF02/U/16X5/10/1 4058075278226	LS AY-PF03/UW/25X7/12/1 4058075278257
LS AY-PF04/U/17X7/12/1 4058075278288	LS AY-PM01/UW/21,5X12/10/1 4058075278318	LS AY-PM04/UW/23X15,5/10/1 4058075278400	LS AY-PM05/U/17,5X14,5/10/1 4058075279278	LS AY-PM02/RV/18X15,5/10/1 4058075278349	LS AY-PM03/E/19X19/10/1 4058075278370	LS AY-PM06/E/18X18/12/1 4058075279308	

### DRIVERS

Extract from the versatile driver portfolio

► Details see chapter DRIVERS



DR DALI-SUP-150/220-240/24  
4058075421868

DR DIM-PFM-150/220-240/24/P  
4058075240117

DR-VAL-150/220-240/24  
4058075240179

## LED STRIP SUPERIOR-2000 PROTECTED

IP67 protected LED strips with 2000 lm/m for professional applications with very good color rendering and lifetime



Prewired cables on both sides

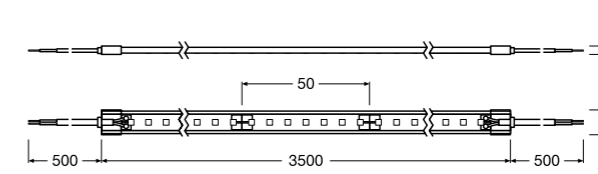

IP67  
 CRI > 90  
 5 year guarantee  
 SDCM ≤ 3  
 DIM

E-number	Product name	GTIN (EAN)	COLOR	K	Im	Im	W	W	lm/W	V <sub>DC</sub>
LS SUP-2000/927/3.5/IP67		4058075237124	Warm white	2700	1850	6475	20.6	72.0	89.0	24
LS SUP-2000/930/3.5/IP67		4058075237148	White	3000	1850	6475	20.6	72.0	89.0	24
LS SUP-2000/940/3.5/IP67		4058075237162	Cool white	4000	2000	7000	20.6	72.0	96.0	24
LS SUP-2000/960/3.5/IP67		4058075237209	Daylight	6000	2000	7000	20.6	72.0	96.0	24

Product name	PITCH [mm]	α	IP	t <sub>m</sub>	T <sub>a</sub>	L x W x H [mm]	CABLE LENGTH	Imax [mA]	PRICE [EUR]	PRICE METER [EUR]
LS SUP-2000/927/3.5/IP67	140	7.14	120	A+	60000	-20...+50	3500x13.0x3.7	500	50.0	
LS SUP-2000/930/3.5/IP67	140	7.14	120	A+	60000	-20...+50	3500x13.0x3.7	500	50.0	
LS SUP-2000/940/3.5/IP67	140	7.14	120	A+	60000	-20...+50	3500x13.0x3.7	500	50.0	
LS SUP-2000/960/3.5/IP67	140	7.14	120	A+	60000	-20...+50	3500x13.0x3.7	500	50.0	

<sup>1</sup> Refer to www.ledvance.com/guarantee for precise conditions | <sup>2</sup> Dimmable with suitable drivers, see also www.ledvance.com/dim | <sup>3</sup> L80/B10 at T<sub>p</sub> 45°C | <sup>4</sup> Recommended retail price excl. VAT

### STRIP ACCESSORIES

Extract from the system components of the extensive LED Strip accessories

► Details see chapter STRIP ACCESSORIES

#### CONNECTORS



LS AY SUP-CP/P2/500  
4058075304413

#### ENDCAPS



LS AY SUP-SE/P + SILICONE SEAL  
4058075304659

#### MOUNTING BRACKETS

### PROFILES

Matching profiles (orange) with corresponding covers and installation accessories

► Details see chapter PROFILES

LS AY SUP-PF01/U/16X10/13/1 4058075304741	LS AY SUP-PFS01/16X10/13/0,015 4058075304710	LS AY-PW01/U/26X8/14/1 4058075278103	LS AY-PW02/UW/39X26/14/1 4058075278134	LS AY-PW03/U/26X26/14/1 4058075278165	LS AY-PF01/UW/22X6/10/1 4058075278196	LS AY-PF02/U/16X5/10/1 4058075278226	LS AY-PF03/UW/25X7/12/1 4058075278257
LS AY-PF04/U/17X7/12/1 4058075278288	LS AY-PM01/UW/21,5X12/10/1 4058075278318	LS AY-PM04/UW/23X15,5/10/1 4058075278400	LS AY-PM05/U/17,5X14,5/10/1 4058075279278	LS AY-PM02/RV/18X15,5/10/1 4058075278349	LS AY-PM03/E/19X19/10/1 4058075278370	LS AY-PM06/E/18X18/12/1 4058075279308	

### DRIVERS

Extract from the versatile driver portfolio

► Details see chapter DRIVERS



DR DIM-PFM-150/220-240/24/P  
4058075240117

DR-PFM-150/220-240/24/P  
4058075239975

DR-VAL-150/220-240/24  
4058075240179

# WHITE – WHENEVER, WHEREVER LED STRIPS SUPERIOR CLASS TUNABLE WHITE

SUPERIOR CLASS

TUNABLE WHITE

There are many white light colors in each Tunable White (TW) LED Strip. A controller allows users to dynamically adjust the color temperature to suit their needs, from cold-white, activating 6,500 kelvin to warm-white, cozy 2,700 kelvin. This not only increases the range of applications but can also contribute to personal well-being. Excellent color rendering of over CRI 90 and various types of protection for indoor and outdoor lighting (IP67) add to the options.

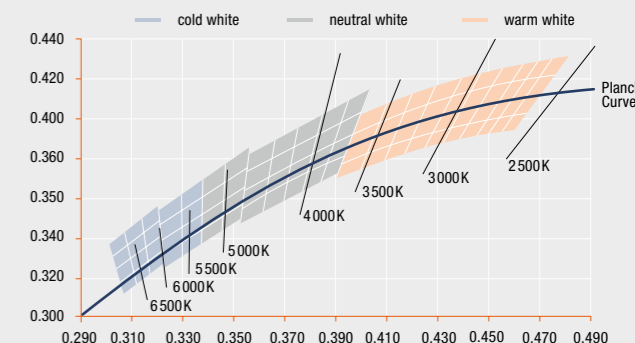

- A life of up to 50,000 hours<sup>1</sup>
- Color rendering index CRI ≥ 90
- Color consistency SDCM ≤ 4
- Luminous flux of up to 2,000 lm/m
- Adjustable color temperatures via Tunable White: 2,700 to 6,500 K
- Type of protection IP 00/67
- Salt mist resistant (to IEC 60068-2-52) and UV resistant (to IEC 60068-2-5) at IP67
- ENEC and TÜV approval
- 5-year guarantee<sup>2</sup>

### ACTIVATING DURING THE DAY

Cold white light with a color temperature of 6,500 kelvin has an energizing effect on the human organism. This makes it ideal for all areas where people need to focus on their work. And also wherever natural daylight needs to be supplemented and enhanced by artificial light.

### ATMOSPHERIC IN THE EVENING

Warm white light with a color temperature of 2,700 kelvin creates a welcoming atmosphere and is ideal for all areas where you want to relax. In the evening, it allows for cozy and relaxed shopping, for example.

### TAKING THE SUN AS AN EXAMPLE

With Tunable White LED Strips, the spectrum of natural daylight can be simulated in its full bandwidth between 2,700 kelvin and 6,500 kelvin. This makes the strips an option for dynamic lighting which addresses people's lighting needs at certain times of the day.

<sup>1</sup> L70/B50 at T<sub>c</sub> ≤ 85 °C | <sup>2</sup> For precise terms and conditions go to [www.ledvance.com/guarantee](http://www.ledvance.com/guarantee)

### CONNECTION DIAGRAM FOR TUNABLE WHITE LED STRIP

**Important!**  
In combination with the multi-channel controller and the TW control elements, 24V DC LED drivers ensure correct and easy handling of tunable white operation.

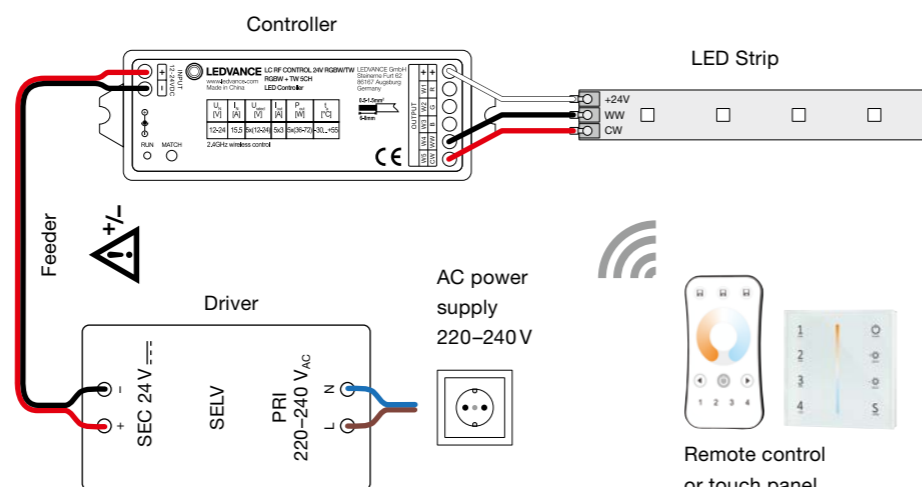

### CHECK: THIS IS HOW YOUR TUNABLE WHITE LED STRIP SYSTEM WORKS

The Tunable White versions of the LEDVANCE LED Strips can be installed to suit individual planning. However, the following components are essential for a functioning Tunable White system.

#### System components for LEDVANCE TW LED STRIP:

- Multichannel controller: LC RF Controller 24V RGBW/TW
- TW control elements: remote control (LC RF REMOTE TW) and/or touch panel (LC RF TOUCH PANEL TW)

Alternatively, you can use a DALI or DMX system.

### PRODUCT BENEFITS

- Great design freedom thanks to long, flexible TW LED Strips
- Easy installation and tool-free connection
- Simple installation thanks to adhesive tape
- Maximum flexibility thanks to a wide range of accessories
- Simple connection thanks to integrated cables on both sides
- Protected LED Strips suitable for use in damp environments thanks to high degree of protection (IP67)

### APPLICATIONS

- General indoor lighting
- Protected LED Strips for general outdoor lighting (IP67)
- Hotels
- Offices, sales and conference rooms
- Decorative cove lighting

# LED STRIP SUPERIOR-2000 TW

Tunable White LED strips with 2000 lm/m for professional applications with very good color rendering and lifetime



Prewired cables on both sides

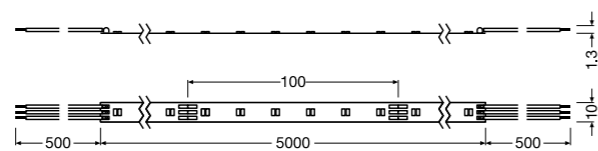

E-number	Product name	GTIN (EAN)	COLOR	K	Im METER	Im	W METER	W	lm/W	V <sub>DC</sub>	
LS SUP-2000/TW/927-965/5		4058075436084	Tunable White	2700...6500	994	1058	9924	22.5	112.5	87.0	24

Product name	METER	PITCH [mm]	°	IP	t <sub>in</sub>	T <sub>a</sub>	L x W x H [mm]	CABLE LENGTH	Imax [mA]	PRICE (EUR)	PRICE (EUR)
LS SUP-2000/TW/927-965/5	60	16.67	120	A	50000	-20...+55	5000x10.0x2.0	500	100.0		

<sup>1</sup> Refer to www.ledvance.com/guarantee for precise conditions | <sup>2</sup> Dimmable with suitable drivers, see also www.ledvance.com/dim | <sup>3</sup> L70/B50 at Tc max. 85 °C | <sup>4</sup> Recommended retail price excl. VAT

# LED STRIP SUPERIOR-2000 TW PROTECTED

IP67 protected Tunable White LED strips with 2000 lm/m for professional applications with very good color rendering and lifetime



Prewired cables on both sides

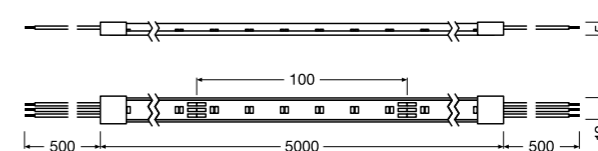

E-number	Product name	GTIN (EAN)	COLOR	K	Im METER	Im	W METER	W	lm/W	V <sub>DC</sub>	
LS SUP-2000/TW/927-965/5/IP67		4058075436008	Tunable White	2700...6500	950	1015	9762	22.5	112.5	86.0	24

Product name	METER	PITCH [mm]	°	IP	t <sub>in</sub>	T <sub>a</sub>	L x W x H [mm]	CABLE LENGTH	Imax [mA]	PRICE (EUR)	PRICE (EUR)
LS SUP-2000/TW/927-965/5/IP67	60	16.67	120	A	50000	-20...+55	5000x12.0x5.0	500	100.0		

<sup>1</sup> Refer to www.ledvance.com/guarantee for precise conditions | <sup>2</sup> Dimmable with suitable drivers, see also www.ledvance.com/dim | <sup>3</sup> L70/B50 at Tc max. 85 °C | <sup>4</sup> Recommended retail price excl. VAT

## STRIP ACCESSORIES

Extract from the system components of the extensive LED Strip accessories

► Details see chapter STRIP ACCESSORIES

### CONNECTORS



### ENDCAPS

### MOUNTING BRACKETS



## PROFILES

Matching profiles (orange) with corresponding covers and installation accessories

► Details see chapter PROFILES

 LS AY SUP-PF01/U/ 16X10/13/1 4058075304741	 LS AY SUP-PFS01/16X10/ 13/0,015 4058075304710	 LS AY-PW01/U/ 26X8/14/1 4058075278103	 LS AY-PW02/UW/ 39X26/14/1 4058075278134	 LS AY-PW03/U/ 26X26/14/1 4058075278165	 LS AY-PF01/UW/ 22X6/10/1 4058075278196	 LS AY-PF02/U/ 16X5/10/1 4058075278226	 LS AY-PF03/UW/ 25X7/12/1 4058075278257
 LS AY-PF04/U/ 17X7/12/1 4058075278288	 LS AY-PM01/UW/ 21,5X12/10/1 4058075278318	 LS AY-PM04/UW/ 23X15,5/10/1 4058075278400	 LS AY-PM05/U/ 17,5X14,5/10/1 4058075279278	 LS AY-PM02/RV/ 18X15,5/10/1 4058075278349	 LS AY-PM03/E/ 19X19/10/1 4058075278370	 LS AY-PM06/E/ 18X18/12/1 4058075279308	

## DRIVERS

Extract from the versatile driver portfolio

► Details see chapter DRIVERS

 DR-VAL-150/220-240/24 4058075240179	 LC RF CONTROL 24V RGBW/TW 4058075435834	 LC RF TOUCH PANEL TW 4058075435940	 LC RF REMOTE TW 4058075435926
--	--	---	--------------------------------------

## STRIP ACCESSORIES

Extract from the system components of the extensive LED Strip accessories

► Details see chapter STRIP ACCESSORIES

### CONNECTORS



### ENDCAPS



### MOUNTING BRACKETS



## PROFILES

Matching profiles (orange) with corresponding covers and installation accessories

► Details see chapter PROFILES

 LS AY SUP-PF01/U/ 16X10/13/1 4058075304741	 LS AY SUP-PFS01/16X10/ 13/0,015 4058075304710	 LS AY-PW01/U/ 26X8/14/1 4058075278103	 LS AY-PW02/UW/ 39X26/14/1 4058075278134	 LS AY-PW03/U/ 26X26/14/1 4058075278165	 LS AY-PF01/UW/ 22X6/10/1 4058075278196	 LS AY-PF02/U/ 16X5/10/1 4058075278226	 LS AY-PF03/UW/ 25X7/12/1 4058075278257
 LS AY-PF04/U/ 17X7/12/1 4058075278288	 LS AY-PM01/UW/ 21,5X12/10/1 4058075278318	 LS AY-PM04/UW/ 23X15,5/10/1 4058075278400	 LS AY-PM05/U/ 17,5X14,5/10/1 4058075279278	 LS AY-PM02/RV/ 18X15,5/10/1 4058075278349	 LS AY-PM03/E/ 19X19/10/1 4058075278370	 LS AY-PM06/E/ 18X18/12/1 4058075279308	

## DRIVERS

Extract from the versatile driver portfolio

► Details see chapter DRIVERS

 DR-PFM-250/220-240/24/P 4058075240032	 LC RF CONTROL 24V RGBW/TW 4058075435834	 LC RF TOUCH PANEL TW 4058075435940	 LC RF REMOTE TW 4058075435926
--	--	---	--------------------------------------



# ALLROUNDERS IN THE PROFESSIONAL LEAGUE

## THE PERFORMANCE CLASS RANGE AT A GLANCE

PERFORMANCE CLASS

WHITE

You can't go wrong with LEDVANCE LED Strips Performance Class. Because the products in this range combine high quality with demand-based performance. The wide choice of color temperatures and luminous fluxes covers a huge variety of applications. Different IP ratings are available to meet the vast majority of requirements. And of course they offer impressive efficiency and durability. The Performance Class is therefore the ideal choice for standard commercial applications from offices to hospitality, indoors and outdoors.



- A life of up to 35,000 hours<sup>1</sup>
- Color rendering index CRI ≥ 80
- Color consistency SDCM ≤ 4
- Luminous fluxes from 300 to 2,000 lm/m – tailored for ambient, cove and general lighting
- 4 color temperatures: 2,700 K, 3,000 K, 4,000 K, 6,500 K
- Type of protection IP 00/66
- Salt mist resistant (to IEC 60068-2-52) and UV resistant (to IEC 60068-2-5) at IP66
- TÜV approval
- 3-year guarantee<sup>2</sup>

### AMBIENT LIGHTING

Creating stylish and efficient outdoor lighting could not be easier with LED Strips Performance Class. Highlighting the edges of planters with IP66 lighting strips in warm white is just one of many examples. Combined with a matching profile, LEDVANCE LED Strips Performance Class protected at 2,700 K, 600 lm/m and IP66 are ideal for atmospheric accent lighting in outdoor areas.

### COVE LIGHTING

Light as a source of ideas. This room within a room is used as a think tank, with the indirect neutral white cove lighting bright enough to serve as general lighting. At the same time, it is both decorative and inspirational. All made possible by LEDVANCE LED Strips Performance Class with 4,000 K, 1,000 lm/m and IP00. Space-saving profiles and diffuse covers equipped with the appropriate LED Strips create a pleasant working atmosphere.

### GENERAL LIGHTING

LED Strips Performance Class looks great even as general lighting in large open-plan offices. They provide high-intensity light, accentuating architectural features on walls and ceilings – ideally in energizing daylight white. But that's not all. LEDVANCE LED Strips Performance Class with 6,500 K, 2,000 lm/m and IP00 are suitable for the efficient illumination of workplaces and can contribute to the well-being of employees.

<sup>1</sup> L70/B50 at T<sub>c</sub> max: 75 °C | <sup>2</sup> For precise terms and conditions go to [www.ledvance.com/guarantee](http://www.ledvance.com/guarantee)



### PRODUCT BENEFITS

- Great design freedom thanks to long, flexible LED Strips
- Easy installation and tool-free connection
- Easy mounting on many smooth surfaces with self-adhesive tape
- Protected LED Strips suitable for use in damp environments thanks to high degree of protection (IP66)
- Maximum flexibility thanks to a wide range of accessories
- Simple connection thanks to integrated cables on both sides

### APPLICATIONS

- General indoor lighting
- Protected LED Strips for general outdoor lighting (IP66)
- Industry
- Offices, sales and conference rooms
- Architectural lighting
- Decorative lighting

## LED STRIP PERFORMANCE-300

High performance LED strips with 300 lm/m for high requirements



Prewired cables on both sides

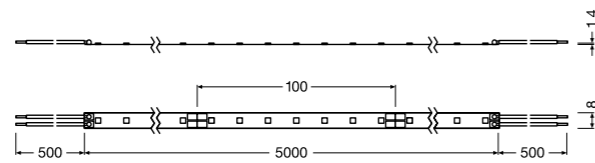

IP00  
 CRI >80  
 SDCM ≤4  
 DIM  
 3 year guarantee  
 LEDVANCE



E-number	Product name	GTIN (EAN)	COLOR	K	Im	Im	W	W	lm/W	V <sub>DC</sub>
LS PFM-300/827/5		4058075236387	Warm white	2700	320	1600	2.7	13.5	118.5	24
LS PFM-300/830/5		4058075236424	White	3000	320	1600	2.7	13.5	118.5	24
LS PFM-300/840/5		4058075236523	Cool white	4000	350	1750	2.7	13.5	129.6	24
LS PFM-300/865/5		4058075236585	Daylight	6500	350	1750	2.7	13.5	129.6	24

Product name	PITCH [mm]	α	IP	t <sub>inj</sub>	T <sub>a</sub>	L x W x H [mm]	CABLE LENGTH	Imax [mA]	PRICE [EUR]	PRICE METER [EUR]
LS PFM-300/827/5	70	14.30	120	A+	35000	-15...+45	5000x8.0x1.4	500	100.0	
LS PFM-300/830/5	70	14.30	120	A+	35000	-15...+45	5000x8.0x1.4	500	100.0	
LS PFM-300/840/5	70	14.30	120	A+	35000	-15...+45	5000x8.0x1.4	500	100.0	
LS PFM-300/865/5	70	14.30	120	A+	35000	-15...+45	5000x8.0x1.4	500	100.0	

<sup>1</sup> Refer to www.ledvance.com/guarantee for precise conditions | <sup>2</sup> Dimmable with suitable drivers, see also www.ledvance.com/dim | <sup>3</sup> L70/B50 at Tc max. 75 °C | <sup>4</sup> Recommended retail price excl. VAT

### STRIP ACCESSORIES

Extract from the system components of the extensive LED Strip accessories

► Details see chapter STRIP ACCESSORIES

#### CONNECTORS



LS AY PFM-CP/P2/500  
4058075272200



LS AY PFM-CSD/P2  
4058075275393

#### ENDCAPS



LS AY PFM-8/SMB  
4058075275645

#### MOUNTING BRACKETS

### PROFILES

Matching profiles (orange) with corresponding covers and installation accessories

► Details see chapter PROFILES

 LS AY SUP-PF01/U/16X10/13/1 4058075304741	 LS AY SUP-PFS01/16X10/13/0,015 4058075304710	 LS AY-PW01/U/26X8/14/1 4058075278103	 LS AY-PW02/U/39X26/14/1 4058075278134	 LS AY-PW03/U/26X26/14/1 4058075278165	 LS AY-PF01/UW/22X6/10/1 4058075278196	 LS AY-PF02/U/16X5/10/1 4058075278226	 LS AY-PF03/UW/25X7/12/1 4058075278257
 LS AY-PF04/U/17X7/12/1 4058075278288	 LS AY-PM01/UW/21,5X12/10/1 4058075278318	 LS AY-PM04/UW/23X15,5/10/1 4058075278400	 LS AY-PM05/U/17,5X14,5/10/1 4058075279278	 LS AY-PM02/R/18X15,5/10/1 4058075278349	 LS AY-PM03/E/19X19/10/1 4058075278370	 LS AY-PM06/E/18X18/12/1 4058075279308	

### DRIVERS

Extract from the versatile driver portfolio

► Details see chapter DRIVERS

 DR DALI-SUP-45/220-240/24 4058075421820	 DR DIM-PFM-40/220-240/24/P 4058075379176	 DR VAL-30/220-240/24 4058075240056
--	---	---

## LED STRIP PERFORMANCE-300 PROTECTED

High performance IP66 protected LED strips with 300 lm/m for high requirements



Prewired cables on both sides

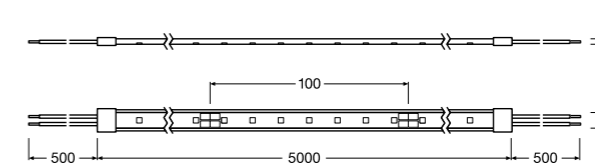

IP66  
 CRI >80  
 SDCM ≤4  
 DIM  
 3 year guarantee  
 LEDVANCE



E-number	Product name	GTIN (EAN)	COLOR	K	Im	Im	W	W	lm/W	V <sub>DC</sub>
LS PFM-300/827/5/IP66		4058075236622	Warm white	2700	300	1500	2.7	13.5	111.1	24
LS PFM-300/830/5/IP66		4058075236660	White	3000	300	1500	2.7	13.5	111.1	24
LS PFM-300/840/5/IP66		4058075236806	Cool white	4000	330	1650	2.7	13.5	122.2	24
LS PFM-300/865/5/IP66		4058075236707	Daylight	6500	330	1650	2.7	13.5	122.2	24

Product name	PITCH [mm]	α	IP	t <sub>inj</sub>	T <sub>a</sub>	L x W x H [mm]	CABLE LENGTH	Imax [mA]	PRICE [EUR]	PRICE METER [EUR]
LS PFM-300/827/5/IP66	70	14.30	105	A+	35000	-15...+45	5000x10.0x4.5	500	100.0	
LS PFM-300/830/5/IP66	70	14.30	105	A+	35000	-15...+45	5000x10.0x4.5	500	100.0	
LS PFM-300/840/5/IP66	70	14.30	105	A+	35000	-15...+45	5000x10.0x4.5	500	100.0	
LS PFM-300/865/5/IP66	70	14.30	105	A+	35000	-15...+45	5000x10.0x4.5	500	100.0	

<sup>1</sup> Refer to www.ledvance.com/guarantee for precise conditions | <sup>2</sup> Dimmable with suitable drivers, see also www.ledvance.com/dim | <sup>3</sup> L70/B50 at Tc max. 75 °C | <sup>4</sup> Recommended retail price excl. VAT

### STRIP ACCESSORIES

Extract from the system components of the extensive LED Strip accessories

► Details see chapter STRIP ACCESSORIES

#### CONNECTORS



LS AY PFM-CP/P2/500/P  
4058075272958



LS AY PFM-CSD/P2/P  
4058075275485



LS AY PFM-10/SE/P SIL-SEAL  
4058075275744

#### ENDCAPS



LS AY PFM-10/SMB  
4058075275876

#### MOUNTING BRACKETS

### PROFILES

Matching profiles (orange) with corresponding covers and installation accessories

► Details see chapter PROFILES

 LS AY SUP-PF01/U/16X10/13/1 4058075304741	 LS AY SUP-PFS01/16X10/13/0,015 4058075304710	 LS AY-PW01/U/26X8/14/1 4058075278103	 LS AY-PW02/U/39X26/14/1 4058075278134	 LS AY-PW03/U/26X26/14/1 4058075278165	 LS AY-PF01/UW/22X6/10/1 4058075278196	 LS AY-PF02/U/16X5/10/1 4058075278226	 LS AY-PF03/UW/25X7/12/1 4058075278257
 LS AY-PF04/U/17X7/12/1 4058075278288	 LS AY-PM01/UW/21,5X12/10/1 4058075278318	 LS AY-PM04/UW/23X15,5/10/1 4058075278400	 LS AY-PM05/U/17,5X14,5/10/1 4058075279278	 LS AY-PM02/R/18X15,5/10/1 4058075278349	 LS AY-PM03/E/19X19/10/1 4058075278370	 LS AY-PM06/E/18X18/12/1 4058075279308	

### DRIVERS

Extract from the versatile driver portfolio

► Details see chapter DRIVERS

 DR DIM-PFM-40/220-240/24/P 4058075379176	 DR PFM-30/220-240/24 4058075239890	 DR VAL-30/220-240/24 4058075240056
---	---	---

## LED STRIP PERFORMANCE-600

High performance LED strips with 600 lm/m for high requirements



Prewired cables on both sides

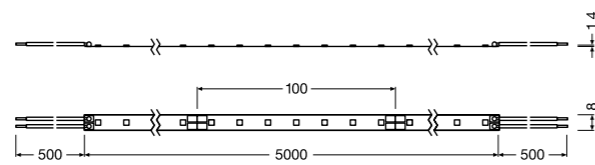

IP00  
 CRI >80  
 SDCM ≤4  
 DIM  
 3 year guarantee  
 LEDVANCE



E-number	Product name	GTIN (EAN)	COLOR	K	Im METER	Im	W METER	W	lm/W	V <sub>DC</sub>
	LS PFM-600/827/5	4058075236400	Warm white	2700	690	3450	5.4	27.0	127.8	24
	LS PFM-600/830/5	4058075236448	White	3000	700	3500	5.4	27.0	129.6	24
	LS PFM-600/840/5	4058075236486	Cool white	4000	750	3750	5.4	27.0	138.9	24
	LS PFM-600/865/5	4058075236547	Daylight	6500	750	3750	5.4	27.0	138.9	24

Product name	PITCH [mm]	∠	IP	t <sub>inj</sub>	T <sub>a</sub>	L x W x H [mm]	CABLE LENGTH	Imax [mA]	PRICE [EUR]	PRICE METER [EUR]
LS PFM-600/827/5	70	14.30	120	A+	35000	-15...+45	5000x8.0x1.4	500	100.0	
LS PFM-600/830/5	70	14.30	120	A+	35000	-15...+45	5000x8.0x1.4	500	100.0	
LS PFM-600/840/5	70	14.30	120	A++	35000	-15...+45	5000x8.0x1.4	500	100.0	
LS PFM-600/865/5	70	14.30	120	A++	35000	-15...+45	5000x8.0x1.4	500	100.0	

<sup>1</sup> Refer to www.ledvance.com/guarantee for precise conditions | <sup>2</sup> Dimmable with suitable drivers, see also www.ledvance.com/dim | <sup>3</sup> L70/B50 at Tc max. 75 °C | <sup>4</sup> Recommended retail price excl. VAT

### STRIP ACCESSORIES

Extract from the system components of the extensive LED Strip accessories

► Details see chapter STRIP ACCESSORIES

#### CONNECTORS



#### ENDCAPS



#### MOUNTING BRACKETS



### PROFILES

Matching profiles (orange) with corresponding covers and installation accessories

► Details see chapter PROFILES

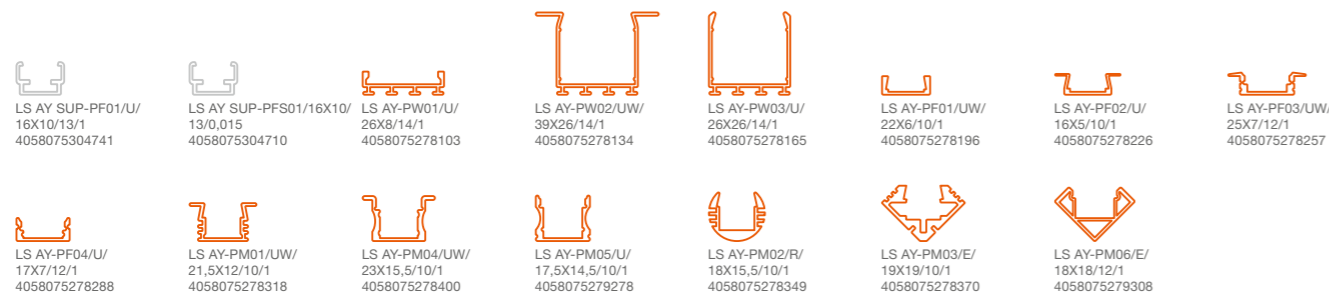

### DRIVERS

Extract from the versatile driver portfolio

► Details see chapter DRIVERS



## LED STRIP PERFORMANCE-600 PROTECTED

High performance IP66 protected LED strips with 600 lm/m for high requirements



Prewired cables on both sides

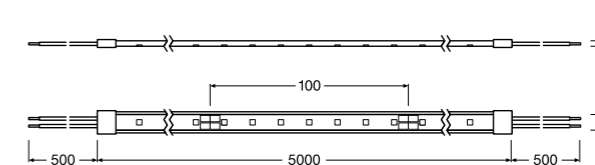

IP66  
 CRI >80  
 SDCM ≤4  
 DIM  
 3 year guarantee  
 LEDVANCE



E-number	Product name	GTIN (EAN)	COLOR	K	Im METER	Im	W METER	W	lm/W	V <sub>DC</sub>
	LS PFM-600/827/5/IP66	4058075236943	Warm white	2700	650	3250	5.4	27.0	120.4	24
	LS PFM-600/830/5/IP66	4058075236967	White	3000	660	3300	5.4	27.0	122.2	24
	LS PFM-600/840/5/IP66	4058075236981	Cool white	4000	710	3550	5.4	27.0	131.5	24
	LS PFM-600/865/5/IP66	4058075237001	Daylight	6500	710	3550	5.4	27.0	131.5	24

Product name	PITCH [mm]	∠	IP	t <sub>inj</sub>	T <sub>a</sub>	L x W x H [mm]	CABLE LENGTH	Imax [mA]	PRICE [EUR]	PRICE METER [EUR]
LS PFM-600/827/5/IP66	70	14.30	105	A+	35000	-15...+45	5000x10.0x4.5	500	100.0	
LS PFM-600/830/5/IP66	70	14.30	105	A+	35000	-15...+45	5000x10.0x4.5	500	100.0	
LS PFM-600/840/5/IP66	70	14.30	105	A++	35000	-15...+45	5000x10.0x4.5	500	100.0	
LS PFM-600/865/5/IP66	70	14.30	105	A++	35000	-15...+45	5000x10.0x4.5	500	100.0	

<sup>1</sup> Refer to www.ledvance.com/guarantee for precise conditions | <sup>2</sup> Dimmable with suitable drivers, see also www.ledvance.com/dim | <sup>3</sup> L70/B50 at Tc max. 75 °C | <sup>4</sup> Recommended retail price excl. VAT

### STRIP ACCESSORIES

Extract from the system components of the extensive LED Strip accessories

► Details see chapter STRIP ACCESSORIES

#### CONNECTORS



#### ENDCAPS



#### MOUNTING BRACKETS



### PROFILES

Matching profiles (orange) with corresponding covers and installation accessories

► Details see chapter PROFILES

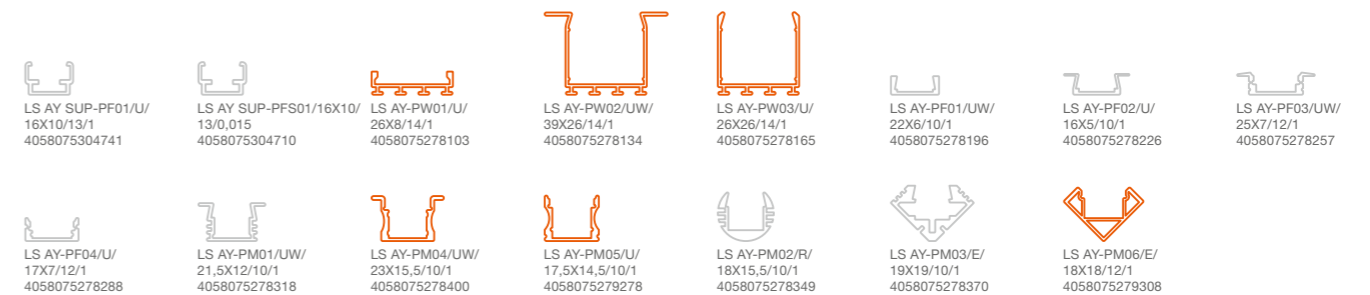

### DRIVERS

Extract from the versatile driver portfolio

► Details see chapter DRIVERS



## LED STRIP PERFORMANCE-1000

High performance LED strips with 1000 lm/m for high requirements



Prewired cables on both sides

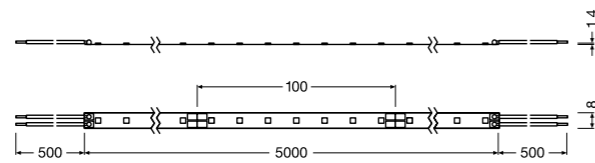

IP00  
 CRI >80  
 LEDVANCE 3 year guarantee  
 SDCM ≤4  
 DIM



E-number	Product name	GTIN (EAN)	COLOR	K	Im METER	Im	W METER	W	lm/W	V <sub>DC</sub>
LS PFM-1000/827/5		4058075235960	Warm white	2700	970	4850	8.1	40.5	119.8	24
LS PFM-1000/830/5		4058075235984	White	3000	990	4950	8.1	40.5	122.2	24
LS PFM-1000/840/5		4058075236004	Cool white	4000	1000	5000	8.1	40.5	123.5	24
LS PFM-1000/865/5		4058075236028	Daylight	6500	1000	5000	8.1	40.5	123.5	24

Product name	PITCH [mm]	∠	IP	t <sub>inj</sub>	T <sub>a</sub>	L x W x H [mm]	CABLE LENGTH	Imax [mA]	PRICE [EUR]	PRICE METER [EUR]
LS PFM-1000/827/5	70	14.30	120	A+	35000	-15...+45	5000x8.0x1.4	500	100.0	
LS PFM-1000/830/5	70	14.30	120	A+	35000	-15...+45	5000x8.0x1.4	500	100.0	
LS PFM-1000/840/5	70	14.30	120	A+	35000	-15...+45	5000x8.0x1.4	500	100.0	
LS PFM-1000/865/5	70	14.30	120	A+	35000	-15...+45	5000x8.0x1.4	500	100.0	

<sup>1</sup> Refer to www.ledvance.com/guarantee for precise conditions | <sup>2</sup> Dimmable with suitable drivers, see also www.ledvance.com/dim | <sup>3</sup> L70/B50 at Tc max. 75 °C | <sup>4</sup> Recommended retail price excl. VAT

### STRIP ACCESSORIES

Extract from the system components of the extensive LED Strip accessories

► Details see chapter STRIP ACCESSORIES

#### CONNECTORS



LS AY PFM-CP/P2/500  
4058075272200



LS AY PFM-CSD/P2  
4058075275393

#### ENDCAPS

#### MOUNTING BRACKETS



LS AY PFM-8/SMB  
4058075275645

### PROFILES

Matching profiles (orange) with corresponding covers and installation accessories

► Details see chapter PROFILES

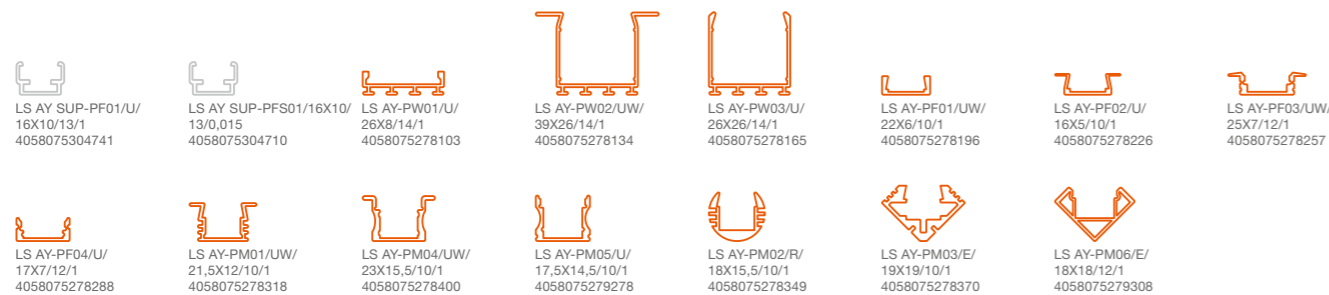

### DRIVERS

Extract from the versatile driver portfolio

► Details see chapter DRIVERS



## LED STRIP PERFORMANCE-1000 PROTECTED

High performance IP66 protected LED strips with 1000 lm/m for high requirements



Prewired cables on both sides

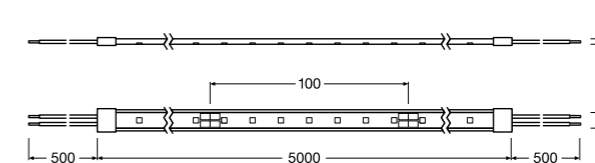

IP66  
 CRI >80  
 LEDVANCE 3 year guarantee  
 SDCM ≤4  
 DIM



E-number	Product name	GTIN (EAN)	COLOR	K	Im METER	Im	W METER	W	lm/W	V <sub>DC</sub>
LS PFM-1000/827/5/IP66		4058075236042	Warm white	2700	920	4600	8.1	40.5	113.6	24
LS PFM-1000/830/5/IP66		4058075236066	White	3000	940	4700	8.1	40.5	116.0	24
LS PFM-1000/840/5/IP66		4058075236080	Cool white	4000	950	4750	8.1	40.5	117.3	24
LS PFM-1000/865/5/IP66		4058075236103	Daylight	6500	950	4750	8.1	40.5	117.3	24

Product name	PITCH [mm]	∠	IP	t <sub>inj</sub>	T <sub>a</sub>	L x W x H [mm]	CABLE LENGTH	Imax [mA]	PRICE [EUR]	PRICE METER [EUR]
LS PFM-1000/827/5/IP66	70	14.30	105	A+	35000	-15...+45	5000x10.0x4.5	500	100.0	
LS PFM-1000/830/5/IP66	70	14.30	105	A+	35000	-15...+45	5000x10.0x4.5	500	100.0	
LS PFM-1000/840/5/IP66	70	14.30	105	A+	35000	-15...+45	5000x10.0x4.5	500	100.0	
LS PFM-1000/865/5/IP66	70	14.30	105	A+	35000	-15...+45	5000x10.0x4.5	500	100.0	

<sup>1</sup> Refer to www.ledvance.com/guarantee for precise conditions | <sup>2</sup> Dimmable with suitable drivers, see also www.ledvance.com/dim | <sup>3</sup> L70/B50 at Tc max. 75 °C | <sup>4</sup> Recommended retail price excl. VAT

### STRIP ACCESSORIES

Extract from the system components of the extensive LED Strip accessories

► Details see chapter STRIP ACCESSORIES

#### CONNECTORS



LS AY PFM-CP/P2/500/P  
4058075272958



LS AY PFM-CSD/P2/P  
4058075275485

#### ENDCAPS



LS AY PFM-10/SE/P SIL-SEAL  
4058075275744

#### MOUNTING BRACKETS



LS AY PFM-10/SMB  
4058075275676

### PROFILES

Matching profiles (orange) with corresponding covers and installation accessories

► Details see chapter PROFILES

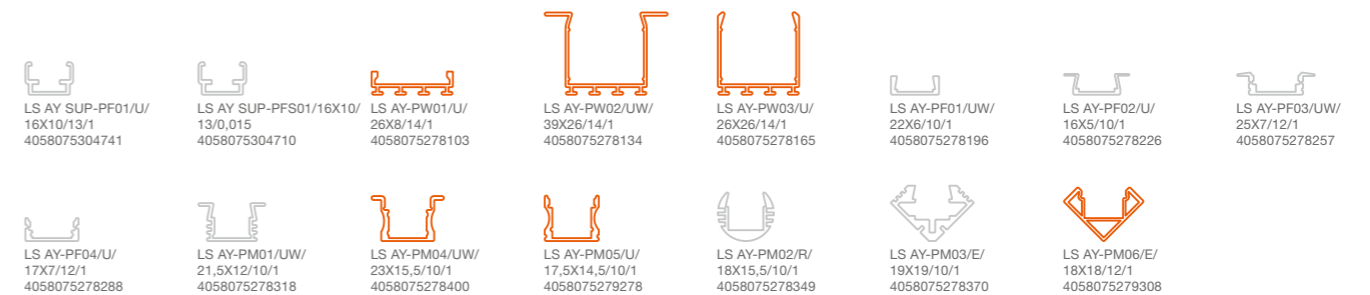

### DRIVERS

Extract from the versatile driver portfolio

► Details see chapter DRIVERS



## LED STRIP PERFORMANCE-1500

High performance LED strips with 1500 lm/m for high requirements



Prewired cables on both sides

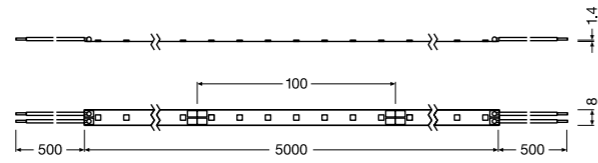

IP00  
 CRI >80  
 3 year guarantee  
 SDCM ≤4  
 DIM



E-number	Product name	GTIN (EAN)	COLOR	K	Im	Im	W	W	Im/W	V <sub>DC</sub>
	LS PFM-1500/827/5	4058075236141	Warm white	2700	1350	6750	11.6	58.0	116.4	24
	LS PFM-1500/830/5	4058075236226	White	3000	1400	7000	11.6	58.0	120.7	24
	LS PFM-1500/840/5	4058075236240	Cool white	4000	1500	7500	11.6	58.0	129.3	24
	LS PFM-1500/865/5	4058075236264	Daylight	6500	1500	7500	11.6	58.0	129.3	24

Product name	PITCH [mm]	α	IP	t <sub>inj</sub>	T <sub>a</sub>	L x W x H [mm]	CABLE LENGTH	Imax [mA]	PRICE [EUR]	PRICE METER [EUR]
LS PFM-1500/827/5	70	14.30	120	A+	35000	-15...+45	5000x8.0x1.4	500	100.0	
LS PFM-1500/830/5	70	14.30	120	A+	35000	-15...+45	5000x8.0x1.4	500	100.0	
LS PFM-1500/840/5	70	14.30	120	A+	35000	-15...+45	5000x8.0x1.4	500	100.0	
LS PFM-1500/865/5	70	14.30	120	A+	35000	-15...+45	5000x8.0x1.4	500	100.0	

<sup>1</sup> Refer to [www.ledvance.com/guarantee](http://www.ledvance.com/guarantee) for precise conditions | <sup>2</sup> Dimmable with suitable drivers, see also [www.ledvance.com/dim](http://www.ledvance.com/dim) | <sup>3</sup> L70/B50 at Tc max. 75 °C | <sup>4</sup> Recommended retail price excl. VAT

### STRIP ACCESSORIES

Extract from the system components of the extensive LED Strip accessories

► Details see chapter STRIP ACCESSORIES

#### CONNECTORS



LS AY PFM-CP/P2/500  
4058075272200



LS AY PFM-CSD/P2  
4058075275393

#### ENDCAPS

#### MOUNTING BRACKETS



LS AY PFM-8/SMB  
4058075275645

### PROFILES

Matching profiles (orange) with corresponding covers and installation accessories

► Details see chapter PROFILES

LS AY SUP-PF01/U/16X10/13/1 4058075304741	LS AY SUP-PFS01/16X10/13/0,015 4058075304710	LS AY-PW01/U/26X8/14/1 4058075278103	LS AY-PW02/UW/39X26/14/1 4058075278134	LS AY-PW03/U/26X26/14/1 4058075278165	LS AY-PF01/UW/22X6/10/1 4058075278196	LS AY-PF02/U/16X5/10/1 4058075278226	LS AY-PF03/UW/25X7/12/1 4058075278257
LS AY-PF04/U/17X7/12/1 4058075278288	LS AY-PM01/UW/21,5X12/10/1 4058075278318	LS AY-PM04/UW/23X15,5/10/1 4058075278400	LS AY-PM05/U/17,5X14,5/10/1 4058075279278	LS AY-PM02/RV/18X15,5/10/1 4058075278349	LS AY-PM03/E/19X19/10/1 4058075278370	LS AY-PM06/E/18X18/12/1 4058075279308	

### DRIVERS

Extract from the versatile driver portfolio

► Details see chapter DRIVERS

DR DALI-SUP-150/220-240/24 4058075421868	DR DIM-PFM-100/220-240/24/P 4058075240070	DR VAL-120/220-240/24 4058075240131

## LED STRIP PERFORMANCE-1500 PROTECTED

High performance IP66 protected LED strips with 1500 lm/m for high requirements



Prewired cables on both sides

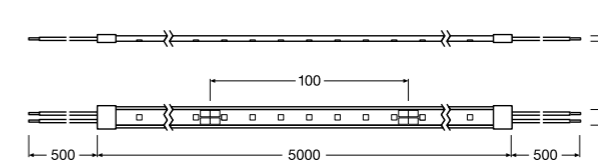

IP66  
 CRI >80  
 3 year guarantee  
 SDCM ≤4  
 DIM



E-number	Product name	GTIN (EAN)	COLOR	K	Im	Im	W	W	Im/W	V <sub>DC</sub>
	LS PFM-1500/827/5/IP66	4058075236301	Warm white	2700	1280	6400	11.6	58.0	110.3	24
	LS PFM-1500/830/5/IP66	4058075236325	White	3000	1300	6500	11.6	58.0	112.1	24
	LS PFM-1500/840/5/IP66	4058075236349	Cool white	4000	1400	7000	11.6	58.0	120.7	24
	LS PFM-1500/865/5/IP66	4058075236363	Daylight	6500	1400	7000	11.6	58.0	120.7	24

Product name	PITCH [mm]	α	IP	t <sub>inj</sub>	T <sub>a</sub>	L x W x H [mm]	CABLE LENGTH	Imax [mA]	PRICE [EUR]	PRICE METER [EUR]
LS PFM-1500/827/5/IP66	70	14.30	105	A+	35000	-15...+45	5000x10.0x4.5	500	100.0	
LS PFM-1500/830/5/IP66	70	14.30	105	A+	35000	-15...+45	5000x10.0x4.5	500	100.0	
LS PFM-1500/840/5/IP66	70	14.30	105	A+	35000	-15...+45	5000x10.0x4.5	500	100.0	
LS PFM-1500/865/5/IP66	70	14.30	105	A+	35000	-15...+45	5000x10.0x4.5	500	100.0	

<sup>1</sup> Refer to [www.ledvance.com/guarantee](http://www.ledvance.com/guarantee) for precise conditions | <sup>2</sup> Dimmable with suitable drivers, see also [www.ledvance.com/dim](http://www.ledvance.com/dim) | <sup>3</sup> L70/B50 at Tc max. 75 °C | <sup>4</sup> Recommended retail price excl. VAT

### STRIP ACCESSORIES

Extract from the system components of the extensive LED Strip accessories

► Details see chapter STRIP ACCESSORIES

#### CONNECTORS



LS AY PFM-CP/P2/500/P  
4058075272958



LS AY PFM-CSD/P2/P  
4058075275485

#### ENDCAPS



LS AY PFM-10/SE/P SIL-SEAL  
4058075275744

#### MOUNTING BRACKETS



LS AY PFM-10/SMB  
4058075275676

### PROFILES

Matching profiles (orange) with corresponding covers and installation accessories

► Details see chapter PROFILES

LS AY SUP-PF01/U/16X10/13/1 4058075304741	LS AY SUP-PFS01/16X10/13/0,015 4058075304710	LS AY-PW01/U/26X8/14/1 4058075278103	LS AY-PW02/UW/39X26/14/1 4058075278134	LS AY-PW03/U/26X26/14/1 4058075278165	LS AY-PF01/UW/22X6/10/1 4058075278196	LS AY-PF02/U/16X5/10/1 4058075278226	LS AY-PF03/UW/25X7/12/1 4058075278257
LS AY-PF04/U/17X7/12/1 4058075278288	LS AY-PM01/UW/21,5X12/10/1 4058075278318	LS AY-PM04/UW/23X15,5/10/1 4058075278400	LS AY-PM05/U/17,5X14,5/10/1 4058075279278	LS AY-PM02/RV/18X15,5/10/1 4058075278349	LS AY-PM03/E/19X19/10/1 4058075278370	LS AY-PM06/E/18X18/12/1 4058075279308	

### DRIVERS

Extract from the versatile driver portfolio

► Details see chapter DRIVERS

DR DIM-PFM-100/220-240/24 4058075240070	DR PFM-100/220-240/24/P 4058075239937	DR VAL-120/220-240/24 4058075240131

## LED STRIP PERFORMANCE-2000

High performance LED strips with 2000 lm/m for high requirements



Prewired cables on both sides

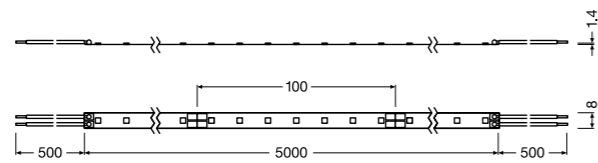

IP00  
 CRI >80  
 SDCM ≤4  
 DIM  
 3 year guarantee  
 LEDVANCE



E-number	Product name	GTIN (EAN)	COLOR	K	Im	Im	W	W	lm/W	V <sub>DC</sub>
LS PFM-2000/827/5		4058075236127	Warm white	2700	1800	9000	14.4	72.0	125.0	24
LS PFM-2000/830/5		4058075236165	White	3000	1850	9250	14.4	72.0	128.5	24
LS PFM-2000/840/5		4058075236189	Cool white	4000	2000	10000	14.4	72.0	138.9	24
LS PFM-2000/865/5		4058075236202	Daylight	6500	2000	10000	14.4	72.0	138.9	24

Product name	PITCH [mm]	∠	IP	t <sub>inj</sub>	T <sub>a</sub>	L x W x H [mm]	CABLE LENGTH	Imax [mA]	PRICE [EUR]	PRICE METER [EUR]
LS PFM-2000/827/5	70	14.30	120	A+	35000	-15...+45	5000x8.0x1.4	500	100.0	
LS PFM-2000/830/5	70	14.30	120	A+	35000	-15...+45	5000x8.0x1.4	500	100.0	
LS PFM-2000/840/5	70	14.30	120	A+	35000	-15...+45	5000x8.0x1.4	500	100.0	
LS PFM-2000/865/5	70	14.30	120	A+	35000	-15...+45	5000x8.0x1.4	500	100.0	

<sup>1</sup> Refer to www.ledvance.com/guarantee for precise conditions | <sup>2</sup> Dimmable with suitable drivers, see also www.ledvance.com/dim | <sup>3</sup> L70/B50 at Tc max. 75 °C | <sup>4</sup> Recommended retail price excl. VAT

### STRIP ACCESSORIES

Extract from the system components of the extensive LED Strip accessories

► Details see chapter STRIP ACCESSORIES

#### CONNECTORS



LS AY PFM-CP/P2/500  
4058075272200



LS AY PFM-CSD/P2  
4058075275393

#### ENDCAPS

#### MOUNTING BRACKETS



LS AY PFM-8/SMB  
4058075275645

### PROFILES

Matching profiles (orange) with corresponding covers and installation accessories

► Details see chapter PROFILES

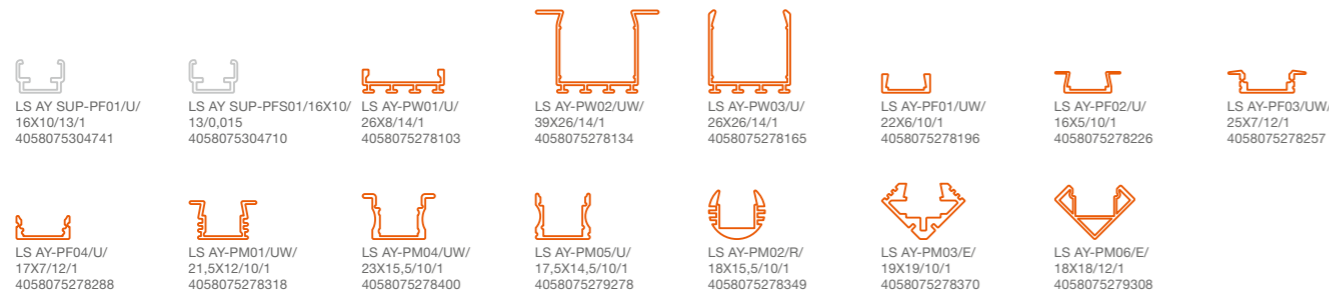

### DRIVERS

Extract from the versatile driver portfolio

► Details see chapter DRIVERS



## LED STRIP PERFORMANCE-2000 PROTECTED

High performance IP66 protected LED strips with 2000 lm/m for high requirements



Prewired cables on both sides

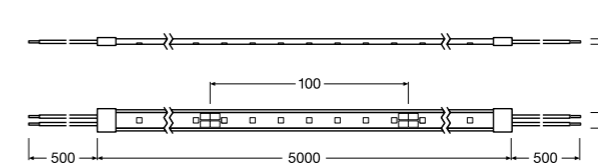

IP66  
 CRI >80  
 SDCM ≤4  
 DIM  
 3 year guarantee  
 LEDVANCE



E-number	Product name	GTIN (EAN)	COLOR	K	Im	Im	W	W	lm/W	V <sub>DC</sub>
LS PFM-2000/827/5/IP66		4058075236462	Warm white	2700	1700	8500	14.4	72.0	118.1	24
LS PFM-2000/830/5/IP66		4058075236509	White	3000	1750	8750	14.4	72.0	121.5	24
LS PFM-2000/840/5/IP66		4058075236561	Cool white	4000	1900	9500	14.4	72.0	131.9	24
LS PFM-2000/865/5/IP66		4058075236608	Daylight	6500	1900	9500	14.4	72.0	131.9	24

Product name	PITCH [mm]	∠	IP	t <sub>inj</sub>	T <sub>a</sub>	L x W x H [mm]	CABLE LENGTH	Imax [mA]	PRICE [EUR]	PRICE METER [EUR]
LS PFM-2000/827/5/IP66	70	14.30	105	A+	35000	-15...+45	5000x10.0x4.5	500	100.0	
LS PFM-2000/830/5/IP66	70	14.30	105	A+	35000	-15...+45	5000x10.0x4.5	500	100.0	
LS PFM-2000/840/5/IP66	70	14.30	105	A+	35000	-15...+45	5000x10.0x4.5	500	100.0	
LS PFM-2000/865/5/IP66	70	14.30	105	A+	35000	-15...+45	5000x10.0x4.5	500	100.0	

<sup>1</sup> Refer to www.ledvance.com/guarantee for precise conditions | <sup>2</sup> Dimmable with suitable drivers, see also www.ledvance.com/dim | <sup>3</sup> L70/B50 at Tc max. 75 °C | <sup>4</sup> Recommended retail price excl. VAT

### STRIP ACCESSORIES

Extract from the system components of the extensive LED Strip accessories

► Details see chapter STRIP ACCESSORIES

#### CONNECTORS



LS AY PFM-CP/P2/500/P  
4058075272958



LS AY PFM-CSD/P2/P  
4058075275485

#### ENDCAPS



LS AY PFM-10/SE/P SIL-SEAL  
4058075275744

#### MOUNTING BRACKETS



LS AY PFM-10/SMB  
4058075275676

### PROFILES

Matching profiles (orange) with corresponding covers and installation accessories

► Details see chapter PROFILES

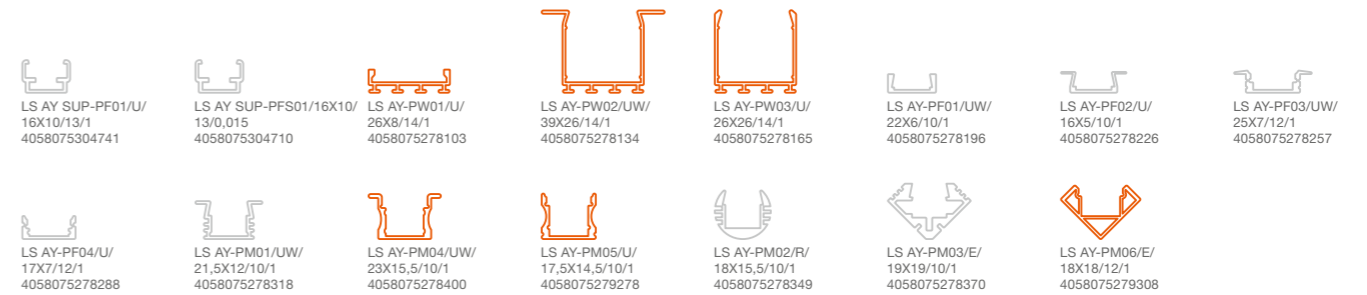

### DRIVERS

Extract from the versatile driver portfolio

► Details see chapter DRIVERS



# A MIX OF WHITE AND COLOR LED STRIPS PERFORMANCE CLASS RGBW

PERFORMANCE CLASS

RGBW

LEDVANCE RGBW LED Strips are the perfect solution for all applications where you need a defined white light color in addition to RGB lighting. If you equip an application area with only one RGBW LED Strip, either a wide range of colors or a naturally white light can be controlled, depending on the requirements. RGBW LED Strips are available in four different white tones (2,700, 3,000, 4,000 and 6,500 kelvin) and also with IP66 rating for outdoor use.

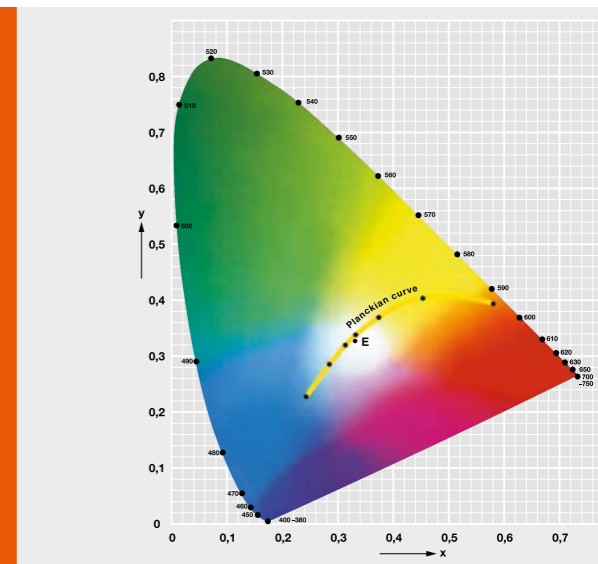

- A life of up to 40,000 hours<sup>1</sup>
- Color rendering index CRI ≥ 80
- Color consistency SDCM ≤ 4
- Luminous flux of 1,000 lm/m – tailored for ambient, cove and general lighting
- 4 white color temperatures: 2,700 K, 3,000 K, 4,000 K, 6,500 K
- Type of protection IP 00/66
- Salt mist resistant (to IEC 60068-2-52) and UV resistant (to IEC 60068-2-5) at IP66
- TÜV approval
- 3-year guarantee<sup>2</sup>

### LIGHT WITH ADDED VALUE

Whether it's white light or colored light – with RGBW LED Strips users can easily adapt the lighting to their needs. Not only do they allow for central elements in the room to be bathed in eye-catching light but also for signal effects to be generated.

<sup>1</sup> L70/B50 at T<sub>c</sub> max. 85 °C | <sup>2</sup> For precise terms and conditions go to [www.ledvance.com/guarantee](http://www.ledvance.com/guarantee)

### EXCITING ACCENTS

Through indirect lighting of simple objects, you can create an atmospheric ambience in rooms with RGBW LED Strips. The lighting effects can easily be adjusted to suit your needs here too – from cold-white work mode to colorful party mood.

### HUGE COLOR SPECTRUM

In additive color mixing, red, green and blue (RGB) can reproduce a large color spectrum. Adding the white LED (RGBW) also enables pastel tones, which significantly extends the color space.

### CONNECTION DIAGRAM FOR RGBW LED STRIP

**Important!**  
In combination with the multi-channel controller and the RGBW control elements, 24V DC LED drivers ensure correct and easy handling of multi-color/tunable white operation.

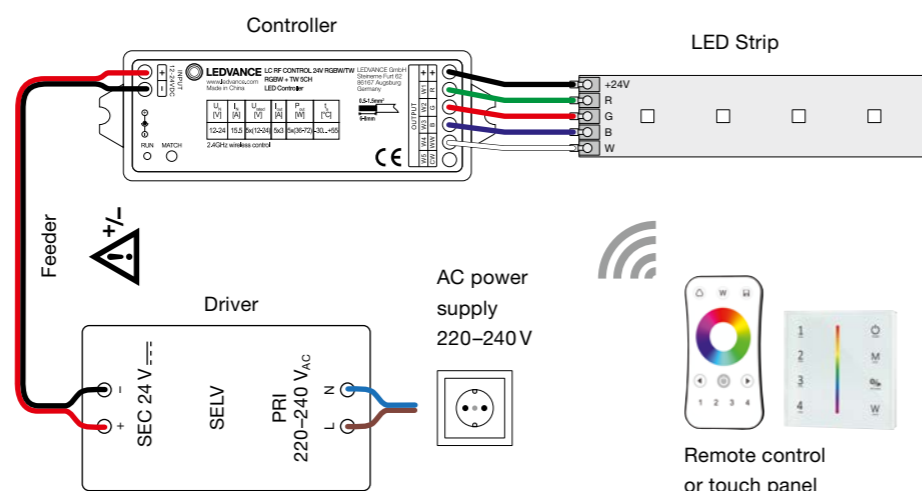

### CHECK: THIS IS HOW YOUR RGBW LED STRIP SYSTEM WORKS



The RGBW versions of the LEDVANCE LED Strips can be installed to suit individual planning. However, the following components are essential for a functioning RGBW system.

#### System components for LEDVANCE RGBW LED STRIP:

- Multichannel controller RGBW/TW: LC RF Controller 24V RGBW/TW
- Control elements RGBW: remote control (LC RF REMOTE RGBW) and/or touch panel (LC RF TOUCH PANEL RGBW)

Alternatively, you can use a DALI or DMX system.

### PRODUCT BENEFITS

- Great design freedom thanks to long, flexible RGBW LED Strips
- Easy installation and tool-free connection
- Easy mounting on many smooth surfaces with self-adhesive tape
- Protected LED Strips suitable for use in damp environments thanks to high degree of protection (IP66)
- Maximum flexibility thanks to a wide range of accessories
- Simple connection thanks to integrated cables on both sides
- Intensive color effects for special moods
- Good white light thanks to the additional white LEDs

### APPLICATIONS

- General indoor lighting
- Protected LED Strips for general outdoor lighting (IP66)
- Dynamic effects in public zones
- Hotels, architectural lighting and homes
- Offices, sales and conference rooms
- Decorative cove lighting

# LED STRIP PERFORMANCE-1000 RGBW

High performance RGBW LED strips with 1000 lm/m for high requirements



Prewired cables on both sides

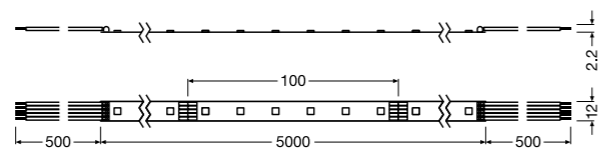

E-number	Product name	GTIN (EAN)	COLOR	K	Im	Im	W	W	lm/W	V <sub>DC</sub>
LS PFM-1000/RGBW/827/5		4058075436145	RGB, white	2700	369 / R 100 / G 277 / B 61 / W 955	6190	19.4	97.0	69.0	24
LS PFM-1000/RGBW/830/5		4058075436206	RGB, white	3000	367 / R 100 / G 277 / B 61 / W 1005	6420	19.4	97.0	71.0	24
LS PFM-1000/RGBW/840/5		4058075436282	RGB, white	4000	364 / R 100 / G 277 / B 61 / W 1056	6655	19.4	97.0	74.0	24
LS PFM-1000/RGBW/865/5		4058075436312	RGB, white	6500	364 / R 100 / G 277 / B 61 / W 1056	6655	19.4	97.0	74.0	24

Product name	PITCH [mm]	W	H	t [mm]	T <sub>a</sub>	L x W x H [mm]	CABLE LENGTH	Im	PRICE (EUR)	PRICE (EUR)
LS PFM-1000/RGBW/827/5	120	16.67	120	A	40000	-20...+55	5000 x 12.0 x 2.2	500	100.0	
LS PFM-1000/RGBW/830/5	120	16.67	120	A	40000	-20...+55	5000 x 12.0 x 2.2	500	100.0	
LS PFM-1000/RGBW/840/5	120	16.67	120	A	40000	-20...+55	5000 x 12.0 x 2.2	500	100.0	
LS PFM-1000/RGBW/865/5	120	16.67	120	A	40000	-20...+55	5000 x 12.0 x 2.2	500	100.0	

<sup>1</sup> Refer to www.ledvance.com/guarantee for precise conditions | <sup>2</sup> Dimmable with suitable drivers, see also www.ledvance.com/dim | <sup>3</sup> L70/B50 at Tc max. 85 °C | <sup>4</sup> Recommended retail price excl. VAT

## STRIP ACCESSORIES

Extract from the system components of the extensive LED Strip accessories

► Details see chapter STRIP ACCESSORIES

### CONNECTORS



### ENDCAPS

### MOUNTING BRACKETS



## PROFILES

Matching profiles (orange) with corresponding covers and installation accessories

► Details see chapter PROFILES

 LS AY SUP-PF01/U/16X10/13/1 4058075304741	 LS AY SUP-PFS01/16X10/13/0,015 4058075304710	 LS AY-PW01/U/26X8/14/1 4058075278103	 LS AY-PW02/U/39X26/14/1 4058075278134	 LS AY-PW03/U/26X26/14/1 4058075278165	 LS AY-PF01/UW/22X6/10/1 4058075278196	 LS AY-PF02/U/16X5/10/1 4058075278226	 LS AY-PF03/UW/25X7/12/1 4058075278257
 LS AY-PF04/U/17X7/12/1 4058075278288	 LS AY-PM01/UW/21,5X12/10/1 4058075278318	 LS AY-PM04/UW/23X15,5/10/1 4058075278400	 LS AY-PM05/U/17,5X14,5/10/1 4058075279278	 LS AY-PM02/RV/18X15,5/10/1 4058075278349	 LS AY-PM03/E/19X19/10/1 4058075278370	 LS AY-PM06/E/18X18/12/1 4058075279308	

## DRIVERS

Extract from the versatile driver portfolio

► Details see chapter DRIVERS

 DR-VAL-120/220-240/24 4058075240131	 LC RF CONTROL 24V RGBW/TW 4058075435834	 LC RF TOUCH PANEL RGBW 4058075435896	 LC RF REMOTE RGBW 4058075435858
--	--	---	--

# LED STRIP PERFORMANCE-1000 RGBW PROTECTED

High performance IP66 protected RGBW LED strips with 1000 lm/m for high requirements



Prewired cables on both sides

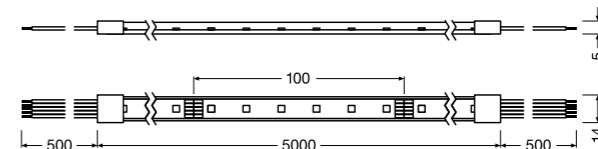

E-number	Product name	GTIN (EAN)	COLOR	K	Im	Im	W	W	lm/W	V <sub>DC</sub>
LS PFM-1000/RGBW/827/5/IP66		4058075436053	RGB, white	2700	246 / R 86 / G 230 / B 54 / W 912	6514	19.4	97.0	60.0	24
LS PFM-1000/RGBW/830/5/IP66		4058075436114	RGB, white	3000	241 / R 86 / G 230 / B 54 / W 960	6748	19.4	97.0	62.0	24
LS PFM-1000/RGBW/840/5/IP66		4058075436176	RGB, white	4000	236 / R 86 / G 230 / B 54 / W 1008	6982	19.4	97.0	64.0	24
LS PFM-1000/RGBW/865/5/IP66		4058075436237	RGB, white	6500	236 / R 86 / G 230 / B 54 / W 1008	6982	19.4	97.0	64.0	24

Product name	PITCH [mm]	W	H	t [mm]	T <sub>a</sub>	L x W x H [mm]	CABLE LENGTH	Im	PRICE (EUR)	PRICE (EUR)
LS PFM-1000/RGBW/827/5/IP66	120	16.67	120	A	40000	-20...+55	5000 x 14.0 x 5.0	500	100.0	
LS PFM-1000/RGBW/830/5/IP66	120	16.67	120	A	40000	-20...+55	5000 x 14.0 x 5.0	500	100.0	
LS PFM-1000/RGBW/840/5/IP66	120	16.67	120	A	40000	-20...+55	5000 x 14.0 x 5.0	500	100.0	
LS PFM-1000/RGBW/865/5/IP66	120	16.67	120	A	40000	-20...+55	5000 x 14.0 x 5.0	500	100.0	

<sup>1</sup> Refer to www.ledvance.com/guarantee for precise conditions | <sup>2</sup> Dimmable with suitable drivers, see also www.ledvance.com/dim | <sup>3</sup> L70/B50 at Tc max. 85 °C | <sup>4</sup> Recommended retail price excl. VAT

## STRIP ACCESSORIES

Extract from the system components of the extensive LED Strip accessories

► Details see chapter STRIP ACCESSORIES

### CONNECTORS



### ENDCAPS



### MOUNTING BRACKETS



## PROFILES

Matching profiles (orange) with corresponding covers and installation accessories

► Details see chapter PROFILES

 LS AY SUP-PF01/U/16X10/13/1 4058075304741	 LS AY SUP-PFS01/16X10/13/0,015 4058075304710	 LS AY-PW01/U/26X8/14/1 4058075278103	 LS AY-PW02/U/39X26/14/1 4058075278134	 LS AY-PW03/U/26X26/14/1 4058075278165	 LS AY-PF01/UW/22X6/10/1 4058075278196	 LS AY-PF02/U/16X5/10/1 4058075278226	 LS AY-PF03/UW/25X7/12/1 4058075278257
 LS AY-PF04/U/17X7/12/1 4058075278288	 LS AY-PM01/UW/21,5X12/10/1 4058075278318	 LS AY-PM04/UW/23X15,5/10/1 4058075278400	 LS AY-PM05/U/17,5X14,5/10/1 4058075279278	 LS AY-PM02/RV/18X15,5/10/1 4058075278349	 LS AY-PM03/E/19X19/10/1 4058075278370	 LS AY-PM06/E/18X18/12/1 4058075279308	

## DRIVERS

Extract from the versatile driver portfolio

► Details see chapter DRIVERS

 DR-PFM-150/220-240/24/P 4058075239975	 LC RF CONTROL 24V RGBW/TW 4058075435834	 LC RF TOUCH PANEL RGBW 4058075435896	 LC RF REMOTE RGBW 4058075435858
--	--	---	--



# GOOD LIGHT AT A GOOD PRICE

## THE VALUE CLASS RANGE AT A GLANCE

VALUE CLASS

WHITE

As a lighting professional you regularly get jobs where purchase costs are a deciding factor. You can now sell good light to these customers with a clear conscience. Even though the products in the LEDVANCE LED Strip Value Class cost less than those in the higher segments they have plenty to offer. Their quality of light, durability and flexibility are perfectly suited to small commercial or residential applications. The choice of color temperatures, luminous fluxes and IP ratings covers virtually all indoor and outdoor applications.



- A life of up to 20,000 hours<sup>1</sup>
- Color rendering index CRI ≥ 80
- Luminous fluxes from 300 to 1,400 lm/m – tailored for ambient, cove and general lighting
- 4 color temperatures: 2,700 K, 3,000 K, 4,000 K, 6,500 K
- Type of protection IP 00/65
- UV resistance (to IEC 60068-2-5) at IP65

### AMBIENT LIGHTING

The LEDVANCE Value Class proves that good light does not have to be expensive. Stylish and efficient ambient lighting on stairs is easily achieved at an excellent price/performance ratio with pleasant warm white LED Strips. LEDVANCE LED Strips Value Class with **3,000 K, 300 lm/m and IP00** are ideal for the subtle but effective illumination of staircases. Protected by a profile and with a diffuse cover they guide the way beautifully.

### COVE LIGHTING

For kitchens, home bars or corner units in bed & breakfast establishments under-cabinet lighting with LEDVANCE LED Strips Value Class in the neutral color temperature of 4,000 K creates optimum illumination and sufficient light to work. LEDVANCE LED Strips Value Class with **4,000 K, 1,000 lm/m and IP65** can be installed near water thanks to their high IP rating. Strips can also be installed on the under-edges of counter tops to create a welcoming atmosphere.

### GENERAL LIGHTING

The Value Class includes LED Strips with high luminous fluxes and daylight white 6,500 K. So you can use them in small commercial and residential areas as a cost-effective way of highlighting architectural features and creating efficient and innovative general lighting. With LEDVANCE LED Strips Value Class with **6,500 K, 1,400 lm/m and IP00** and the right profiles and covers you are ideally equipped to create perfect lighting in large rooms.

<sup>1</sup> L70/B50 at T<sub>c</sub> max: 65 °C



### PRODUCT BENEFITS

- Great design freedom thanks to long, flexible LED Strips
- Easy mounting on many smooth surfaces with self-adhesive tape
- Protected LED Strips suitable for use in damp environments thanks to high degree of protection (IP65)
- Maximum flexibility thanks to a wide range of accessories
- Simple connection thanks to integrated cables on both sides

### APPLICATIONS

- General indoor lighting
- Protected LED Strips for general outdoor lighting (IP65)
- Decorative lighting
- Private homes

## LED STRIP VALUE-300

LED strips with 300 lm/m for general application



Prewired cables on both sides

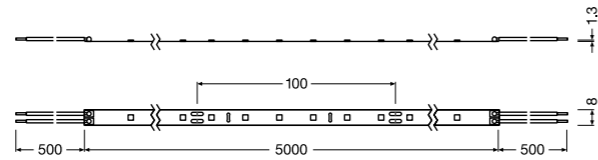

IP00 CRI >80 DIM



E-number	Product name	GTIN (EAN)	COLOR	K	lm <sup>2</sup> METER	lm	W <sup>2</sup> METER	W	lm/W <sup>2</sup>	V <sub>DC</sub>
LS VAL-300/827/5		4058075296060	Warm white	2700	300	1262	3.0	14.5	100.0	24
LS VAL-300/830/5		4058075296091	White	3000	310	1307	3.0	14.5	103.0	24
LS VAL-300/840/5		4058075296121	Cool white	4000	330	1307	3.0	14.5	110.0	24
LS VAL-300/865/5		4058075296152	Daylight	6500	330	1307	3.0	14.5	110.0	24

Product name	PITCH [mm]	°	IP	t <sub>inj</sub>	T <sub>a</sub>	L x W x H [mm]	CABLE LENGTH	Imax [mA]	PRICE (EUR)	PRICE METER (EUR)
LS VAL-300/827/5	60	16.67	120	A+	20000	-20...+40	5000x8.0x1.3	500	100.0	
LS VAL-300/830/5	60	16.67	120	A+	20000	-20...+40	5000x8.0x1.3	500	100.0	
LS VAL-300/840/5	60	16.67	120	A+	20000	-20...+40	5000x8.0x1.3	500	100.0	
LS VAL-300/865/5	60	16.67	120	A+	20000	-20...+40	5000x8.0x1.3	500	100.0	

<sup>1</sup> Dimmable with suitable drivers, see also www.ledvance.com/dim | <sup>2</sup> Value based on first meter of the product | <sup>3</sup> L70/B50 at Tc max. 65°C | <sup>4</sup> Recommended retail price excl. VAT

### STRIP ACCESSORIES

Extract from the system components of the extensive LED Strip accessories

► Details see chapter STRIP ACCESSORIES

CONNECTORS

ENDCAPS

MOUNTING BRACKETS

### PROFILES

Matching profiles (orange) with corresponding covers and installation accessories

► Details see chapter PROFILES

LS AY SUP-PF01/U/16X10/13/1 4058075304741

LS AY SUP-PFS01/16X10/13/0,015 4058075304710

LS AY-PW01/U/26X8/14/1 4058075278103

LS AY-PW02/UW/39X26/14/1 4058075278134

LS AY-PW03/U/26X26/14/1 4058075278165

LS AY-PF01/UW/22X6/10/1 4058075278196

LS AY-PF02/U/16X5/10/1 4058075278226

LS AY-PF03/UW/25X7/12/1 4058075278257

LS AY-PF04/U/17X7/12/1 4058075278288

LS AY-PM01/UW/21,5X12/10/1 4058075278318

LS AY-PM04/UW/23X15,5/10/1 4058075278400

LS AY-PM05/U/17,5X14,5/10/1 4058075279278

LS AY-PM02/R/18X15,5/10/1 4058075278349

LS AY-PM03/E/19X19/10/1 4058075278370

LS AY-PM06/E/18X18/12/1 4058075279308

### DRIVERS

Extract from the versatile driver portfolio

► Details see chapter DRIVERS

DR DIM-PFM-40/220-240/24/P 4058075379176

DR-PFM-30/220-240/24/P 4058075239890

DR-VAL-30/220-240/24/P 4058075240056

## LED STRIP VALUE-300 PROTECTED

IP65 protected LED strips with 300 lm/m for general applications



Prewired cables on both sides

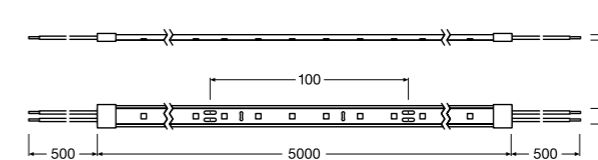

IP65 CRI >80 DIM



E-number	Product name	GTIN (EAN)	COLOR	K	lm <sup>2</sup> METER	lm	W <sup>2</sup> METER	W	lm/W <sup>2</sup>	V <sub>DC</sub>
LS VAL-300/827/5/IP65		4058075296183	Warm white	2700	285	1200	3.0	14.5	95.0	24
LS VAL-300/830/5/IP65		4058075296213	White	3000	295	1244	3.0	14.5	98.0	24
LS VAL-300/840/5/IP65		4058075296244	Cool white	4000	310	1315	3.0	14.5	103.0	24
LS VAL-300/865/5/IP65		4058075296275	Daylight	6500	310	1315	3.0	14.5	103.0	24

Product name	PITCH [mm]	°	IP	t <sub>inj</sub>	T <sub>a</sub>	L x W x H [mm]	CABLE LENGTH	Imax [mA]	PRICE (EUR)	PRICE METER (EUR)
LS VAL-300/827/5/IP65	60	16.67	105	A+	20000	-20...+40	5000x10.0x4.1	500	100.0	
LS VAL-300/830/5/IP65	60	16.67	105	A+	20000	-20...+40	5000x10.0x4.1	500	100.0	
LS VAL-300/840/5/IP65	60	16.67	105	A+	20000	-20...+40	5000x10.0x4.1	500	100.0	
LS VAL-300/865/5/IP65	60	16.67	105	A+	20000	-20...+40	5000x10.0x4.1	500	100.0	

<sup>1</sup> Dimmable with suitable drivers, see also www.ledvance.com/dim | <sup>2</sup> Value based on first meter of the product | <sup>3</sup> L70/B50 at Tc max. 65°C | <sup>4</sup> Recommended retail price excl. VAT

### STRIP ACCESSORIES

Extract from the system components of the extensive LED Strip accessories

► Details see chapter STRIP ACCESSORIES

CONNECTORS

ENDCAPS

MOUNTING BRACKETS



### PROFILES

Matching profiles (orange) with corresponding covers and installation accessories

► Details see chapter PROFILES

LS AY SUP-PF01/U/16X10/13/1 4058075304741

LS AY SUP-PFS01/16X10/13/0,015 4058075304710

LS AY-PW01/U/26X8/14/1 4058075278103

LS AY-PW02/UW/39X26/14/1 4058075278134

LS AY-PW03/U/26X26/14/1 4058075278165

LS AY-PF01/UW/22X6/10/1 4058075278196

LS AY-PF02/U/16X5/10/1 4058075278226

LS AY-PF03/UW/25X7/12/1 4058075278257

LS AY-PF04/U/17X7/12/1 4058075278288

LS AY-PM01/UW/21,5X12/10/1 4058075278318

LS AY-PM04/UW/23X15,5/10/1 4058075278400

LS AY-PM05/U/17,5X14,5/10/1 4058075279278

LS AY-PM02/R/18X15,5/10/1 4058075278349

LS AY-PM03/E/19X19/10/1 4058075278370

LS AY-PM06/E/18X18/12/1 4058075279308

### DRIVERS

Extract from the versatile driver portfolio

► Details see chapter DRIVERS

DR DIM-PFM-40/220-240/24/P 4058075379176

DR-PFM-30/220-240/24/P 4058075239890

DR-VAL-30/220-240/24/P 4058075240056

## LED STRIP VALUE-600

LED strips with 600 lm/m for general applications



Prewired cables on both sides

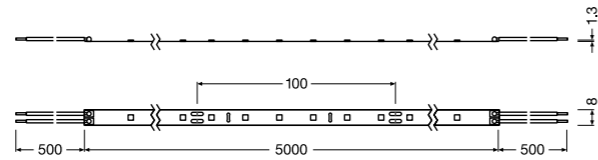

IP00 CRI >80 DIM



E-number	Product name	GTIN (EAN)	COLOR	K	lm <sup>2</sup> METER	lm	W <sup>2</sup> METER	W	lm/W <sup>2</sup>	V <sub>DC</sub>
LS VAL-600/827/5		4058075296664	Warm white	2700	540	2276	5.5	27.0	98.0	24
LS VAL-600/830/5		4058075296787	White	3000	550	2311	5.5	27.0	100.0	24
LS VAL-600/840/5		4058075296930	Cool white	4000	570	2533	5.5	27.0	104.0	24
LS VAL-600/865/5		4058075296992	Daylight	6500	580	2533	5.5	27.0	105.0	24

Product name	PITCH [mm]	α	IP	t <sub>inj</sub>	T <sub>a</sub>	L x W x H [mm]	CABLE LENGTH	Imax [mA]	PRICE (EUR)	PRICE (EUR)
LS VAL-600/827/5	60	16.67	120	A+	20000	-20...+40	5000x8.0x1.3	500	100.0	
LS VAL-600/830/5	60	16.67	120	A+	20000	-20...+40	5000x8.0x1.3	500	100.0	
LS VAL-600/840/5	60	16.67	120	A+	20000	-20...+40	5000x8.0x1.3	500	100.0	
LS VAL-600/865/5	60	16.67	120	A+	20000	-20...+40	5000x8.0x1.3	500	100.0	

<sup>1</sup> Dimmable with suitable drivers, see also www.ledvance.com/dim | <sup>2</sup> Value based on first meter of the product | <sup>3</sup> L70/B50 at Tc max. 65°C | <sup>4</sup> Recommended retail price excl. VAT

### STRIP ACCESSORIES

Extract from the system components of the extensive LED Strip accessories

► Details see chapter STRIP ACCESSORIES

CONNECTORS

ENDCAPS

MOUNTING BRACKETS

### PROFILES

Matching profiles (orange) with corresponding covers and installation accessories

► Details see chapter PROFILES

LS AY SUP-PF01/U/ 16X10/13/1 4058075304741

LS AY SUP-PFS01/16X10/ 13/0,015 4058075304710

LS AY-PW01/U/ 26X8/14/1 4058075278103

LS AY-PW02/UW/ 39X26/14/1 4058075278134

LS AY-PW03/U/ 26X26/14/1 4058075278165

LS AY-PF01/UW/ 22X6/10/1 4058075278196

LS AY-PF02/U/ 16X5/10/1 4058075278226

LS AY-PF03/UW/ 25X7/12/1 4058075278257

LS AY-PF04/U/ 17X7/12/1 4058075278288

LS AY-PM01/UW/ 21,5X12/10/1 4058075278318

LS AY-PM04/UW/ 23X15,5/10/1 4058075278400

LS AY-PM05/U/ 17,5X14,5/10/1 4058075279278

LS AY-PM02/R/ 18X15,5/10/1 4058075278349

LS AY-PM03/E/ 19X19/10/1 4058075278370

LS AY-PM06/E/ 18X18/12/1 4058075279308

### DRIVERS

Extract from the versatile driver portfolio

► Details see chapter DRIVERS

DR DIM-PFM-60/220-240/24/P 4058075379190

DR-PFM-60/220-240/24/P 4058075239913

DR-VAL-60/220-240/24/P 4058075240094

## LED STRIP VALUE-600 PROTECTED

IP65 protected LED strips with 600 lm/m for general applications



Prewired cables on both sides

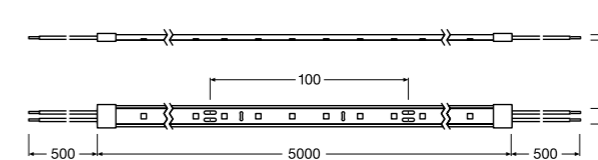

IP65 CRI >80 DIM



E-number	Product name	GTIN (EAN)	COLOR	K	lm <sup>2</sup> METER	lm	W <sup>2</sup> METER	W	lm/W <sup>2</sup>	V <sub>DC</sub>
LS VAL-600/827/5/IP65		4058075296541	Warm white	2700	510	2151	5.5	27.0	93.0	24
LS VAL-600/830/5/IP65		4058075296572	White	3000	520	2196	5.5	27.0	95.0	24
LS VAL-600/840/5/IP65		4058075296602	Cool white	4000	540	2400	5.5	27.0	98.0	24
LS VAL-600/865/5/IP65		4058075296633	Daylight	6500	550	2400	5.5	27.0	100.0	24

Product name	PITCH [mm]	α	IP	t <sub>inj</sub>	T <sub>a</sub>	L x W x H [mm]	CABLE LENGTH	Imax [mA]	PRICE (EUR)	PRICE (EUR)
LS VAL-600/827/5/IP65	60	16.67	105	A+	20000	-20...+40	5000x10.0x4.1	500	100.0	
LS VAL-600/830/5/IP65	60	16.67	105	A+	20000	-20...+40	5000x10.0x4.1	500	100.0	
LS VAL-600/840/5/IP65	60	16.67	105	A+	20000	-20...+40	5000x10.0x4.1	500	100.0	
LS VAL-600/865/5/IP65	60	16.67	105	A+	20000	-20...+40	5000x10.0x4.1	500	100.0	

<sup>1</sup> Dimmable with suitable drivers, see also www.ledvance.com/dim | <sup>2</sup> Value based on first meter of the product | <sup>3</sup> L70/B50 at Tc max. 65°C | <sup>4</sup> Recommended retail price excl. VAT

### STRIP ACCESSORIES

Extract from the system components of the extensive LED Strip accessories

► Details see chapter STRIP ACCESSORIES

CONNECTORS

ENDCAPS

MOUNTING BRACKETS



### PROFILES

Matching profiles (orange) with corresponding covers and installation accessories

► Details see chapter PROFILES

LS AY SUP-PF01/U/ 16X10/13/1 4058075304741

LS AY SUP-PFS01/16X10/ 13/0,015 4058075304710

LS AY-PW01/U/ 26X8/14/1 4058075278103

LS AY-PW02/UW/ 39X26/14/1 4058075278134

LS AY-PW03/U/ 26X26/14/1 4058075278165

LS AY-PF01/UW/ 22X6/10/1 4058075278196

LS AY-PF02/U/ 16X5/10/1 4058075278226

LS AY-PF03/UW/ 25X7/12/1 4058075278257

LS AY-PF04/U/ 17X7/12/1 4058075278288

LS AY-PM01/UW/ 21,5X12/10/1 4058075278318

LS AY-PM04/UW/ 23X15,5/10/1 4058075278400

LS AY-PM05/U/ 17,5X14,5/10/1 4058075279278

LS AY-PM02/R/ 18X15,5/10/1 4058075278349

LS AY-PM03/E/ 19X19/10/1 4058075278370

LS AY-PM06/E/ 18X18/12/1 4058075279308

### DRIVERS

Extract from the versatile driver portfolio

► Details see chapter DRIVERS

DR DIM-PFM-60/220-240/24/P 4058075379190

DR-PFM-60/220-240/24/P 4058075239913

DR-VAL-60/220-240/24/P 4058075240094

## LED STRIP VALUE-1000

LED strips with 1000 lm/m for general applications



Prewired cables on both sides

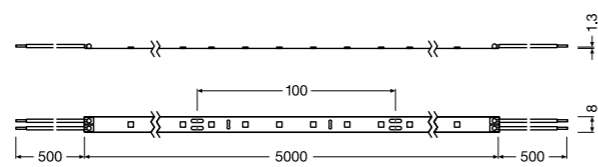

E-number	Product name	GTIN (EAN)	COLOR	K	Im <sup>2</sup> METER	Im	W <sup>2</sup> METER	W	Im/W <sup>2</sup>	V <sub>DC</sub>
LS VAL-1000/827/5		4058075296305	Warm white	2700	980	4027	12.0	55.0	82.0	24
LS VAL-1000/830/5		4058075296336	White	3000	1000	4107	12.0	55.0	83.0	24
LS VAL-1000/840/5		4058075296367	Cool white	4000	1050	4222	12.0	55.0	88.0	24
LS VAL-1000/865/5		4058075296398	Daylight	6500	1050	4222	12.0	55.0	88.0	24

Product name	PITCH [mm]	∠	IP	t <sub>inj</sub>	T <sub>a</sub>	L x W x H [mm]	CABLE LENGTH	Imax [mA]	PRICE (EUR)	PRICE (EUR)
LS VAL-1000/827/5	60	16.67	120	A	20000	-20...+40	5000x8.0x1.3	500	100.0	
LS VAL-1000/830/5	60	16.67	120	A	20000	-20...+40	5000x8.0x1.3	500	100.0	
LS VAL-1000/840/5	60	16.67	120	A	20000	-20...+40	5000x8.0x1.3	500	100.0	
LS VAL-1000/865/5	60	16.67	120	A	20000	-20...+40	5000x8.0x1.3	500	100.0	

<sup>1</sup> Dimmable with suitable drivers, see also www.ledvance.com/dim | <sup>2</sup> Value based on first meter of the product | <sup>3</sup> L70/B50 at Tc max. 65°C | <sup>4</sup> Recommended retail price excl. VAT

### STRIP ACCESSORIES

Extract from the system components of the extensive LED Strip accessories

► Details see chapter STRIP ACCESSORIES

CONNECTORS

ENDCAPS

MOUNTING BRACKETS

### PROFILES

Matching profiles (orange) with corresponding covers and installation accessories

► Details see chapter PROFILES

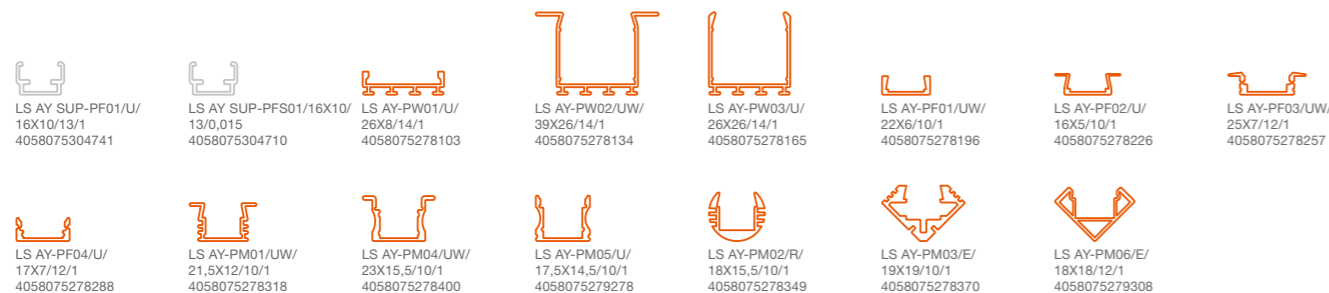

### DRIVERS

Extract from the versatile driver portfolio

► Details see chapter DRIVERS



DR DIM-PFM-60/220-240/24/P  
4058075379190

DR-PFM-60/220-240/24/P  
4058075239913

DR-VAL-60/220-240/24/P  
4058075240094

## LED STRIP VALUE-1000 PROTECTED

IP65 protected LED strips with 1000 lm/m for general applications



Prewired cables on both sides

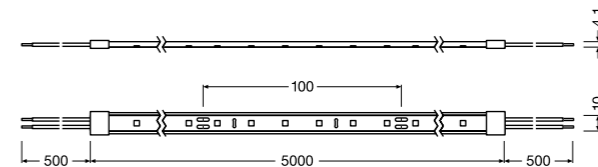

E-number	Product name	GTIN (EAN)	COLOR	K	Im <sup>2</sup> METER	Im	W <sup>2</sup> METER	W	Im/W <sup>2</sup>	V <sub>DC</sub>
LS VAL-1000/827/5/IP65		4058075296428	Warm white	2700	930	3822	12.0	55.0	78.0	24
LS VAL-1000/830/5/IP65		4058075296459	White	3000	950	3973	12.0	55.0	79.0	24
LS VAL-1000/840/5/IP65		4058075296480	Cool white	4000	990	4062	12.0	55.0	83.0	24
LS VAL-1000/865/5/IP65		4058075296510	Daylight	6500	990	4062	12.0	55.0	83.0	24

Product name	PITCH [mm]	∠	IP	t <sub>inj</sub>	T <sub>a</sub>	L x W x H [mm]	CABLE LENGTH	Imax [mA]	PRICE (EUR)	PRICE (EUR)
LS VAL-1000/827/5/IP65	60	16.67	105	A	20000	-20...+40	5000x10.0x4.1	500	100.0	
LS VAL-1000/830/5/IP65	60	16.67	105	A	20000	-20...+40	5000x10.0x4.1	500	100.0	
LS VAL-1000/840/5/IP65	60	16.67	105	A	20000	-20...+40	5000x10.0x4.1	500	100.0	
LS VAL-1000/865/5/IP65	60	16.67	105	A	20000	-20...+40	5000x10.0x4.1	500	100.0	

<sup>1</sup> Dimmable with suitable drivers, see also www.ledvance.com/dim | <sup>2</sup> Value based on first meter of the product | <sup>3</sup> L70/B50 at Tc max. 65°C | <sup>4</sup> Recommended retail price excl. VAT

### STRIP ACCESSORIES

Extract from the system components of the extensive LED Strip accessories

► Details see chapter STRIP ACCESSORIES

CONNECTORS

ENDCAPS

MOUNTING BRACKETS



LS AY PFM-10/SE/P SIL-SEAL  
4058075275744

### PROFILES

Matching profiles (orange) with corresponding covers and installation accessories

► Details see chapter PROFILES

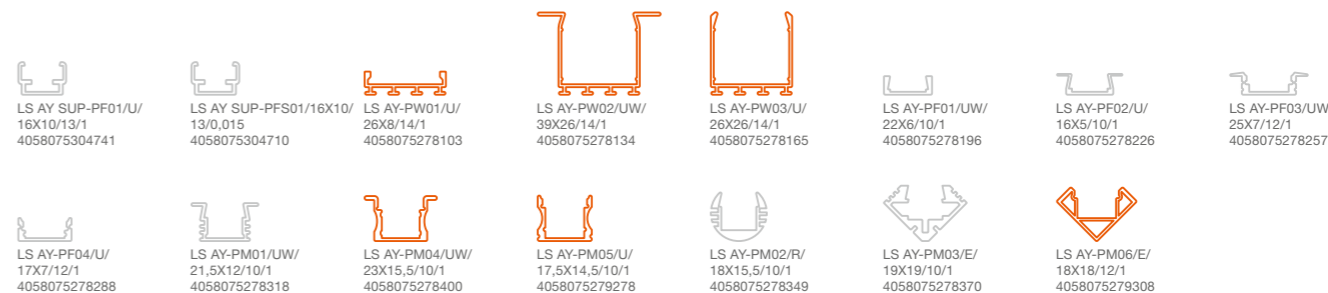

### DRIVERS

Extract from the versatile driver portfolio

► Details see chapter DRIVERS



DR DIM-PFM-60/220-240/24/P  
4058075379190

DR-PFM-60/220-240/24/P  
4058075239913

DR-VAL-60/220-240/24/P  
4058075240094

## LED STRIP VALUE-1400

LED strips with 1400 lm/m for general applications



Prewired cables on both sides

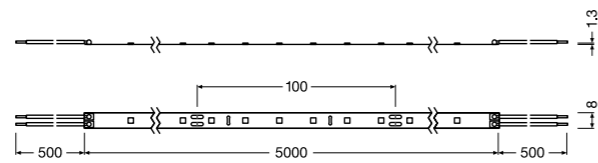

IP00 CRI >80 DIM



E-number	Product name	GTIN (EAN)	COLOR	K	lm <sup>2</sup> METER	lm	W <sup>2</sup> METER	W	lm/W <sup>2</sup>	V <sub>DC</sub>
LS VAL-1400/827/5		4058075296848	Warm white	2700	1400	5440	12.0	61.0	117.0	24
LS VAL-1400/830/5		4058075296879	White	3000	1420	5511	12.0	61.0	118.0	24
LS VAL-1400/840/5		4058075296909	Cool white	4000	1450	5618	12.0	61.0	121.0	24
LS VAL-1400/865/5		4058075296961	Daylight	6500	1450	5618	12.0	61.0	121.0	24

Product name	PITCH [mm]	α	IP	t <sub>inj</sub>	T <sub>a</sub>	L x W x H [mm]	CABLE LENGTH	Imax [mA]	PRICE (EUR)	PRICE (EUR)
LS VAL-1400/827/5	70	14.30	120	A+	20000	-20...+40	5000x8.0x1.3	500	100.0	
LS VAL-1400/830/5	70	14.30	120	A+	20000	-20...+40	5000x8.0x1.3	500	100.0	
LS VAL-1400/840/5	70	14.30	120	A+	20000	-20...+40	5000x8.0x1.3	500	100.0	
LS VAL-1400/865/5	70	14.30	120	A+	20000	-20...+40	5000x8.0x1.3	500	100.0	

<sup>1</sup> Dimmable with suitable drivers, see also www.ledvance.com/dim | <sup>2</sup> Value based on first meter of the product | <sup>3</sup> L70/B50 at Tc max. 65°C | <sup>4</sup> Recommended retail price excl. VAT

### STRIP ACCESSORIES

Extract from the system components of the extensive LED Strip accessories

► Details see chapter STRIP ACCESSORIES

CONNECTORS

ENDCAPS

MOUNTING BRACKETS

### PROFILES

Matching profiles (orange) with corresponding covers and installation accessories

► Details see chapter PROFILES

LS AY SUP-PF01/U/ 16X10/13/1 4058075304741

LS AY SUP-PFS01/16X10/ 13/0,015 4058075304710

LS AY-PW01/U/ 26X8/14/1 4058075278103

LS AY-PW02/UW/ 39X26/14/1 4058075278134

LS AY-PW03/U/ 26X26/14/1 4058075278165

LS AY-PF01/UW/ 22X6/10/1 4058075278196

LS AY-PF02/U/ 16X5/10/1 4058075278226

LS AY-PF03/UW/ 25X7/12/1 4058075278257

LS AY-PF04/U/ 17X7/12/1 4058075278288

LS AY-PM01/UW/ 21,5X12/10/1 4058075278318

LS AY-PM04/UW/ 23X15,5/10/1 4058075278400

LS AY-PM05/U/ 17,5X14,5/10/1 4058075279278

LS AY-PM02/R/ 18X15,5/10/1 4058075278349

LS AY-PM03/E/ 19X19/10/1 4058075278370

LS AY-PM06/E/ 18X18/12/1 4058075279308

### DRIVERS

Extract from the versatile driver portfolio

► Details see chapter DRIVERS

DR DIM-PFM-100/220-240/24/P 4058075240070

DR-PFM-100/220-240/24/P 4058075239937

DR-VAL-120/220-240/24 4058075240131

## LED STRIP VALUE-1400 PROTECTED

IP65 protected LED strips with 1400 lm/m for general applications



Prewired cables on both sides

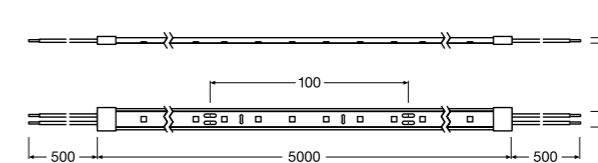

IP65 CRI >80 DIM



E-number	Product name	GTIN (EAN)	COLOR	K	lm <sup>2</sup> METER	lm	W <sup>2</sup> METER	W	lm/W <sup>2</sup>	V <sub>DC</sub>
LS VAL-1400/827/5/IP65		4058075296695	Warm white	2700	1320	5129	12.0	61.0	110.0	24
LS VAL-1400/830/5/IP65		4058075296725	White	3000	1340	5200	12.0	61.0	112.0	24
LS VAL-1400/840/5/IP65		4058075296756	Cool white	4000	1370	5511	12.0	61.0	114.0	24
LS VAL-1400/865/5/IP65		4058075296817	Daylight	6500	1370	5511	12.0	61.0	114.0	24

Product name	PITCH [mm]	α	IP	t <sub>inj</sub>	T <sub>a</sub>	L x W x H [mm]	CABLE LENGTH	Imax [mA]	PRICE (EUR)	PRICE (EUR)
LS VAL-1400/827/5/IP65	70	14.30	105	A+	20000	-20...+40	5000x10.0x4.1	500	100.0	
LS VAL-1400/830/5/IP65	70	14.30	105	A+	20000	-20...+40	5000x10.0x4.1	500	100.0	
LS VAL-1400/840/5/IP65	70	14.30	105	A+	20000	-20...+40	5000x10.0x4.1	500	100.0	
LS VAL-1400/865/5/IP65	70	14.30	105	A+	20000	-20...+40	5000x10.0x4.1	500	100.0	

<sup>1</sup> Dimmable with suitable drivers, see also www.ledvance.com/dim | <sup>2</sup> Value based on first meter of the product | <sup>3</sup> L70/B50 at Tc max. 65°C | <sup>4</sup> Recommended retail price excl. VAT

### STRIP ACCESSORIES

Extract from the system components of the extensive LED Strip accessories

► Details see chapter STRIP ACCESSORIES

CONNECTORS

ENDCAPS

MOUNTING BRACKETS



### PROFILES

Matching profiles (orange) with corresponding covers and installation accessories

► Details see chapter PROFILES

LS AY SUP-PF01/U/ 16X10/13/1 4058075304741

LS AY SUP-PFS01/16X10/ 13/0,015 4058075304710

LS AY-PW01/U/ 26X8/14/1 4058075278103

LS AY-PW02/UW/ 39X26/14/1 4058075278134

LS AY-PW03/U/ 26X26/14/1 4058075278165

LS AY-PF01/UW/ 22X6/10/1 4058075278196

LS AY-PF02/U/ 16X5/10/1 4058075278226

LS AY-PF03/UW/ 25X7/12/1 4058075278257

LS AY-PF04/U/ 17X7/12/1 4058075278288

LS AY-PM01/UW/ 21,5X12/10/1 4058075278318

LS AY-PM04/UW/ 23X15,5/10/1 4058075278400

LS AY-PM05/U/ 17,5X14,5/10/1 4058075279278

LS AY-PM02/R/ 18X15,5/10/1 4058075278349

LS AY-PM03/E/ 19X19/10/1 4058075278370

LS AY-PM06/E/ 18X18/12/1 4058075279308

### DRIVERS

Extract from the versatile driver portfolio

► Details see chapter DRIVERS

DR DIM-PFM-100/220-240/24/P 4058075240070

DR-PFM-100/220-240/24/P 4058075239937

DR-VAL-120/220-240/24 4058075240131

# COLORFUL ACCENTS FOR A GREAT ATMOSPHERE

## LED STRIPS VALUE CLASS RGB

VALUE CLASS

RGB

From the primary colors red, green and blue, LEDVANCE RGB LED Strips produce a wide range of individually controllable colors with attractive saturation. In addition to reliable quality and a good price/performance ratio, high economy is ensured by simple installation and compatibility with profiles and covers. This makes RGB LED Strips ideal for providing colorful accents in private areas or small commercial and catering facilities. A single LED Strip is often sufficient for these applications. Thanks to IP65 rating, RGB LED Strips are also suitable for outdoor use.

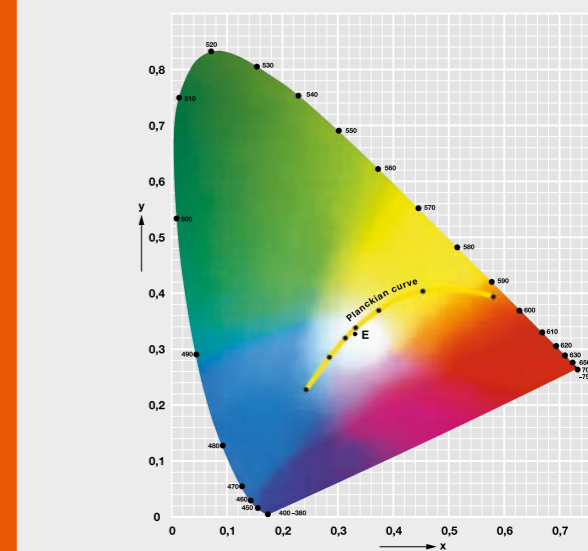

- A life of up to 40,000 hours<sup>1</sup>
- Color rendering index CRI ≥ 80
- Luminous flux of 500 lm/m – tailored for ambient, cove and general lighting
- RGB color mode
- Type of protection IP 00/65
- UV resistance (to IEC 60068-2-5) at IP65

### LIGHT TO SUIT YOUR MOOD

RGB LED Strips also allow for modern colorful ambient lighting in private areas. By means of a controller, users can add color to suit their mood and feel really comfortable.

### OUTDOOR ACCENTS

Our new RGB Protected LED Strips with IP65 protection are now also illuminating outdoor areas with striking colors. A multichannel controller with the relevant control unit makes it very easy to regulate the color change.

### WIDE COLOR SPECTRUM

The three primary light colors red, green and blue allow RGB LED Strips to reproduce a wide range of colors in additive color mixing. Especially impressive is the attractive color saturation.

<sup>1</sup> L70/B50 at T<sub>c</sub> max. 75 °C

### CONNECTION DIAGRAM FOR RGB LED STRIP

**Important!**  
In combination with the multi-channel controller and the RGB control elements, 24V DC LED drivers ensure correct and easy handling of multi-color operation.

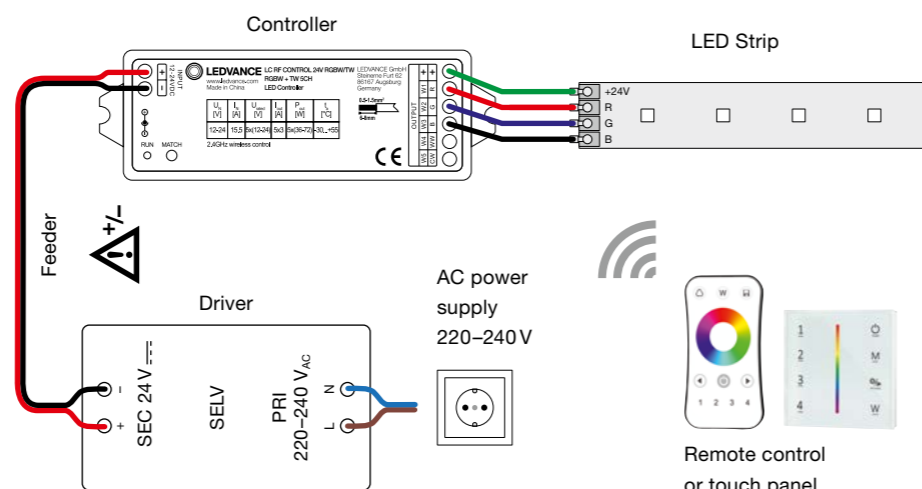

### CHECK: THIS IS HOW YOUR RGB LED STRIP SYSTEM WORKS



The RGB versions of the LEDVANCE LED Strips can be installed to suit individual planning. However, the following components are essential for a functioning RGB system.

#### System components for LEDVANCE RGB LED STRIP:

- Multichannel controller RGBW/TW: LC RF Controller 24V RGBW/TW
- RGB control elements: remote control (LC RF REMOTE RGBW) and/or touch panel (LC RF TOUCH PANEL RGBW)

Alternatively, you can use a DALI or DMX system.

### PRODUCT BENEFITS

- Great design freedom thanks to long, flexible RGB LED Strips
- Homogeneous color changes
- Easy mounting on many smooth surfaces with self-adhesive tape
- Easy installation and tool-free connection
- Suitable for use in damp environments thanks to high degree of protection (IP65)
- Simple connection thanks to integrated cables on both sides

### APPLICATIONS

- Suitable for indoor and outdoor use (IP65)
- Facade accent lighting
- Effect lighting in architecture
- Dynamic effects in public areas
- Cove lighting
- Under-shelf lighting
- Hotels and offices
- Homes

# LED STRIP VALUE-500 RGB

RGB LED strips with 500 lm/m for general applications



Prewired cables on both sides

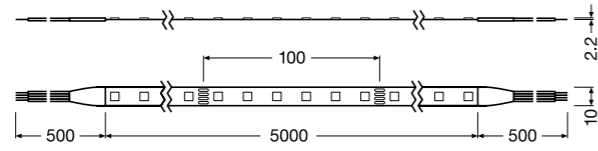

E-number	Product name	GTIN (EAN)	COLOR	K	lm <sup>2</sup> METER	lm	W <sup>2</sup> METER	W	lm/W <sup>2</sup>	V <sub>DC</sub>
LS VAL-500/RGB/5		4058075404441	RGB	-	535 / R 106 / G 325 / B 73	2400	14.4	67.0	37.2	24

Product name	METER	PITCH [mm]	°	IP	t <sub>inj</sub>	T <sub>a</sub>	L x W x H [mm]	CABLE LENGTH	↓ max. (mm)	PRICE (EUR)	PRICE METER (EUR)
LS VAL-500/RGB/5	60	16.70	120	-	40000	-20...+45	5000x10.0x2.2	500	100.0		

<sup>1</sup> Dimmable with suitable drivers, see also www.ledvance.com/dim | <sup>2</sup> Value based on first meter of the product | <sup>3</sup> L70/B50 at Tc max. 75 °C | <sup>4</sup> Recommended retail price excl. VAT

## STRIP ACCESSORIES

Extract from the system components of the extensive LED Strip accessories

► Details see chapter STRIP ACCESSORIES

### CONNECTORS



### ENDCAPS

### MOUNTING BRACKETS



## PROFILES

Matching profiles (orange) with corresponding covers and installation accessories

► Details see chapter PROFILES

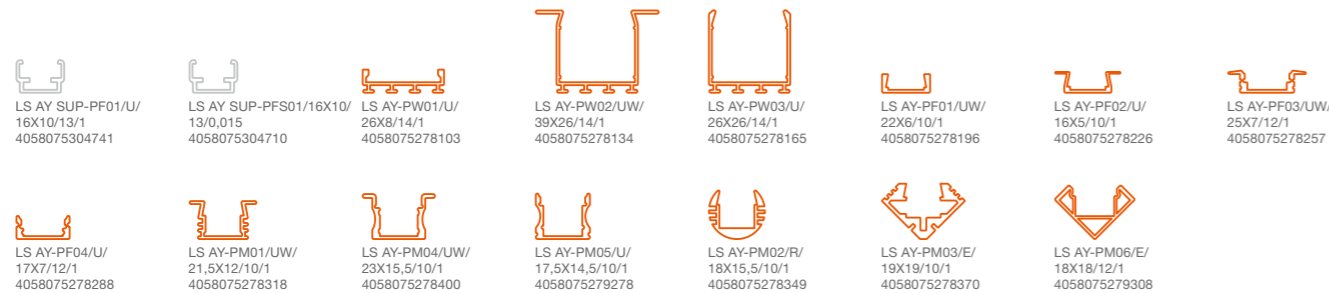

## DRIVERS

Extract from the versatile driver portfolio

► Details see chapter DRIVERS



# LED STRIP VALUE-500 RGB PROTECTED

IP65 protected RGB LED strips with 500 lm/m for general applications



Prewired cables on both sides

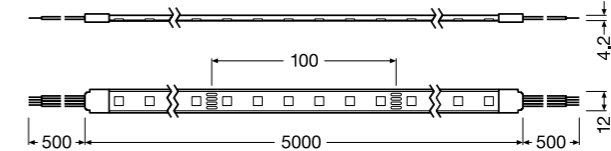

E-number	Product name	GTIN (EAN)	COLOR	K	lm <sup>2</sup> METER	lm	W <sup>2</sup> METER	W	lm/W <sup>2</sup>	V <sub>DC</sub>
LS VAL-500/RGB/5/IP65		4058075404472	RGB	-	485 / R 115 / G 355 / B 80	2150	14.4	67.0	33.7	24

Product name	METER	PITCH [mm]	°	IP	t <sub>inj</sub>	T <sub>a</sub>	L x W x H [mm]	CABLE LENGTH	↓ max. (mm)	PRICE (EUR)	PRICE METER (EUR)
LS VAL-500/RGB/5/IP65	60	16.70	120	-	40000	-20...+45	5000x12.5x4.2	500	100.0		

<sup>1</sup> Dimmable with suitable drivers, see also www.ledvance.com/dim | <sup>2</sup> Value based on first meter of the product | <sup>3</sup> L70/B50 at Tc max. 75 °C | <sup>4</sup> Recommended retail price excl. VAT

## STRIP ACCESSORIES

Extract from the system components of the extensive LED Strip accessories

► Details see chapter STRIP ACCESSORIES

### CONNECTORS



### ENDCAPS



### MOUNTING BRACKETS



## PROFILES

Matching profiles (orange) with corresponding covers and installation accessories

► Details see chapter PROFILES

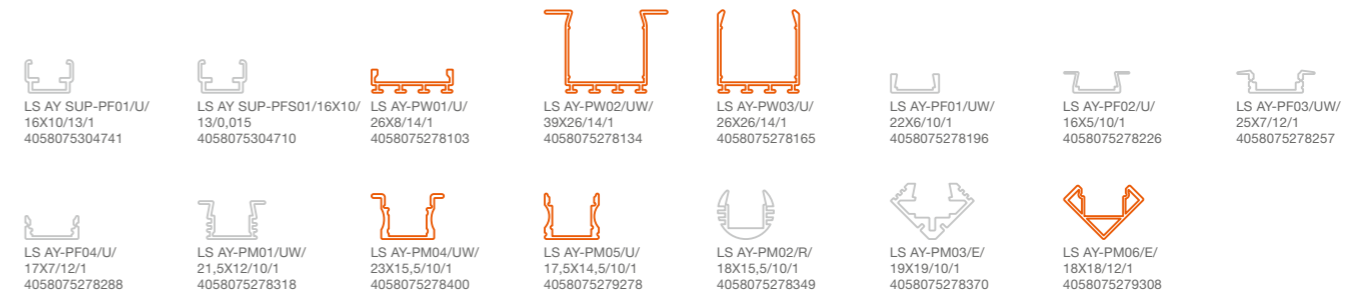

## DRIVERS

Extract from the versatile driver portfolio

► Details see chapter DRIVERS



# CONTROLLER, REMOTE CONTROL AND TOUCH PANEL TW/RGBW/RGB

## CONTROLLER



E-number	Product name	GTIN (EAN)	Product type	V <sub>in</sub> [VDC]	Operating frequency [GHZ]	Number of channels	Max. current/channel output [A]	Max. output W	L x W x H [mm]	Ambient temperature T <sub>a</sub>	Price [EUR] <sup>2</sup>
	LC RF CONTROL 24V RGBW/TW	4058075435834	Multichannel controller	12-24	2.4	5	5 x 3	5 x 72	114.0 x 38.0 x 20.0	-30...+55 °C	

## REMOTE CONTROL



E-number	Product name	GTIN (EAN)	Product type	V <sub>in</sub> [VDC]	Operating frequency [GHZ]	L x W x H [mm]	Ambient temperature T <sub>a</sub>	Price [EUR] <sup>2</sup>
	LC RF REMOTE TW	4058075435926	Remote control for TW LED Strips	3 CR2032	2.4	107.0 x 58.5 x 9.0	-20...+55 °C	
	LC RF REMOTE RGBW	4058075435858	Remote control for RGBW and RGB LED Strips	3 CR2032	2.4	107.0 x 58.5 x 9.0	-20...+55 °C	

## TOUCH PANEL



E-number	Product name	GTIN (EAN)	Product type	V <sub>in</sub> [VAC]	Operating frequency [GHZ]	L x W x H [mm]	Ambient temperature T <sub>a</sub>	Price [EUR] <sup>2</sup>
	LC RF TOUCH PANEL TW	4058075435940	Touch panel for TW LED Strips	100-240	2.4	86.0 x 86.0 x 33.0	-30...+55 °C	
	LC RF TOUCH PANEL RGBW	4058075435896	Touch panel for RGBW and RGB LED Strips	100-240	2.4	86.0 x 86.0 x 33.0	-30...+55 °C	

<sup>1</sup> Refer to [www.ledvance.com/guarantee](http://www.ledvance.com/guarantee) for precise conditions  
<sup>2</sup> Recommended retail price excl. VAT

### HOW THE WIRING WORKS USING THE EXAMPLE OF RGBW:

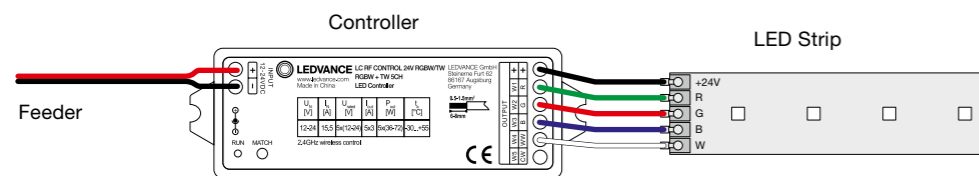

For details on the different wiring for TW/RGBW/RGB LED Strips see pages 16-17

# CONNECTORS, ENDCAPS, MOUNTING BRACKETS

## CONNECTORS



Product name	LS AY SUP-CP/P2/500	LS AY SUP-CSD/P2	LS AY SUP-CSW/P2/50	LS AY SUP-CSW/P2/500	LS AY SUP-CP/P3/500
Product type	Power Connector 2-Pin with 500 mm cable	Strip Connector 2-Pin	Strip Connector 2-Pin with 50 mm cable	Strip Connector 2-Pin with 500 mm cable	Power Connector 3-Pin with 500 mm cable
Compatibility	Details see chapter COMPATIBILITY				
E-Number					
GTIN (EAN)	4058075304413	4058075304444	4058075304475	4058075304505	4058075451322
L x W x H [mm]	510x9.8x5.7	9x9.8x5.7	70x9.8x5.7	520x9.8x5.7	24x14.6x7.7
UOP (Unit of Packaging)	2	2	2	2	2
Price [EUR] <sup>1</sup>					



Product name	LS AY SUP-CSD/P3	LS AY SUP-CSW/P3/50	LS AY SUP-CP/P3/500/P	LS AY SUP-CSD/P3/P	LS AY SUP-CSW/P3/50/P
Product type	Strip Connector 3-Pin	Strip Connector 3-Pin with 50 mm cable	Power Connector 3-Pin with 500 mm cable, protected	Strip Connector 3-Pin, protected	Strip Connector 3-Pin with 50 mm cable, protected
Compatibility	Details see chapter COMPATIBILITY				
E-Number					
GTIN (EAN)	4058075451353	4058075451384	4058075451414	4058075451445	4058075451537
L x W x H [mm]	20x14.6x7.7	24x14.6x7.7	26x17.0x7.2	27x17.0x7.2	26x17.0x7.2
UOP (Unit of Packaging)	2	2	2	2	2
Price [EUR] <sup>1</sup>					



Product name	LS AY PFM-CP/P2/500	LS AY PFM-CSD/P2	LS AY PFM-CSW/P2/50	LS AY PFM-CP/P2/500/P	LS AY PFM-CSD/P2/P
Product type	Power Connector 2-Pin with 500 mm cable	Strip Connector 2-Pin	Strip Connector 2-Pin with 50 mm cable	Power Connector 2-Pin with 500 mm cable, protected	Strip Connector 2-Pin protected
Compatibility	Details see chapter COMPATIBILITY				
E-Number					
GTIN (EAN)	4058075272200	4058075275393	4058075272231	4058075272958	4058075275485
L x W x H [mm]	532x10.4x4.5	21x11.0x4.5	66x10.4x4.5	552x15.0x7.0	27x15.0x7.0
UOP (Unit of Packaging)	2	2	2	2	2
Price [EUR] <sup>1</sup>					



Product name	LS AY PFM-CSW/P2/50/P	LS AY PFM-CP/P5/500	LS AY PFM-CSD/P5	LS AY PFM-CSW/P5/50	LS AY PFM-CP/P5/500/P
Product type	Strip Connector 2-Pin with 50 mm cable, protected	Power Connector 5-Pin with 500 mm cable	Strip Connector 5-Pin	Strip Connector 5-Pin with 50 mm cable	Power Connector 5-Pin with 500 mm cable, protected
Compatibility	Details see chapter COMPATIBILITY				
E-Number					
GTIN (EAN)	4058075273245	4058075451087	4058075451117	4058075451148	4058075451179
L x W x H [mm]	102x15.0x7.0	24x17.0x7.7	20x17.0x7.7	24x17.0x7.7	26x19.0x7.2
UOP (Unit of Packaging)	2	2	2	2	2
Price [EUR] <sup>1</sup>					

<sup>1</sup> Recommended retail price excl. VAT



## CONNECTORS, ENDCAPS, MOUNTING BRACKETS

### CONNECTORS



Product name	LS AY PFM-CSD/P5/P	LS AY PFM-CSW/P5/50/P	LS AY VAL-CP/P4/500	LS AY VAL-CSD/P4	LS AY VAL-CSW/P4/50
Product type	Strip Connector 5-Pin, protected	Strip Connector 5-Pin with 50 mm cable, protected	Power Connector 4-Pin with 500 mm cable	Strip Connector 4-Pin	Strip Connector 4-Pin with 50 mm cable
Compatibility	Details see chapter COMPATIBILITY				
E-Number					
GTIN (EAN)	4058075451209	4058075451230	4058075407800	4058075407831	4058075407862
L x W x H [mm]	27x19.0x7.2	26x19.0x7.2	515x14.6x7.7	20x14.6x7.7	99x14.6x7.7
UOP (Unit of Packaging)	2	2	2	2	2
Price [EUR] <sup>1</sup>					



Product name	LS AY VAL-CP/P4/500/P	LS AY VAL-CSD/P4/P	LS AY VAL-CSW/P4/50/P
Product type	Power Connector 4-Pin with 500 mm cable, protected	Strip Connector 4-Pin, protected	Strip Connector 4-Pin with 50 mm cable, protected
Compatibility	Details see chapter COMPATIBILITY		
E-Number			
GTIN (EAN)	4058075407893	4058075407923	4058075407954
L x W x H [mm]	516x17.0x7.0	27x17.0x7.0	102x17.0x7.0
UOP (Unit of Packaging)	2	2	2
Price [EUR] <sup>1</sup>			

### ENDCAPS



Product name	LS AY SUP-SE/P + SILICONE SEAL	LS AY SUP-12/SE/P SIL-SEAL	LS AY PFM-13/SE/P SIL-SEAL	LS AY PFM-10/SE/P SIL-SEAL	LS AY VAL-SE/P + SILICONE SEAL
Product type	4 Endcaps for 13 mm protected strip + 1 Silicone Seal	4 Endcaps for 12 mm protected strip + 1 Silicone Seal	4 Endcaps for 13 mm protected strip + 1 Silicone Seal	4 Endcaps for 10 mm protected strip + 1 Silicone Seal	4 Endcaps for 12 mm protected strip + 1 Silicone Seal
Compatibility	Details see chapter COMPATIBILITY				
E-Number					
GTIN (EAN)	4058075304659	4058075451568	4058075451261	4058075275744	4058075407985
L x W x H [mm]	17x11.0x6.5	13x10.0x6.0	15x10.0x6.0	12x6.5x10.0	14x10.0x6.0
UOP (Unit of Packaging)	4	4	4	4	4
Price [EUR] <sup>1</sup>					

### MOUNTING BRACKETS



Product name	LS AY SUP-12/SMB	LS AY PFM-8/SMB	LS AY PFM-10/SMB	LS AY PFM-13/SMB	LS AY VAL-12/SMB
Product type	Mounting bracket + 2 screws for 12 mm strip	Mounting bracket + 2 screws for 8 mm strip	Mounting bracket + 2 screws for 10 mm strip	Mounting bracket + 2 screws for 13 mm strip	Mounting bracket + 2 screws for 12 mm strip
Compatibility	Details see chapter COMPATIBILITY				
E-Number					
GTIN (EAN)	4058075451599	4058075275645	4058075275676	4058075451292	4058075411708
L x W x H [mm]	30x6.0x6.0	26x6.0x5.2	28x6.0x5.2	32x6.0x6.0	30x6.0x5.5
UOP (Unit of Packaging)	2	2	2	2	2
Price [EUR] <sup>1</sup>					

# ALL-ROUND GENIUSES LED STRIP SYSTEM PROFILES

They are the all-rounders in the LEDVANCE LED Strip System. The large number of different profiles in combination with the large selection of covers, end caps and mounting brackets ensure that the LED Strips can be used anywhere – on walls or ceilings, in corners or in furniture. The various covers provide protection and the profiles cool the LED components and ensure appropriate distribution of light. For example, for particularly homogeneous lighting you should use a diffuse cover and make sure that the distance between the LEDs is less than the distance between the LEDs and the cover.

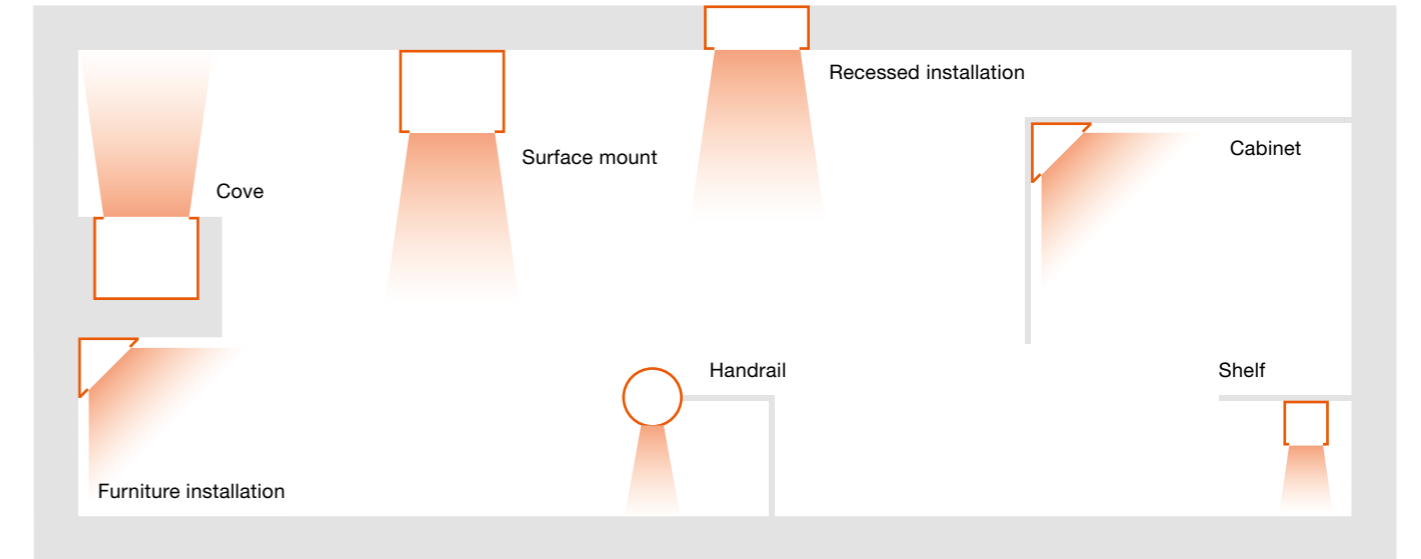

## PROFILES EXCLUSIVELY FOR LED STRIPS SUPERIOR CLASS

E-number	Product name	GTIN (EAN)	Product type	L x W x H [mm]	PRICE [EUR]	No.
----------	--------------	------------	--------------	----------------	-------------	-----

### Flat Profile for SUPERIOR CLASS LED Strip IP67, plastic

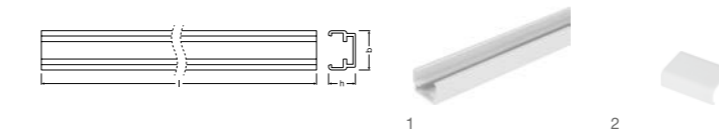

LS AY SUP-PF01/U/16X10/13/1	4058075304741	Flat Profile for SUPERIOR CLASS LED Strip IP67, plastic	1000 x 16.0 x 10.0	1	1
LS AY SUP-SEF	4058075304680	Endcap Fixing Clip	25 x 18.5 x 9.2	2	2

### Flat Profile Segment for SUPERIOR CLASS LED Strip IP67, plastic

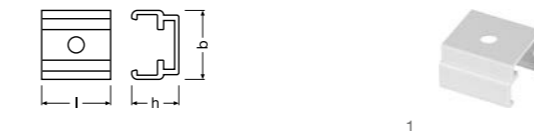

LS AY SUP-PFS01/16X10/13/0,015	4058075304710	Flat Profile Segment for SUPERIOR CLASS LED Strip IP67, plastic	15 x 16.0 x 10.0	2	1
--------------------------------	---------------	---	------------------	---	---

<sup>1</sup> Recommended retail price excl. VAT

<sup>1</sup> Recommended retail price excl. VAT

# PROFILES FOR LED STRIPS

E-number	Product name	GTIN (EAN)	Product type	L x W x H [mm]	PRICE (EUR)	No.
----------	--------------	------------	--------------	----------------	-------------	-----

## Wide U-Shape Profile, Aluminium



<b>LS AY-PW01/U/26X8/14/1</b>	4058075278103	Wide U-Shape Profile, Aluminium	1000 x 26.0 x 7.4	1	1
<b>LS AY-PW01/U/26X8/14/2</b>	4058075401440	Wide U-Shape Profile, Aluminium, 2 m long	2000 x 26.0 x 7.4	1	1
LS AY-PC/W01/D/1	4058075279391	Wide Cover for Profile PW01 (17,7 mm high), diffuse	1000 x 26.3 x 17.7	1	2
LS AY-PC/W01/D/2	4058075401952	Wide Cover for Profile PW01 (17,7 mm high), diffuse, 2 m long	2000 x 26.3 x 17.7	1	2
LS AY-PC/W01/C/1	4058075402317	Wide Cover for Profile PW01 (17,7 mm high), clear	1000 x 26.3 x 17.7	1	2
LS AY-PC/W01/C/2	4058075402133	Wide Cover for Profile PW01 (17,7 mm high), clear, 2 m long	2000 x 26.3 x 17.7	1	2
LS AY-PW01/EC/H	4058075277366	Endcap with Hole for Profile PW01	6 x 26.3 x 23.0	2	3
LS AY-PW01/EC	4058075277335	Endcap for Profile PW01	6 x 26.3 x 23.0	2	4
LS AY-PW01/MB	4058075276611	Mounting Bracket for Profile PW01	9 x 26.3 x 7.5	2	5

## Wide U-Shape Wing Profile, Aluminium



<b>LS AY-PW02/UW/39X26/14/1</b>	4058075278134	Wide U-Shape Wing Profile, Aluminium	1000 x 39.0 x 26.0	1	1
<b>LS AY-PW02/UW/39X26/14/2</b>	4058075401471	Wide U-Shape Wing Profile, Aluminium, 2 m long	2000 x 39.0 x 26.0	1	1
LS AY-PC/W02/D/1	4058075279421	Wide Cover for Profiles PW02, PW03, diffuse	1000 x 23.9 x 4.7	1	2
LS AY-PC/W02/D/2	4058075401983	Wide Cover for Profiles PW02, PW03, diffuse, 2 m long	2000 x 23.9 x 4.7	1	2
LS AY-PC/W02/C/1	4058075402348	Wide Cover for Profiles PW02, PW03, clear	1000 x 23.9 x 4.7	1	2
LS AY-PC/W02/C/2	4058075402164	Wide Cover for Profiles PW02, PW03, clear, 2 m long	2000 x 23.9 x 4.7	1	2
LS AY-PW02/EC/H	4058075277427	Endcap with Hole for Profile PW02	12 x 39.4 x 26.0	2	3
LS AY-PW02/EC	4058075277397	Endcap for Profile PW02	12 x 39.4 x 26.0	2	4
LS AY-PW02/MB	4058075276659	Mounting Bracket for Profile PW02	9 x 28.7 x 7.5	2	5

## Wide U-Shape Profile (26 mm high), Aluminium



<b>LS AY-PW03/U/26X26/14/1</b>	4058075278165	Wide U-Shape Profile (26 mm high), Aluminium	1000 x 26.0 x 26.0	1	1
<b>LS AY-PW03/U/26X26/14/2</b>	4058075401501	Wide U-Shape Profile (26 mm high), Aluminium, 2 m long	2000 x 26.0 x 26.0	1	1
LS AY-PC/W02/D/1	4058075279421	Wide Cover for Profiles PW02, PW03, diffuse	1000 x 23.9 x 4.7	1	2
LS AY-PC/W02/D/2	4058075401983	Wide Cover for Profiles PW02, PW03, diffuse, 2 m long	2000 x 23.9 x 4.7	1	2
LS AY-PC/W02/C/1	4058075402348	Wide Cover for Profiles PW02, PW03, clear	1000 x 23.9 x 4.7	1	2
LS AY-PC/W02/C/2	4058075402164	Wide Cover for Profiles PW02, PW03, clear, 2 m long	2000 x 23.9 x 4.7	1	2
LS AY-PW03/EC/H	4058075277489	Endcap with Hole for Profile PW03	7 x 26.0 x 26.0	2	3
LS AY-PW03/EC	4058075277458	Endcap for Profile PW03	7 x 26.0 x 26.0	2	4
LS AY-PW03/MB	4058075276680	Mounting Bracket for Profile PW03	9 x 28.7 x 7.5	2	5

# PROFILES FOR LED STRIPS

E-number	Product name	GTIN (EAN)	Product type	L x W x H [mm]	PRICE (EUR)	No.
----------	--------------	------------	--------------	----------------	-------------	-----

## Flat U-Shape Wing Profile, Aluminium



<b>LS AY-PF01/UW/22X6/10/1</b>	4058075278196	Flat U-Shape Wing Profile, Aluminium	1000 x 22.0 x 6.0	1	1
<b>LS AY-PF01/UW/22X6/10/2</b>	4058075401532	Flat U-Shape Wing Profile, Aluminium, 2 m long	2000 x 22.0 x 6.0	1	1
LS AY-PC/P02/D/1	4058075305762	Plain Cover for Profiles PF01, PM01, diffuse	1000 x 13.2 x 4.4	1	2
LS AY-PC/P02/D/2	4058075401860	Plain Cover for Profiles PF01, PM01, diffuse, 2 m long	2000 x 13.2 x 4.4	1	2
LS AY-PC/P02/C/1	4058075402225	Plain Cover for Profiles PF01, PM01, clear	1000 x 13.2 x 4.4	1	2
LS AY-PC/P02/C/2	4058075402041	Plain Cover for Profiles PF01, PM01, clear, 2 m long	2000 x 13.2 x 4.4	1	2
LS AY-PF01/EC/H	4058075277540	Endcap with Hole for Profile PF01	20 x 21.7 x 6.7	2	3
LS AY-PF01/EC	4058075277519	Endcap for Profile PF01	20 x 21.7 x 6.7	2	4
LS AY-PF01/MB	4058075276710	Mounting Bracket for Profile PF01	20 x 18.8 x 7.2	2	5

## Flat U-Shape Profile, Aluminium



<b>LS AY-PF02/U/16X5/10/1</b>	4058075278226	Flat U-Shape Profile, Aluminium	1000 x 16.0 x 5.0	1	1
<b>LS AY-PF02/U/16X5/10/2</b>	4058075401563	Flat U-Shape Profile, Aluminium, 2 m long	2000 x 16.0 x 5.0	1	1
LS AY-PC/P01/D/1	4058075279339	Plain Cover for Profiles PF02, PM02, PM03, diffuse	1000 x 12.7 x 4.4	1	2
LS AY-PC/P01/D/2	4058075401839	Plain Cover for Profiles PF02, PM02, PM03, diffuse, 2 m long	2000 x 12.7 x 4.4	1	2
LS AY-PC/P01/C/1	4058075402195	Plain Cover for Profiles PF02, PM02, PM03, clear	1000 x 12.7 x 4.4	1	2
LS AY-PC/P01/C/2	4058075402010	Plain Cover for Profiles PF02, PM02, PM03, clear, 2 m long	2000 x 12.7 x 4.4	1	2
LS AY-PF02/EC/H	4058075277601	Endcap with Hole for Profile PF02	12 x 15.5 x 5.8	2	3
LS AY-PF02/EC	4058075277571	Endcap for Profile PF02	12 x 15.5 x 5.8	2	4
LS AY-PF02/MB	4058075276741	Mounting Bracket for Profile PF02	20 x 18.8 x 7.2	2	5

## Flat U-Shape Wing Profile (12 mm wide), Aluminium



<b>LS AY-PF03/UW/25X7/12/1</b>	4058075278257	Flat U-Shape Wing Profile (12 mm wide), Aluminium	1000 x 25.0 x 7.0	1	1
<b>LS AY-PF03/UW/25X7/12/2</b>	4058075401594	Flat U-Shape Wing Profile (12 mm wide), Aluminium, 2 m long	2000 x 25.0 x 7.0	1	1
LS AY-PC/R01/D/1	4058075279360	Round Cover for Profiles PM05, PM06, PF03, PF04, diffuse	1000 x 15.2 x 4.7	1	2
LS AY-PC/R01/D/2	4058075401891	Round Cover for Profiles PM05, PM06, PF03, PF04, diffuse, 2 m long	2000 x 15.2 x 4.7	1	2
LS AY-PC/R01/C/1	4058075402256	Round Cover for Profiles PM05, PM06, PF03, PF04, clear	1000 x 15.2 x 4.7	1	2
LS AY-PC/R01/C/2	4058075402072	Round Cover for Profiles PM05, PM06, PF03, PF04, clear, 2 m long	2000 x 15.2 x 4.7	1	2
LS AY-PF03/EC/H	4058075277663	Endcap with Hole for Profile PF03	8 x 25.0 x 8.3	2	3
LS AY-PF03/EC	4058075277632	Endcap for Profile PF03	8 x 25.0 x 8.3	2	4
LS AY-PF03/MB	4058075276772	Mounting Bracket for Profile PF03	15 x 21.4 x 7.2	2	5

<sup>1</sup> Recommended retail price excl. VAT

<sup>1</sup> Recommended retail price excl. VAT

# PROFILES FOR LED STRIPS

E-number	Product name	GTIN (EAN)	Product type	L x W x H [mm]	PRICE (EUR)	No.
----------	--------------	------------	--------------	----------------	-------------	-----

## Flat U-Shape Profile (12 mm wide), Aluminium



<b>LS AY-PF04/U/17X7/12/1</b>	4058075278288	Flat U-Shape Profile (12 mm wide), Aluminium	1000 x 17.0 x 7.0	1	1
<b>LS AY-PF04/U/17X7/12/2</b>	4058075401624	Flat U-Shape Profile (12 mm wide), Aluminium, 2 m long	2000 x 17.0 x 7.0	1	1
LS AY-PC/R01/D/1	4058075279360	Round Cover for Profiles PM05, PM06, PF03, PF04, diffuse	1000 x 15.2 x 4.7	1	2
LS AY-PC/R01/D/2	4058075401891	Round Cover for Profiles PM05, PM06, PF03, PF04, diffuse, 2 m long	2000 x 15.2 x 4.7	1	2
LS AY-PC/R01/C/1	4058075402256	Round Cover for Profiles PM05, PM06, PF03, PF04, clear	1000 x 15.2 x 4.7	1	2
LS AY-PC/R01/C/2	4058075402072	Round Cover for Profiles PM05, PM06, PF03, PF04, clear, 2 m long	2000 x 15.2 x 4.7	1	2
LS AY-PF04/EC/H	4058075277724	Endcap with Hole for Profile PF04	6 x 17.3 x 8.3	2	3
LS AY-PF04/EC	4058075277694	Endcap for Profile PF04	6 x 17.3 x 8.3	2	4
LS AY-PF04/MB	4058075276857	Mounting Bracket for Profile PF04	15 x 21.4 x 7.2	2	5

## Medium U-Shape Wing Profile, Aluminium



<b>LS AY-PM01/UW/21,5X12/10/1</b>	4058075278318	Medium U-Shape Wing Profile, Aluminium	1000 x 21.5 x 12.0	1	1
<b>LS AY-PM01/UW/21,5X12/10/2</b>	4058075401655	Medium U-Shape Wing Profile, Aluminium, 2 m long	2000 x 21.5 x 12.0	1	1
LS AY-PC/P02/D/1	4058075305762	Plain Cover for Profiles PF01, PM01, diffuse	1000 x 13.2 x 4.4	1	2
LS AY-PC/P02/D/2	4058075401860	Plain Cover for Profiles PF01, PM01, diffuse, 2 m long	2000 x 13.2 x 4.4	1	2
LS AY-PC/P02/C/1	4058075402225	Plain Cover for Profiles PF01, PM01, clear	1000 x 13.2 x 4.4	1	2
LS AY-PC/P02/C/2	4058075402041	Plain Cover for Profiles PF01, PM01, clear, 2 m long	2000 x 13.2 x 4.4	1	2
LS AY-PM01/EC/H	4058075277786	Endcap with Hole for Profile PM01	20 x 21.7 x 12.0	2	3
LS AY-PM01/EC	4058075277755	Endcap for Profile PM01	20 x 21.7 x 12.0	2	4
LS AY-PM01/MB	4058075276888	Mounting Bracket for Profile PM01	20 x 18.8 x 7.2	2	5

## Medium U-Shape Wing Profile (15,5 mm high), Aluminium



<b>LS AY-PM04/UW/23X15,5/10/1</b>	4058075278400	Medium U-Shape Wing Profile (15,5 mm high), Aluminium	1000 x 23.0 x 15.5	1	1
<b>LS AY-PM04/UW/23X15,5/10/2</b>	4058075401747	Medium U-Shape Wing Profile (15,5 mm high), Aluminium, 2 m long	2000 x 23.0 x 15.5	1	1
LS AY-PC/R02/D/1	4058075305793	Round Cover for Profile PM04, diffuse	1000 x 15.6 x 4.4	1	2
LS AY-PC/R02/D/2	4058075401921	Round Cover for Profile PM04, diffuse, 2 m long	2000 x 15.6 x 4.4	1	2
LS AY-PC/R02/C/1	4058075402287	Round Cover for Profile PM04, clear	1000 x 15.6 x 4.4	1	2
LS AY-PC/R02/C/2	4058075402102	Round Cover for Profile PM04, clear, 2 m long	2000 x 15.6 x 4.4	1	2
LS AY-PM04/EC/H	4058075275836	Endcap with Hole for Profile PM04	10 x 23.0 x 14.4	2	3
LS AY-PM04/EC	4058075277939	Endcap for Profile PM04	10 x 23.0 x 14.4	2	4
LS AY-PM04/MB	4058075276970	Mounting Bracket for Profile PM04	15 x 18.5 x 10.6	2	5

<sup>1</sup> Recommended retail price excl. VAT

# PROFILES FOR LED STRIPS

E-number	Product name	GTIN (EAN)	Product type	L x W x H [mm]	PRICE (EUR)	No.
----------	--------------	------------	--------------	----------------	-------------	-----

## Medium U-Shape Profile, Aluminium



<b>LS AY-PM05/U/17,5X14,5/10/1</b>	4058075279278	Medium U-Shape Profile, Aluminium	1000 x 17.5 x 14.5	1	1
<b>LS AY-PM05/U/17,5X14,5/10/2</b>	4058075401778	Medium U-Shape Profile, Aluminium, 2 m long	2000 x 17.5 x 14.5	1	1
LS AY-PC/R01/D/1	4058075279360	Round Cover for Profiles PM05, PM06, PF03, PF04, diffuse	1000 x 15.2 x 4.7	1	2
LS AY-PC/R01/D/2	4058075401891	Round Cover for Profiles PM05, PM06, PF03, PF04, diffuse, 2 m long	2000 x 15.2 x 4.7	1	2
LS AY-PC/R01/C/1	4058075402256	Round Cover for Profiles PM05, PM06, PF03, PF04, clear	1000 x 15.2 x 4.7	1	2
LS AY-PC/R01/C/2	4058075402072	Round Cover for Profiles PM05, PM06, PF03, PF04, clear, 2 m long	2000 x 15.2 x 4.7	1	2
LS AY-PM05/EC/H	4058075276529	Endcap with Hole for Profile PM05	7 x 17.3 x 20.0	2	3
LS AY-PM05/EC	4058075275867	Endcap for Profile PM05	7 x 17.3 x 20.0	2	4
LS AY-PM05/MB	4058075277007	Mounting Bracket for Profile PM05	15 x 21.4 x 7.2	2	5

## Medium Round Shape Profile, Aluminium



<b>LS AY-PM02/R/18X15,5/10/1</b>	4058075278349	Medium Round Shape Profile, Aluminium	1000 x 18.0 x 15.5	1	1
<b>LS AY-PM02/R/18X15,5/10/2</b>	4058075401686	Medium Round Shape Profile, Aluminium, 2 m long	2000 x 18.0 x 15.5	1	1
LS AY-PC/P01/D/1	4058075279339	Plain Cover for Profiles PF02, PM02, PM03, diffuse	1000 x 12.7 x 4.4	1	2
LS AY-PC/P01/D/2	4058075401839	Plain Cover for Profiles PF02, PM02, PM03, diffuse, 2 m long	2000 x 12.7 x 4.4	1	2
LS AY-PC/P01/C/1	4058075402195	Plain Cover for Profiles PF02, PM02, PM03, clear	1000 x 12.7 x 4.4	1	2
LS AY-PC/P01/C/2	4058075402010	Plain Cover for Profiles PF02, PM02, PM03, clear, 2 m long	2000 x 12.7 x 4.4	1	2
LS AY-PM02/EC/H	4058075277847	Endcap with Hole for Profile PM02	12 x 18.1 x 15.6	2	3
LS AY-PM02/EC	4058075277816	Endcap for Profile PM02	12 x 18.1 x 15.6	2	4
LS AY-PM02/MB	4058075276918	Mounting Bracket for Profile PM02	20 x 18.8 x 7.2	2	5

## Medium Edge Shape Profile, Aluminium



<b>LS AY-PM03/E/19X19/10/1</b>	4058075278370	Medium Edge Shape Profile, Aluminium	1000 x 19.0 x 19.0	1	1
<b>LS AY-PM03/E/19X19/10/2</b>	4058075401716	Medium Edge Shape Profile, Aluminium, 2 m long	2000 x 19.0 x 19.0	1	1
LS AY-PC/P01/D/1	4058075279339	Plain Cover for Profiles PF02, PM02, PM03, diffuse	1000 x 12.7 x 4.4	1	2
LS AY-PC/P01/D/2	4058075401839	Plain Cover for Profiles PF02, PM02, PM03, diffuse, 2 m long	2000 x 12.7 x 4.4	1	2
LS AY-PC/P01/C/1	4058075402195	Plain Cover for Profiles PF02, PM02, PM03, clear	1000 x 12.7 x 4.4	1	2
LS AY-PC/P01/C/2	4058075402010	Plain Cover for Profiles PF02, PM02, PM03, clear, 2 m long	2000 x 12.7 x 4.4	1	2
LS AY-PM03/EC/H	4058075277908	Endcap with Hole for Profile PM03	12 x 26.6 x 17.4	2	3
LS AY-PM03/EC	4058075277878	Endcap for Profile PM03	12 x 26.6 x 17.4	2	4
LS AY-PM03/MB	4058075276949	Mounting Bracket for Profile PM03	12 x 20.0 x 8.0	2	5

<sup>1</sup> Recommended retail price excl. VAT

## PROFILES FOR LED STRIPS

E-number	Product name	GTIN (EAN)	Product type	L x W x H [mm]	PRICE (EUR)	No.
<b>Medium Edge Shape Profile (12 mm wide), Aluminium</b>						
LS AY-PM06/E/18X18/12/1	Medium Edge Shape Profile (12 mm wide), Aluminium	4058075279308	Medium Edge Shape Profile (12 mm wide), Aluminium	1000 x 18.0 x 18.0	1	1
LS AY-PM06/E/18X18/12/2	Medium Edge Shape Profile (12 mm wide), Aluminium, 2 m long	4058075401808	Medium Edge Shape Profile (12 mm wide), Aluminium, 2 m long	2000 x 18.0 x 18.0	1	1
LS AY-PC/R01/D/1	Round Cover for Profiles PM05, PM06, PF03, PF04, diffuse	4058075279360	Round Cover for Profiles PM05, PM06, PF03, PF04, diffuse	1000 x 15.2 x 4.7	1	2
LS AY-PC/R01/D/2	Round Cover for Profiles PM05, PM06, PF03, PF04, diffuse, 2 m long	4058075401891	Round Cover for Profiles PM05, PM06, PF03, PF04, diffuse, 2 m long	2000 x 15.2 x 4.7	1	2
LS AY-PC/R01/C/1	Round Cover for Profiles PM05, PM06, PF03, PF04, clear	4058075402256	Round Cover for Profiles PM05, PM06, PF03, PF04, clear	1000 x 15.2 x 4.7	1	2
LS AY-PC/R01/C/2	Round Cover for Profiles PM05, PM06, PF03, PF04, clear, 2 m long	4058075402072	Round Cover for Profiles PM05, PM06, PF03, PF04, clear, 2 m long	2000 x 15.2 x 4.7	1	2
LS AY-PM06/EC/H	Endcap with Hole for Profile PM06	4058075276581	Endcap with Hole for Profile PM06	6 x 18.1 x 18.1	2	3
LS AY-PM06/EC	Endcap for Profile PM06	4058075276550	Endcap for Profile PM06	6 x 18.1 x 18.1	2	4
LS AY-PM06/MB	Mounting Bracket for Profile PM06	4058075277038	Mounting Bracket for Profile PM06	14 x 19.8 x 19.8	2	5

# RELIABLE AND VERSATILE LEDVANCE LED DRIVERS FOR CONSTANT VOLTAGE

Only with the right drivers for constant voltage (CV) you can unleash the full potential of modern lighting with LED Strips. At LEDVANCE you get everything from a single source.



The SELV-insulated constant voltage LED drivers from LEDVANCE are perfectly matched to LEDVANCE LED Strips. A portfolio of dimmable and non-dimmable versions for professional

indoor and outdoor applications gives you a wide variety of combinations to cover virtually any requirements. Integrated cable clamps allow for easy installation, reducing your time and

costs. Other strong arguments include the option of IP66 protection and a life of up to 50,000 hours<sup>1</sup>. Why should you settle for anything less?

SUPERIOR CLASS

PERFORMANCE CLASS

VALUE CLASS



<sup>1</sup> Recommended retail price excl. VAT

<sup>1</sup> At max. T<sub>a</sub> temperature

## LED DRIVER DALI SUPERIOR

Constant voltage LED driver with DALI dimming interface



### PRODUCT BENEFITS

- Quick and comfortable installation thanks to tool-less cable clamp concept
- 5 years guarantee
- Low flickering enables high light quality as well as good visual comfort
- Push DIM application for easy control
- Suitable for emergency lighting

### AREAS OF APPLICATION

- Cove lighting, even in tight spaces
- Hotels, shops, hospitality, residential interiors
- Museums, art galleries
- Strip lighting in single and open-plan offices
- Suitable for use in emergency lighting systems (DC capable)

E-number	Product name	GTIN (EAN)	V	V <sub>OUT</sub>	W	Hz	W	t <sub>inj</sub> <sup>2</sup>
	DR DALI-SUP-45/220-240/24	4058075421820	220...240	24	45.0	50/60	1...100	50000
	DR DALI-SUP-80/220-240/24	4058075421844	220...240	24	80.0	50/60	1...100	50000
	DR DALI-SUP-150/220-240/24	4058075421868	220...240	24	150.0	50/60	1...100	50000

Product name	T <sub>a</sub>	T <sub>c</sub>	PROTECTION CLASS	L x W x H [mm]	PRICE (EUR) <sup>3</sup>	Light bulb icon
DR DALI-SUP-45/220-240/24	-20...+50	85.0	II	229 x 47.0 x 32.0		1
DR DALI-SUP-80/220-240/24	-20...+45	85.0	II	330 x 47.0 x 32.0		2
DR DALI-SUP-150/220-240/24	-20...+45	85.0	II	330 x 47.0 x 32.0		3

## LED DRIVER SUP

Constant voltage LED driver

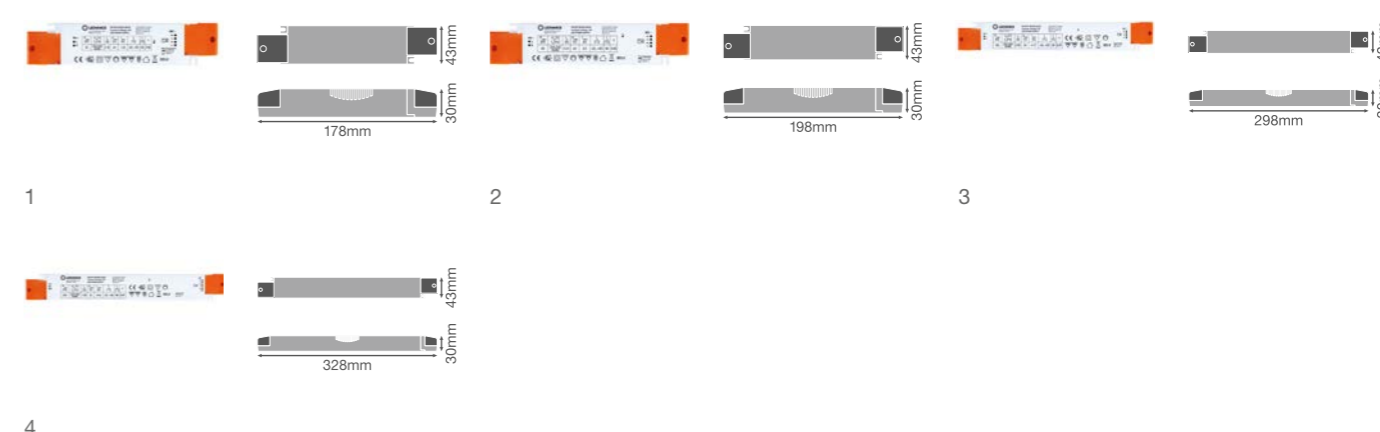

### PRODUCT BENEFITS

- Perfectly matched to 24 V LED flexible strips
- Long reliable life at maximum permitted temperatures
- 5 years guarantee
- Maintenance-free operation and minimal installation costs
- Quick and simple installation
- High efficiency and reliability

### AREAS OF APPLICATION

- Cove lighting, even in tight spaces
- Wallwasher effect lighting in living rooms, dining rooms, bedrooms, entrances
- Offices, shopping centers, hospitals, restaurants, hotels
- For indoor SELV installations

E-number	Product name	GTIN (EAN)	V	V <sub>OUT</sub>	W	Hz	W	t <sub>inj</sub>
	DR-SUP-30/220-240/24	4058075437784	220...240	24	30.0	50/60	-	60000
	DR-SUP-60/220-240/24	4058075437807	220...240	24	60.0	50/60	-	60000
	DR-SUP-100/220-240/24	4058075437821	220...240	24	100.0	50/60	-	60000
	DR-SUP-200/220-240/24	4058075437845	220...240	24	200.0	50/60	-	60000

Product name	T <sub>a</sub>	T <sub>c</sub>	PROTECTION CLASS	L x W x H [mm]	PRICE (EUR) <sup>3</sup>	Light bulb icon
DR-SUP-30/220-240/24	-20...+55	80.0	II	178 x 43.0 x 30.0		1
DR-SUP-60/220-240/24	-20...+55	90.0	II	198 x 43.0 x 30.0		2
DR-SUP-100/220-240/24	-20...+55	85.0	II	298 x 43.0 x 30.0		3
DR-SUP-200/220-240/24	-20...+55	90.0	II	328 x 73.0 x 30.0		4

<sup>1</sup> Refer to www.ledvance.com/guarantee for precise conditions | <sup>2</sup> At maximum T<sub>c</sub> = 75°C / 10% failure rate | <sup>3</sup> Recommended retail price excl. VAT

<sup>1</sup> Refer to www.ledvance.com/guarantee for precise conditions | <sup>2</sup> Recommended retail price excl. VAT

## LED DRIVER 1-10 V DIM OUTDOOR PERFORMANCE



Constant voltage outdoor LED driver with 1-10 V dimming interface

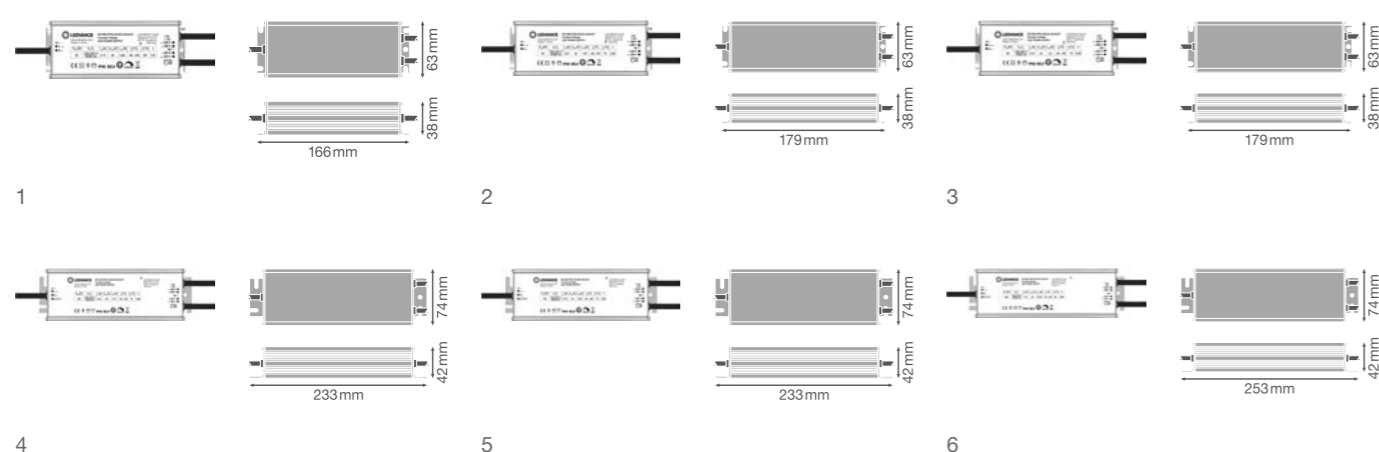

### PRODUCT BENEFITS

- Perfectly matched to 24 V LED flexible strips
- 5 years guarantee
- Very stable output power
- Quick and simple installation due to prewiring
- High efficiency and reliability
- Installation in very cold and hot environments

### AREAS OF APPLICATION

- Suitable for indoor and outdoor installations
- Facade and building illumination
- Ideal for illuminating public spaces
- Bathrooms, kitchens and outdoor areas
- Offices, shopping centers, hospitals, restaurants, hotels

E-number	Product name	GTIN (EAN)	V	V <sub>OUT</sub>	W	Hz	W	t <sub>inj</sub> <sup>2</sup>
	DR DIM-PFM-20/220-240/24/P	4058075239951	220...240	24	20.0	50/60	10...100	50000 <sup>bl</sup>
	DR DIM-PFM-40/220-240/24/P	4058075379176	220...240	24	40.0	50/60	10...100	50000 <sup>bl</sup>
	DR DIM-PFM-60/220-240/24/P	4058075379190	220...240	24	60.0	50/60	10...100	50000 <sup>bl</sup>
	DR DIM-PFM-100/220-240/24/P	4058075240070	220...240	24	100.0	50/60	10...100	50000 <sup>cl</sup>
	DR DIM-PFM-150/220-240/24/P	4058075240117	220...240	24	150.0	50/60	10...100	50000 <sup>bl</sup>
	DR DIM-PFM-250/220-240/24/P	4058075240155	220...240	24	250.0	50/60	10...100	50000 <sup>cl</sup>

Product name	T <sub>a</sub>	T <sub>c</sub>	PROTECTION CLASS	L x W x H [mm]	PRICE (EUR) <sup>3</sup>	No.
DR DIM-PFM-20/220-240/24/P	-40...+50	65.0	II	166 x 63.0 x 38.0		1
DR DIM-PFM-40/220-240/24/P	-40...+50	75.0	II	179 x 63.0 x 38.0		2
DR DIM-PFM-60/220-240/24/P	-40...+50	75.0	II	179 x 63.0 x 38.0		3
DR DIM-PFM-100/220-240/24/P	-40...+50	70.0	I	233 x 74.0 x 42.0		4
DR DIM-PFM-150/220-240/24/P	-40...+50	75.0	I	233 x 74.0 x 42.0		5
DR DIM-PFM-250/220-240/24/P	-40...+50	85.0	I	253 x 74.0 x 42.0		6

<sup>1</sup> Refer to www.ledvance.com/guarantee for precise conditions | <sup>2</sup> a) At maximum T<sub>c</sub> = 65°C / 10% failure rate; b) At maximum T<sub>c</sub> = 75°C / 10% failure rate; c) At maximum T<sub>c</sub> = 70°C / 10% failure rate; d) At maximum T<sub>c</sub> = 85°C / 10% failure rate | <sup>3</sup> Recommended retail price excl. VAT

## LED DRIVER OUTDOOR PERFORMANCE



Constant voltage outdoor LED driver

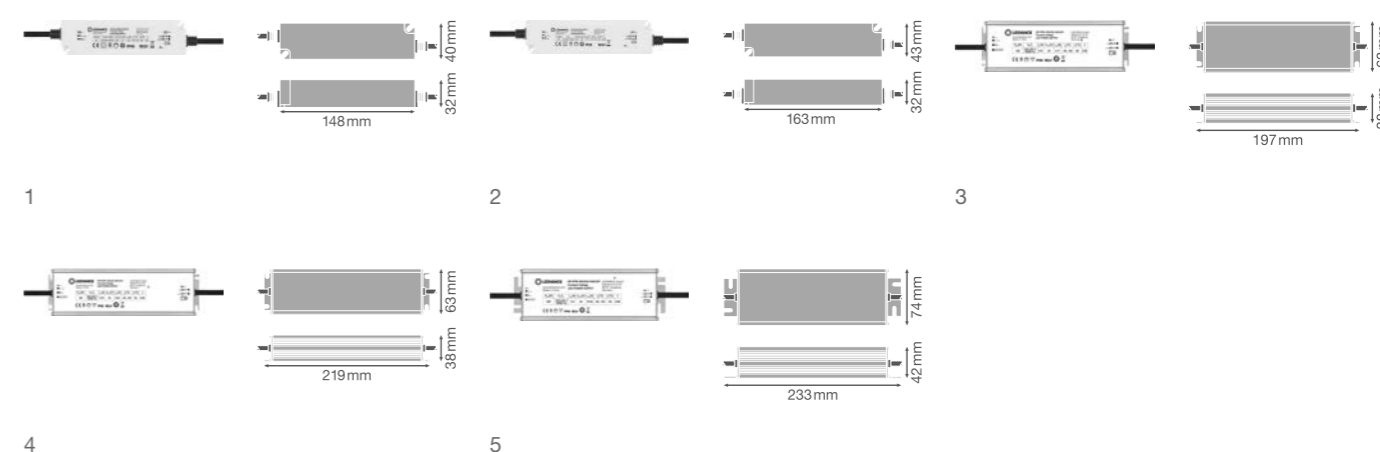

### PRODUCT BENEFITS

- Perfectly matched to 24 V LED flexible strips
- 5 years guarantee
- Very stable output power
- Quick and simple installation due to prewiring
- High efficiency and reliability
- Installation in very cold and hot environments

### AREAS OF APPLICATION

- Suitable for indoor and outdoor installations
- Facade and building illumination
- Ideal for illuminating public spaces
- Bathrooms, kitchens and outdoor areas
- Offices, shopping centers, hospitals, restaurants, hotels

E-number	Product name	GTIN (EAN)	V	V <sub>OUT</sub>	W	Hz	W	t <sub>inj</sub> <sup>2</sup>
	DR-PFM-30/220-240/24/P	4058075239980	220...240	24	30.0	50/60	-	50000 <sup>bl</sup>
	DR-PFM-60/220-240/24/P	4058075239913	220...240	24	60.0	50/60	-	50000 <sup>bl</sup>
	DR-PFM-100/220-240/24/P	4058075239937	220...240	24	100.0	50/60	-	50000 <sup>bl</sup>
	DR-PFM-150/220-240/24/P	4058075239975	220...240	24	150.0	50/60	-	50000 <sup>bl</sup>
	DR-PFM-250/220-240/24/P	4058075240032	220...240	24	250.0	50/60	-	50000 <sup>cl</sup>

Product name	T <sub>a</sub>	T <sub>c</sub>	PROTECTION CLASS	L x W x H [mm]	PRICE (EUR) <sup>3</sup>	No.
DR-PFM-30/220-240/24/P	-40...+50	80.0	II	148 x 40.0 x 32.0		1
DR-PFM-60/220-240/24/P	-40...+50	90.0	II	163 x 43.0 x 32.0		2
DR-PFM-100/220-240/24/P	-40...+50	80.0	I	197 x 63.0 x 38.0		3
DR-PFM-150/220-240/24/P	-40...+50	90.0	I	219 x 63.0 x 38.0		4
DR-PFM-250/220-240/24/P	-40...+50	85.0	I	233 x 74.0 x 42.0		5

<sup>1</sup> Refer to www.ledvance.com/guarantee for precise conditions | <sup>2</sup> a) At maximum T<sub>c</sub> = 80°C / 10% failure rate; b) At maximum T<sub>c</sub> = 90°C / 10% failure rate; c) At maximum T<sub>c</sub> = 85°C / 10% failure rate | <sup>3</sup> Recommended retail price excl. VAT

# LED DRIVER VALUE



Constant voltage LED driver

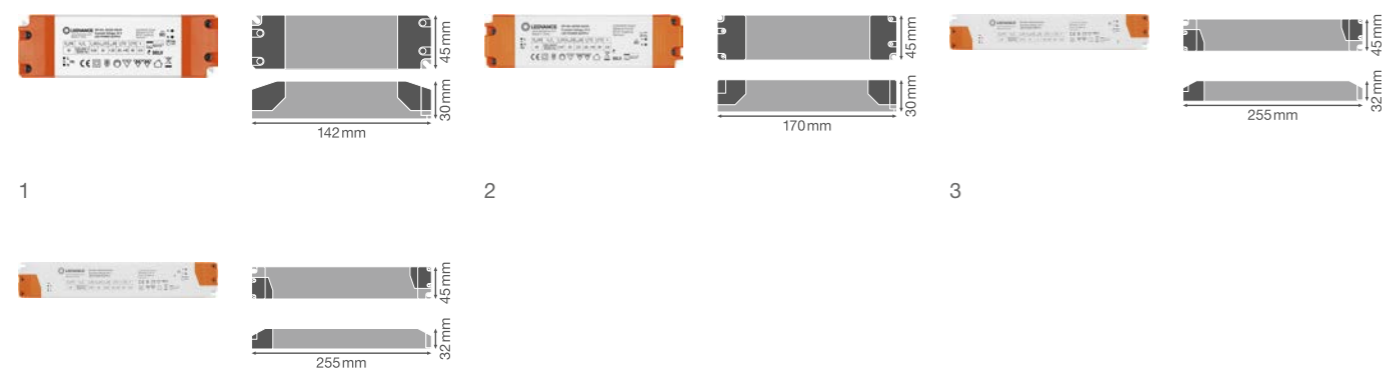

## PRODUCT BENEFITS

- Perfectly matched to 24 V LED flexible strips
- Excellent price/performance ratio
- 3 years guarantee
- Quick and simple installation
- Good efficiency and reliability

## AREAS OF APPLICATION

- Cove lighting, even in tight spaces
- Wallwasher effect lighting in living rooms, dining rooms, bedrooms, entrances
- For indoor SELV installations
- Offices, shopping centers, hospitals, restaurants, hotels

E-number	Product name	GTIN (EAN)	V	V <sub>OUT</sub>	W	Hz	W	t <sub>inj</sub> <sup>2</sup>
	DR-VAL-30/220-240/24	4058075240056	220...240	24	30.0	50/60	-	35000 <sup>a)</sup>
	DR-VAL-60/220-240/24	4058075240094	220...240	24	60.0	50/60	-	35000 <sup>a)</sup>
	DR-VAL-120/220-240/24	4058075240131	220...240	24	120.0	50/60	-	35000 <sup>b)</sup>
	DR-VAL-150/220-240/24	4058075240179	220...240	24	150.0	50/60	-	35000 <sup>c)</sup>

Product name	T <sub>a</sub>	T <sub>c</sub>	PROTECTION CLASS	L x W x H [mm]	PRICE (EUR)	No.
DR-VAL-30/220-240/24	-20...+45	85.0	II	142 x 45.0 x 30.0		1
DR-VAL-60/220-240/24	-20...+45	85.0	II	170 x 45.0 x 30.0		2
DR-VAL-120/220-240/24	-20...+40	90.0	II	255 x 45.0 x 32.0		3
DR-VAL-150/220-240/24	-20...+40	90.0	II	255 x 45.0 x 32.0		4

<sup>1</sup> Refer to [www.ledvance.com/guarantee](http://www.ledvance.com/guarantee) for precise conditions | <sup>2</sup> a) At maximum T<sub>c</sub> = 85°C / 10% failure rate; b) At maximum T<sub>c</sub> = 90°C / 10% failure rate; c) At maximum T<sub>c</sub> = 90°C / 12% failure rate | <sup>3</sup> Recommended retail price excl. VAT

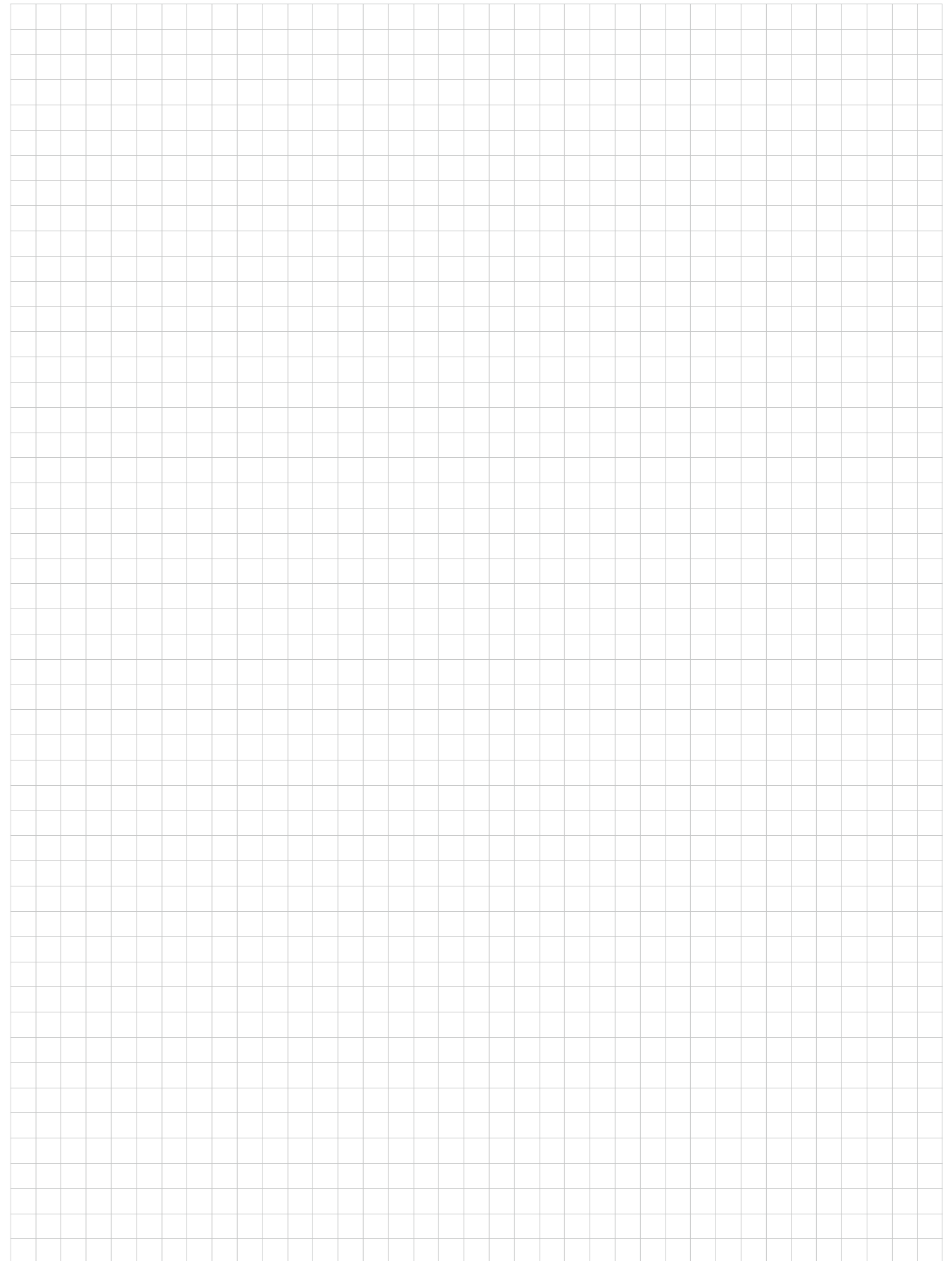

# THE LONGER THE SHORTER LED STRIP LENGTH DEPENDING ON SUPPLY LINE LENGTH<sup>1</sup>

The maximum length of an LED Strip varies from application to application and strongly depends on the supply line between the driver and the strip. Depending on the length and cross-section of this supply line, a voltage drop can be recorded which from a certain point has a negative effect on the performance of the LED Strips. The tables below provide guide values.

## MAX. FEED LENGTH – LED STRIPS SUPERIOR CLASS

Cable length (cross-section 0.5 mm <sup>2</sup> ) <sup>3</sup>	Max. LED Strip length at an ambient temperature of T <sub>a</sub> : 25 °C				
	<0.5 m	1 m	3 m	6 m	10 m
Product name	Product class				
LS SUP-500/9xx/5 IP00	9.0 m	8.9 m	8.5 m	8.1 m	7.5 m
LS SUP-800/9xx/5 IP00	7.1 m	6.9 m	6.6 m	6.2 m	5.6 m
LS SUP-1200/9xx/5 IP00	5.5 m	5.3 m	5.0 m	4.6 m	4.1 m
LS SUP-2000/9xx/3.5 IP00	3.5 m	3.2 m	3.0 m	2.6 m	2.2 m
LS SUP-500/9xx/5 IP67 <sup>2</sup>	9.0 m	8.9 m	8.5 m	8.1 m	7.5 m
LS SUP-800/9xx/5 IP67 <sup>2</sup>	7.1 m	6.9 m	6.6 m	6.2 m	5.6 m
LS SUP-1200/9xx/5 IP67 <sup>2</sup>	5.5 m	5.3 m	5.0 m	4.6 m	4.1 m
LS SUP-2000/9xx/3.5 IP67 <sup>2</sup>	3.5 m	3.2 m	3.0 m	2.6 m	2.2 m

## MAX. FEED LENGTH – LED STRIPS PERFORMANCE CLASS

Cable length (cross-section 0.5 mm <sup>2</sup> ) <sup>3</sup>	Max. LED Strip length at an ambient temperature of T <sub>a</sub> : 25 °C				
	<0.5 m	1 m	3 m	6 m	10 m
Product name	Product class				
LS PFM-300/8xx/5 IP00 <sup>4</sup>	20.3 m	19.7 m	19.0 m	18.5 m	18.0 m
LS PFM-600/8xx/5 IP00	14.0 m	11.3 m	10.3 m	9.5 m	8.5 m
LS PFM-1000/8xx/5 IP00	10.7 m	8.5 m	7.5 m	6.5 m	5.3 m
LS PFM-1500/8xx/5 IP00	8.5 m	7.3 m	6.5 m	5.3 m	4.5 m
LS PFM-2000/8xx/5 IP00	6.8 m	6.1 m	5.3 m	4.4 m	3.5 m
LS PFM-300/8xx/5 IP66 <sup>2,4</sup>	20.3 m	19.7 m	19.0 m	18.5 m	18.0 m
LS PFM-600/8xx/5 IP66 <sup>2</sup>	14.0 m	11.3 m	10.3 m	9.5 m	8.5 m
LS PFM-1000/8xx/5 IP66 <sup>2</sup>	10.7 m	8.5 m	7.5 m	6.5 m	5.3 m
LS PFM-1500/8xx/5 IP66 <sup>2</sup>	8.5 m	7.3 m	6.5 m	5.3 m	4.5 m
LS PFM-2000/8xx/5 IP66 <sup>2</sup>	6.8 m	6.1 m	5.3 m	4.4 m	3.5 m

## MAX. FEED LENGTH – LED STRIPS VALUE CLASS

Cable length (cross-section 0.5 mm <sup>2</sup> ) <sup>3</sup>	Max. LED Strip length at an ambient temperature of T <sub>a</sub> : 25 °C				
	<0.5 m	1 m	3 m	6 m	10 m
Product name	Product class				
LS VAL-300/8xx/5 <sup>4</sup>	17.7 m	17.3 m	17.0 m	16.5 m	15.6 m
LS VAL-600/8xx/5 <sup>4</sup>	13.2 m	12.8 m	12.5 m	12.0 m	11.2 m
LS VAL-1000/8xx/5 <sup>4</sup>	9.1 m	8.8 m	8.4 m	7.8 m	7.2 m
LS VAL-1400/8xx/5 <sup>4</sup>	13.9 m	13.6 m	13.1 m	12.2 m	11.2 m
LS VAL-300/8xx/5 IP65 <sup>2,4</sup>	17.7 m	17.3 m	17.0 m	16.5 m	15.6 m
LS VAL-600/8xx/5 IP65 <sup>2,4</sup>	13.2 m	12.8 m	12.5 m	12.0 m	11.2 m
LS VAL-1000/8xx/5 IP65 <sup>2,4</sup>	9.1 m	8.8 m	8.4 m	7.8 m	7.2 m
LS VAL-1400/8xx/5 IP65 <sup>2,4</sup>	13.9 m	13.6 m	13.1 m	12.2 m	11.2 m

## MAX. FEED LENGTH – LED STRIPS SUPERIOR CLASS TUNABLE WHITE

Cable length (cross-section 0.5 mm <sup>2</sup> ) <sup>3</sup>	Max. LED Strip length at an ambient temperature of T <sub>a</sub> : 25 °C				
	<0.5 m	1 m	3 m	6 m	10 m
Product name	Product class				
LS SUP-2000/TW/927-965/5 IP00	7.0	7.0	6.5	5.5	4.5
LS SUP-2000/TW/927-965/5/IP66 <sup>2</sup>	7.0	7.0	6.5	5.5	4.5

## MAX. FEED LENGTH – LED STRIPS PERFORMANCE CLASS RGBW

Cable length (cross-section 0.5 mm <sup>2</sup> ) <sup>3</sup>	Max. LED Strip length at an ambient temperature of T <sub>a</sub> : 25 °C				
	<0.5 m	1 m	3 m	6 m	10 m
Product name	Product class				
LS PFM-1000/RGBW/8xx/5 IP00	7.0	6.2	5.6	4.8	4.0
LS PFM-1000/RGBW/8xx/5/IP66 <sup>2</sup>	7.0	6.2	5.6	4.8	4.0

## MAX. FEED LENGTH – LED STRIPS VALUE CLASS RGB

Cable length (cross-section 0.5 mm <sup>2</sup> ) <sup>3</sup>	Max. LED Strip length at an ambient temperature of T <sub>a</sub> : 25 °C				
	<0.5 m	1 m	3 m	6 m	10 m
Product name	Product class				
LS VAL-500/RGB/5 IP00 <sup>4</sup>	10.0 m	9.6 m	9.1 m	8.7 m	7.7 m
LS VAL-500/RGB/5 IP65 <sup>4</sup>	10.0 m	9.6 m	9.1 m	8.7 m	7.7 m

**Summary of your Flex configuration**

LEDVANCE

**Flex**

Number of pos. 2

Length 1 phase 10m

Total length 10m

Power 120W

**Profile**

Length 1 phase A 10m

Length 1 phase B 10m

**Cover**

Length 1 phase A 10m

Length 1 phase B 10m

**Wiring Diagram**

**DID YOU KNOW?**

The configurator calculates the feeds for your individual LED Strip System based on your inputs. Give it a try at: [www.ledvance.com/led-strip-configurator](http://www.ledvance.com/led-strip-configurator)

<sup>1</sup> The shown values give an overview of the change in the maximum operation lengths as a function of the supply line length with a wire cross diameter of 0.5mm<sup>2</sup>. All values are based on a LED strip nominal voltage of 24VDC applied to the supply line. The supply line has to be designed according valid standards. | <sup>2</sup> When the LED strip will be extended by soldering, the installer is responsible to maintain the IP65 protection. | <sup>3</sup> LED strip connected at supply line wire with 500mm prewired cable. | <sup>4</sup> The brightness of resistor-controlled LED strips can decrease with increasing product length, due to the voltage drop on the resistors.



# COMPATIBILITY OVERVIEW

## FULL COMPATIBILITY OF LED STRIPS, DRIVERS, CONNECTORS AND PROFILES

LED STRIP	DRIVERS	CONNECTORS/ACCESSORIES	PROFILES
<b>SUPERIOR CLASS</b>	DR DALI-SUP-45/220-240/24 DR DALI-SUP-80/220-240/24 DR DALI-SUP-150/220-240/24 DR-SUP-30/220-240/24 DR-SUP-60/220-240/24 DR-SUP-100/220-240/24 DR-SUP-200/220-240/24 DR DIM-PFM-20/220-240/24/P DR DIM-PFM-40/220-240/24/P DR DIM-PFM-60/220-240/24/P DR DIM-PFM-100/220-240/24/P DR DIM-PFM-150/220-240/24/P DR DIM-PFM-250/220-240/24/P DR-PFM-30/220-240/24/P DR-PFM-60/220-240/24/P DR-PFM-100/220-240/24/P DR-PFM-150/220-240/24/P DR-PFM-250/220-240/24/P DR-VAL-30/220-240/24 DR-VAL-60/220-240/24 DR-VAL-120/220-240/24 DR-VAL-150/220-240/24	LS AY SUP-CP/P2/500 LS AY SUP-CSD/P2 LS AY SUP-CSW/P2/50 LS AY SUP-CSW/P2/500 LS AY SUP-CP/P3/500 LS AY SUP-CSD/P3 LS AY SUP-CSW/P3/50 LS AY SUP-CP/P3/500/P LS AY SUP-CSD/P3/P LS AY SUP-CSW/P3/50/P  LS AY PFM-CP/P2/500 LS AY PFM-CSD/P2 LS AY PFM-CSW/P2/50 LS AY PFM-CP/P2/500/P LS AY PFM-CSD/P2/P LS AY PFM-CSW/P2/50/P LS AY PFM-CP/P5/500 LS AY PFM-CSD/P5 LS AY PFM-CSW/P5/50 LS AY PFM-CP/P5/500/P LS AY PFM-CSD/P5/P LS AY PFM-CSW/P5/50/P LS AY VAL-CP/P4/500 LS AY VAL-CSD/P4 LS AY VAL-CSW/P4/50 LS AY VAL-CP/P4/500/P LS AY VAL-CSD/P4/P LS AY VAL-CSW/P4/50/P LS AY SUP-SE/P + SILICONE SEAL LS AY SUP-12/SE/P SILICONSEAL LS AY PFM-10/SE/PSILICONSEAL LS AY PFM-13/SE/P SILICONSEAL LS AY VAL-SE/P + SILICONE SEAL LS AY SUP-12/SMB LS AY PFM-8/SMB LS AY PFM-10/SMB LS AY PFM-13/SMB LS AY VAL-12/SMB	LS AY SUP-PF01/16X10/13/1 LS AY SUP-PFS01/16X10/13/0,015 LS AY-PW01/U/26X8/14/1 <sup>3</sup> LS AY-PW02/UW/39X26/14/1 <sup>3</sup> LS AY-PW03/U/26X26/14/1 <sup>3</sup> LS AY-PF01/UW/22X6/10/1 <sup>3</sup> LS AY-PF02/U/16X5/10/1 <sup>3</sup> LS AY-PF03/UW/25X7/12/1 <sup>3</sup> LS AY-PF04/U/17X7/12/1 <sup>3</sup> LS AY-PM01/UW/21.5X12/10/1 <sup>3</sup> LS AY-PM02/R/18X15.5/10/1 <sup>3</sup> LS AY-PM03/E/19X19/10/1 <sup>3</sup> LS AY-PM04/UW/23X15.5/10/1 <sup>3</sup> LS AY-PM05/U/17.5X14.5/10/1 <sup>3</sup> LS AY-PM06/E/18X18/12/1 <sup>3</sup>
LS SUP-500/5	•••••	•••••	••••• <sup>1</sup>
LS SUP-500/5/IP67	•••••	•••••	•••••
LS SUP-800/5	•••••	•••••	••••• <sup>1</sup>
LS SUP-800/5/IP67	•••••	•••••	•••••
LS SUP-1200/5	•••••	•••••	••••• <sup>1</sup>
LS SUP-1200/5/IP67	•••••	•••••	•••••
LS SUP-2000/3.5	•••••	•••••	••••• <sup>1</sup>
LS SUP-2000/3.5/IP67	•••••	•••••	•••••
<b>SUPERIOR CLASS TW</b>			
LS SUP-2000/TW/927-965/5	•••••	•••••	••••• <sup>1</sup>
LS SUP-2000/TW/927-965/5/IP67	•••••	•••••	••••• <sup>2</sup>
<b>PERFORMANCE CLASS</b>			
LS PFM-300/5	•••••	•••••	••••• <sup>1</sup>
LS PFM-300/5/IP66	•••••	•••••	••••• <sup>2</sup>
LS PFM-600/5	•••••	•••••	••••• <sup>1</sup>
LS PFM-600/5/IP66	•••••	•••••	••••• <sup>2</sup>
LS PFM-1000/5	•••••	•••••	••••• <sup>1</sup>
LS PFM-1000/5/IP66	•••••	•••••	••••• <sup>2</sup>
LS PFM-1500/5	•••••	•••••	••••• <sup>1</sup>
LS PFM-1500/5/IP66	•••••	•••••	••••• <sup>2</sup>
LS PFM-2000/5	•••••	•••••	••••• <sup>1</sup>
LS PFM-2000/5/IP66	•••••	•••••	••••• <sup>2</sup>
<b>PERFORMANCE CLASS RGBW</b>			
LS PFM-1000/RGBW/5	•••••	•••••	••••• <sup>1</sup>
LS PFM-1000/RGBW/5/IP66	•••••	•••••	•••••
<b>VALUE CLASS</b>			
LS VAL-300/5	•••••	•••••	•••••
LS VAL-300/5/IP65	•••••	•••••	•••••
LS VAL-600/5	•••••	•••••	•••••
LS VAL-600/5/IP65	•••••	•••••	•••••
LS VAL-1000/5	•••••	•••••	•••••
LS VAL-1000/5/IP65	•••••	•••••	•••••
LS VAL-1400/5	•••••	•••••	•••••
LS VAL-1400/5/IP65	•••••	•••••	•••••
<b>VALUE CLASS RGB</b>			
LS VAL-500/RGB/5	•••••	•••••	••••• <sup>1</sup>
LS VAL-500/RGB/5/IP65	•••••	•••••	••••• <sup>2</sup>

LED STRIPS

STRIP ACCESSORIES

PROFILES

DRIVERS

COMPATIBILITY

LED STRIPS

STRIP ACCESSORIES

PROFILES

DRIVERS

COMPATIBILITY

# LIGHTING CONTROL FROM OSRAM: DYNAMICS MEETS EFFICIENCY

## THE SYSTEM APPROACH TO GOOD LIGHT

Light management systems (LMS) comprise all the components needed for dynamic and intelligent lighting in addition to LED strips. These include LED drivers (CV) with DALI interfaces suitable for LED strips. Other components in light management systems also ensure that the LED strips are operated at high levels of comfort, convenience and energy efficiency. For example, light and motion sensors dim the light as soon as a room is lit by natural light, and only switch on the light if someone is in the room. Considerable energy savings can therefore be achieved.



Products of OSRAM GmbH, distributed by LEDVANCE

## OSRAM CONTROLLERS



	DALI PCU PUSHBUTTON CONTROLLER	DALI MCU DIGITAL ROTARY DIMMER	DALI MCU TW DIGITAL ROTARY DIMMER TUNABLE WHITE
<b>Product name</b>	DALI PCU	DALI MCU	DALI MCU TW
<b>GTIN (EAN)</b>	4052899955622	4008321189721	4052899465916
<b>Brief description</b>	<ul style="list-style-type: none"> <li>Manual dimming and switching of DALI luminaires via standard pushbutton</li> <li>Integrated DALI supply</li> <li>Integration into flush device boxes</li> <li>Parallel connection of up to 4 devices</li> </ul>	<ul style="list-style-type: none"> <li>Manual dimming and switching of DALI luminaires</li> <li>Integrated DALI supply</li> <li>Parallel connection of up to 4 devices</li> <li>Combination with covers of various manufacturers</li> </ul>	<ul style="list-style-type: none"> <li>Intuitive manual dimming, switching and color temperature setting of DALI luminaires with DALI Device Type 8 (DT8)</li> <li>Parallel connection of up to 4 devices</li> <li>Individual setting of minimum brightness level and color temperature range</li> </ul>
<b>L x W x H [mm]</b>	48 x 48 x 22	80 x 80 x 50	80 x 80 x 50



	DALI ACU BT DALI CONTROLLER WITH BLUETOOTH INTERFACE	DALIeco BT DALI CONTROLLER WITH BLUETOOTH INTERFACE	OT BLE DIM CONSTANT-VOLTAGE DIMMER WITH BLUETOOTH INTERFACE
<b>Product name</b>	DALI ACU BT	DALIeco BT ECO CI KIT (optional)	OT BLE DIM
<b>GTIN (EAN)</b>	4052899544819	4052899988781 4008321392091	4052899557833
<b>Brief description</b>	<ul style="list-style-type: none"> <li>Configuration and control via pushbutton and/or app</li> <li>Control of standard white or Tunable White light according to DALI Device Type 8 (DT8)</li> <li>Individual addressing of up to 4 groups</li> <li>Supports OSRAM DALI sensors</li> <li>Integration into flush device boxes</li> </ul>	<ul style="list-style-type: none"> <li>Configuration and control via pushbutton and/or app</li> <li>Control of standard white or Tunable White light according to DALI Device Type 8 (DT8)</li> <li>Individual addressing of up to 4 groups</li> <li>Supports OSRAM DALI sensors</li> <li>For luminaire integration or independent mounting with CI KIT</li> </ul>	<ul style="list-style-type: none"> <li>Control of LED modules in white, Tunable White, RGB or RGBW colors</li> <li>Supports systems based on the Casambi lighting control system</li> <li>Very low maintenance requirements</li> </ul>
<b>L x W x H [mm]</b>	49 x 48 x 22	108 x 30 x 21	172 x 42 x 20

## OSRAM CONTROLLERS



	DALIeco BT RTC DALI CONTROLLER WITH BLUETOOTH INTERFACE	DALI PRO CONT-4 RTC CONTROLLER (9TE)
<b>Product name</b>	DALIeco BT RTC	DALI PRO CONT-4 RTC
<b>GTIN (EAN)</b>	4062172016537	4008321710871
<b>Brief description</b>	<ul style="list-style-type: none"> <li>Like DALIeco BT, plus:</li> <li>Real-time clock for time-of-day-dependent automatic control of brightness and color temperature (HCL)</li> <li>Intuitive manual dimming, switching and color temperature setting</li> <li>4 configurable timers</li> </ul>	<ul style="list-style-type: none"> <li>Extremely flexible and configurable in many details</li> <li>Easy and intuitive control via app</li> <li>Connection of up to 4 DALI PROFESSIONAL controllers</li> <li>Extremely flexible, convenient configuration with PC software</li> <li>Supports DALI sensors</li> </ul>
<b>L x W x H [mm]</b>	108 x 30 x 21	90 x 160 x 62

## OSRAM DALI SENSORS

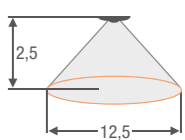
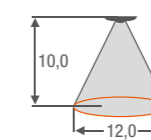

	DALI HIGHBAY ADAPTER	DALI HIGHBAY ADAPTER + HIGH BAY SENSOR	DALI HIGHBAY ADAPTER + VISION SENSOR
<b>Product name</b>	DALI HIGHBAY ADAPTER	DALI HIGHBAY ADAPTER HIGH BAY SENSOR	DALI HIGHBAY ADAPTER VISION SENSOR
<b>GTIN (EAN)</b>	4008321774132	4008321774132	4008321774132 4008321957047
<b>Brief description</b>	<ul style="list-style-type: none"> <li>DALI light sensor for on-top ceiling mounting</li> <li>Adjustable sensitivity (up to a height of 13 m)</li> </ul>	<ul style="list-style-type: none"> <li>DALI light sensor and motion detector</li> <li>Suitable for great installation heights</li> </ul>	<ul style="list-style-type: none"> <li>DALI light sensor and motion detector</li> <li>Very wide detection area</li> </ul>
<b>L x W x H [mm]</b>	139 x 118 x 37	139 x 118 x 37	139 x 118 x 37
<b>Ø x H [mm]</b>	—	—	116 x 40
<b>Mounting height</b>	—	—	4 6 8 10 13
<b>Presence</b>	—	—	—
<b>Motion</b>	—	—	10 12 12 12
<b>Vehicles</b>	—	—	10 12 12 12 18

## INPUT DEVICE



	DALI PUSHBUTTON COUPLER
<b>Product name</b>	DALI PRO PB Coupler
<b>GTIN (EAN)</b>	4008321496461
<b>Brief description</b>	<ul style="list-style-type: none"> <li>Power supply from DALI</li> <li>Standard pushbuttons/switches can be used</li> </ul>
<b>L x W x H [mm]</b>	42 x 42 x 20

Use case for LED Strip with light management system components

OT BLE DIM – for ADVANCED applications (decorative lighting)

- Products:**
- A OT BLE DIM
  - B LED DALI driver (constant voltage 24 V)
  - C FLEX TW/FLEX RGBW
  - D Switch
  - E DALI HIGHBAY ADAPTER Smartphone with Casambi App

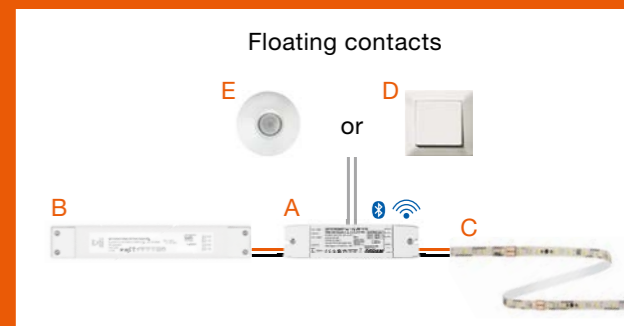

# ALWAYS INFORMED WITH THE LEDVANCE ONLINE PORTAL

Looking for information on our products and services? LEDVANCE keeps you up to date: at the wholesaler, through our sales staff and via our Customer Service Center (email: kundenservice@ledvance.com). An overview of our expertise pages, databases and tools is given here.

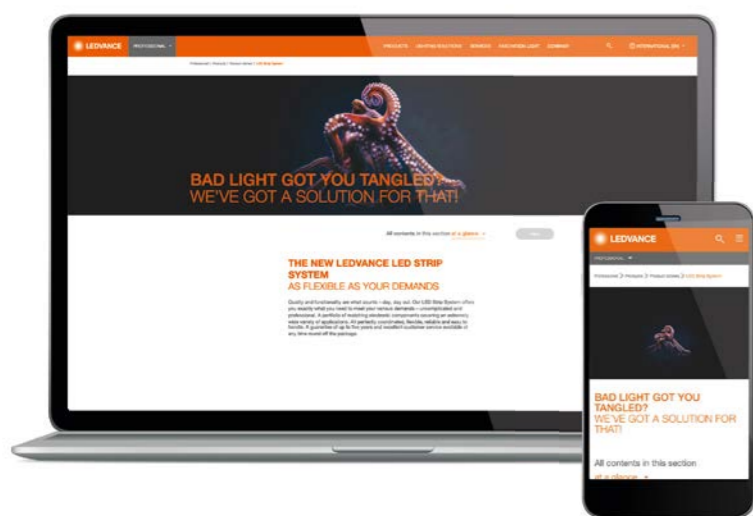

#### ▶ PERFECTLY INFORMED

You can find all the information, applications and segmentations relating to our new LED Strip System at [ledvance.com/led-strip](http://ledvance.com/led-strip)

#### ▶ REFERENCES PROVIDE INSPIRATION

A selection of some top lighting projects can be found at: [ledvance.com/projects](http://ledvance.com/projects)

#### ▶ LEDVANCE SERVICE-PLUS

Our specialized sales department supports and advises our commercial end customers – including face-to-face. Find out all you need to know at [ledvance.com/vam](http://ledvance.com/vam)

#### ▶ DOWNLOAD CENTER

Catalogs, compatibility overviews, brochures, and much more are available for you in our download center: [ledvance.com/download](http://ledvance.com/download)

#### ▶ OUR TOOLS FOR YOU

From the LED Strip System Configurator to the TCO calculator, you will find all the practical tools you need at [ledvance.com/tools](http://ledvance.com/tools)

#### ▶ SERVICE AT A GLANCE

You will find a summary of all of our service offerings at [ledvance.com/services](http://ledvance.com/services)

## NEW: THE ONLINE TRAINING PLATFORM

A host of application-oriented eLearnings for professional users, practical tips concerning installation, integrated standards check, planning tips, and much more.

Register and find out more at [training.ledvance.com](http://training.ledvance.com)



## LED STRIP SYSTEM CONFIGURATOR

This tool for configuring lighting systems with LED Strips helps you to quickly and reliably select the components you need. Give the LED Strip System Configurator a try! It will make your day-to-day work easier.\*

[ledvance.com/led-strip-configurator](http://ledvance.com/led-strip-configurator)

## LIGHT CALCULATION WITH DIALUX AND RELUX

DIALux and RELUX users can now also integrate LEDVANCE products really easily into their lighting planning. We also support users through consultancy, calculation and after-sales support.

\*The Fast Light Calculator is not intended to replace comprehensive, expertly executed light planning with DIALux, RELUX or another professional light planning software. The light distribution of a LED lamp can be influenced by a luminaire.

# GOOD LIGHT ALL ROUND THE FULL LEDVANCE RANGE

LEDVANCE is leading the fight against bad light in every area. That's good news for you because when it comes to luminaires and lamps, but also for electronic components and Smart for Residential products you have a competent partner in LEDVANCE on your side for your complex lighting projects. You can always rely on LEDVANCE for excellent brand quality, professional service and a good price/performance ratio.



## AESTHETICALLY FUNCTIONAL LUMINAIRES

The extensive luminaire portfolio from LEDVANCE covers virtually all professional and residential applications and delivers outstanding quality and functionality. What's more, its innovative SCALE design provides instant recognition, trust and flexibility – and was even a winner of the 2019 German Design Award.

## EACH LAMP A LIGHTING SOLUTION

LEDVANCE's lamp portfolio includes a wide choice of outstanding efficiency and durability: different shapes, base sizes, light colors and wattages as well as types with additional functions (e.g. sensors). Alongside a broad range of innovative LED lamps, LEDVANCE will continue to offer conventional halogen, energy saver, fluorescent and gas discharge lamps. A win-win situation for you and every one of your customers.

## FLEXIBLE LED STRIP SYSTEM

In addition to a large selection of flexible LED Strips and drivers, the LEDVANCE LED Strip System includes a

large number of matching profiles, covers, end caps and mounting brackets. In combination with a large range of luminous fluxes and light colors, the system allows bespoke lighting solutions to be created for virtually any indoor or outdoor ambient, cove or general lighting application. Easy to plan, easy to combine and easy to install – that's the principle here.

## SMART FOR RESIDENTIAL

The new Smart for Residential portfolio from LEDVANCE offers the comprehensive combination of innovation, quality, reliability and userfriendliness. LEDVANCE provides a suitable solution for a wide range of different needs for smart lighting.

## MORE INFORMATION AND CLEVER TOOLS

Go to [www.ledvance.com](http://www.ledvance.com) for more information on LEDVANCE's extensive product portfolio, clever apps and tools that will help you in your day-to-day work.

# MEANINGFUL ABBREVIATIONS NAMING IN THE LED STRIP SYSTEM

The names of the products reveal their properties:

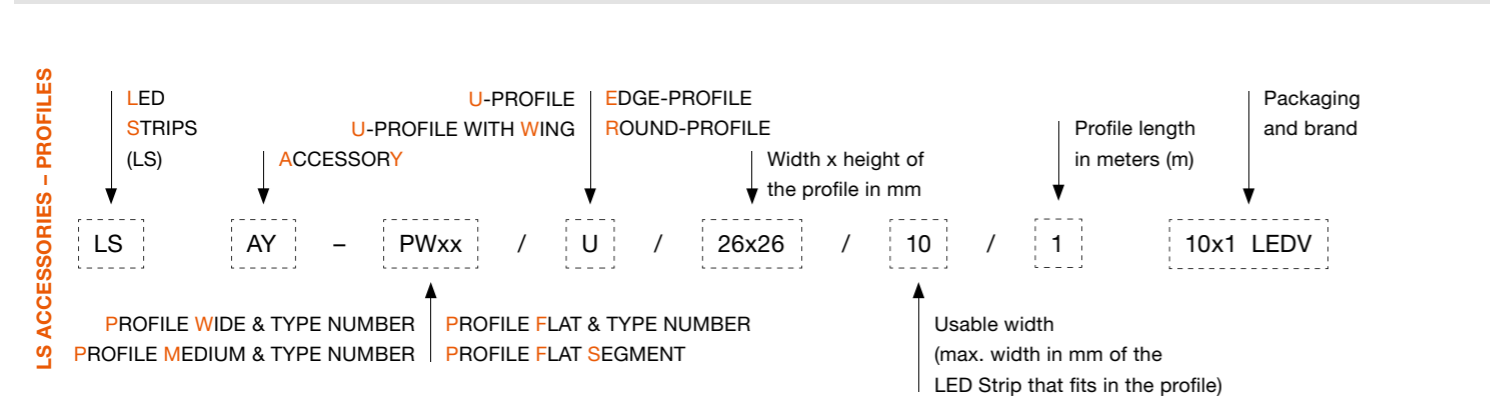
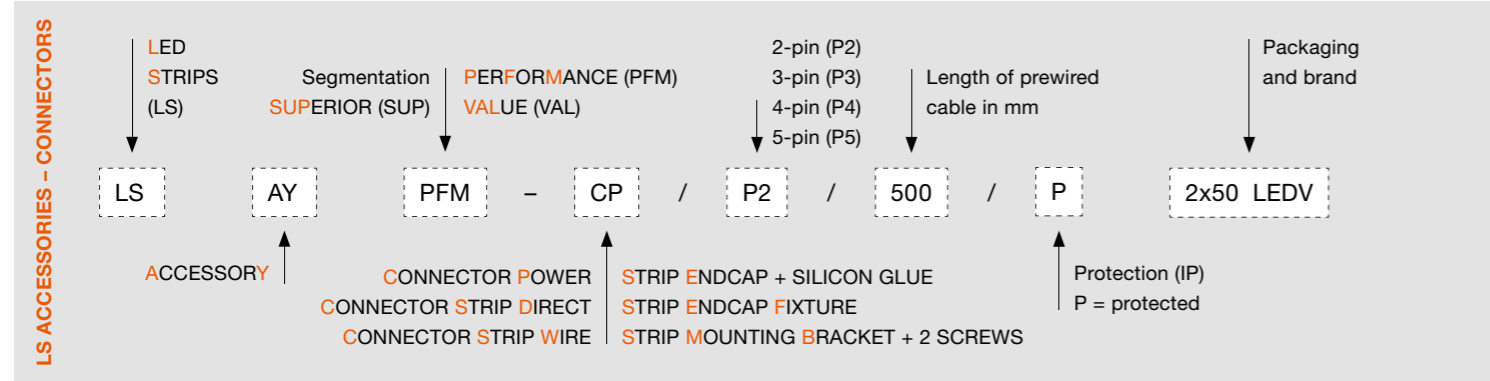
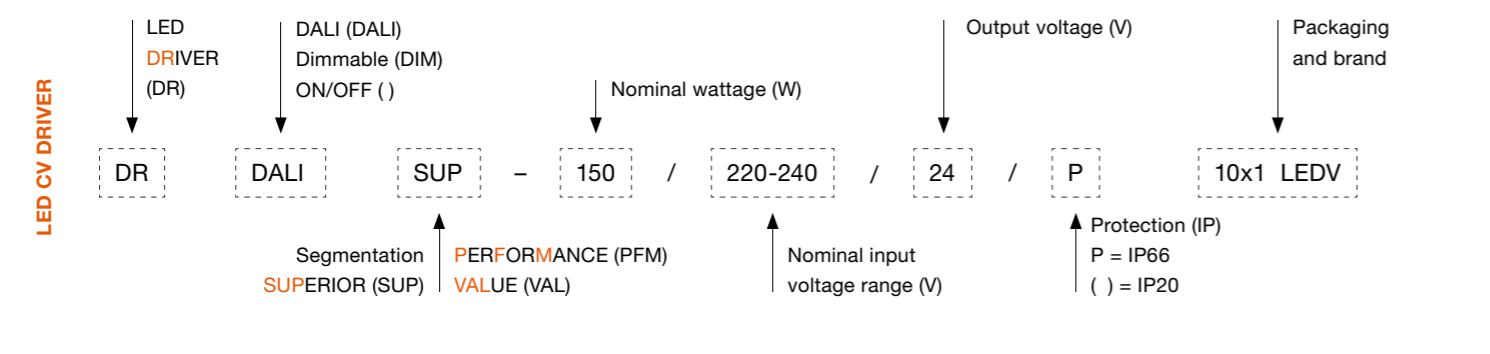
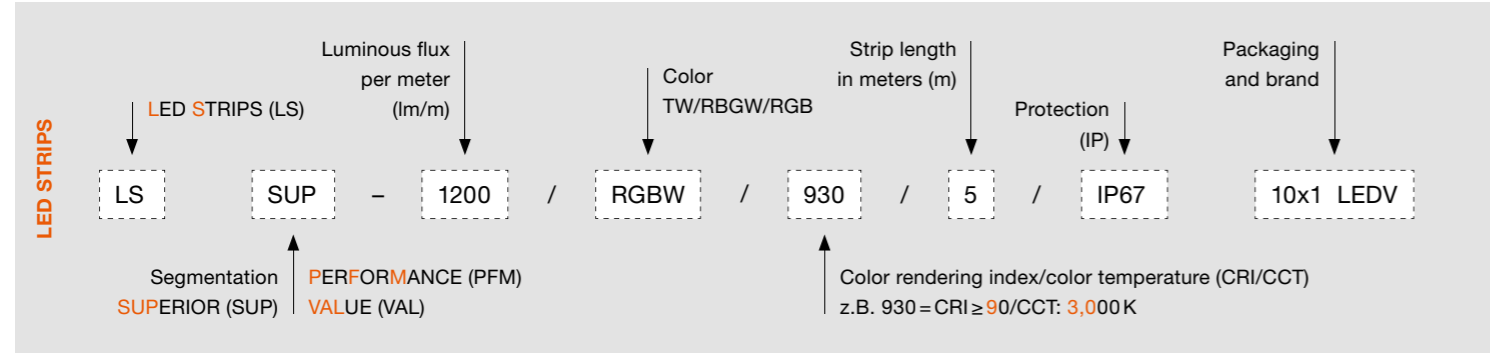

# SHEDDING LIGHT SYMBOLS AND ABBREVIATIONS

	Unprotected LED Strip		Luminous flux in lm		Voltage in V
	Protected LED Strip		Nominal wattage per meter in W		Output voltage in V
	Type of protection		Power in W		Operating frequency in Hz
	Color rendering index		Luminous efficacy		Ambient temperature range in °C
	MacAdam color consistency		Input voltage		Maximum operating temperature at the T <sub>c</sub> point in °C
	Dimmable		Number of LEDs per meter		Protection class
	Dimming range in %		LED pitch in mm		Fig. no.
	Short pitch		Beam angle in °		Recommended retail price excl. VAT
	UV resistance (acc. IEC 60068-2-5)		Energy efficiency class		Recommended retail price excl. VAT per meter
	Salt mist resistance (acc. IEC 60068-2-52)		Average period of use/life		Unit of Packaging (UOP)
	Color		Cable length		ESD protection required
	Color temperature in K		Length smallest unit		Must be installed and maintained only by qualified electricians
	Luminous flux per meter		Constant voltage		Do not throw away with household waste



# LEDVANCE

## ABOUT LEDVANCE

With offices in more than 50 countries and business activities in more than 140 countries, LEDVANCE is one of the world's leading general lighting providers for professional users and end consumers. Having emerged from the general lighting business of OSRAM GmbH, LEDVANCE offers a wide-ranging assortment of LED luminaires for a broad spectrum of application areas, intelligent lighting products for Smart Homes and Buildings, one of the largest LED lamps portfolios in the industry as well as traditional light sources.

LEDVANCE GmbH  
Parkring 29 – 33  
85748 Garching  
Germany

LEDVANCE is the expert partner for installers and lighting professionals. To match our new LED Strip System we also offer an extensive range of luminaires and a large portfolio of innovative LED lamps in excellent brand quality. Further information about our range of products and services is available online at [www.ledvance.com](http://www.ledvance.com)

Partners:



**LEDVANCE.COM**